

MTL SD range

Ultra-slim user-friendly devices for protecting electronic equipment and systems against surges on signal and I/O cabling.

- Range of ATEX Certified intrinsically safe surge protectors
- Ultra-slim space-saving design; easy installation
- Multistage hybrid protection circuitry – 20kA maximum surge current
- Range of voltage ratings – to suit all process I/O applications and HART Compatible
- High bandwidth, low resistance, RTD, PSTN and 3-wire transmitter versions available
- 10 year product warranty

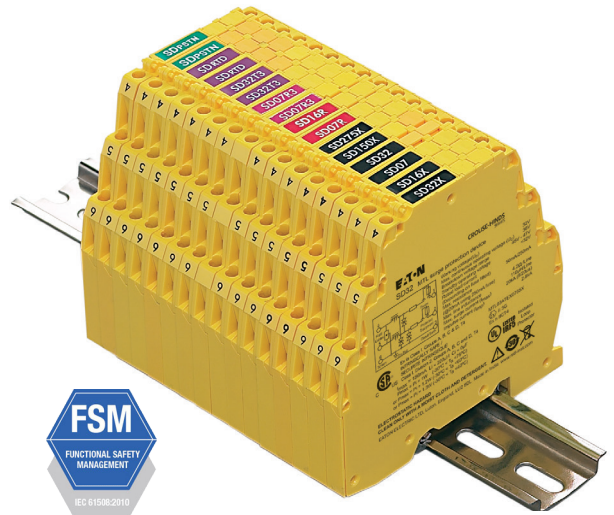

The SD range is a series of surge protection devices combine unparalleled packing densities, application versatility, proven reliable hybrid circuitry, simple installation and optional 'loop disconnect' facilities – features which make the range the ultimate surge protection solution for process equipment, I/O systems and communications networks.

The exceptionally high packing densities are the consequence of an ultra slim 'footprint' for individual modules which can thus 'double-up' as feedback terminals. Each module provides full hybrid surge protection for 2 and 3 wire loop protection.

Modules with a comprehensive range of voltage ratings cover all process related signals such as RTDs, THCs, 4 to 20mA loops, telemetry outstations, shut-down systems and fire and gas detectors.

Optional 'loop disconnect', is a feature which allows commissioning and maintenance to be carried out without removal of the surge protection device. This facility is provided by the SD07, SD16, SD32 and SD55 units. In addition, a third connection on the field and safe side of the protector is provided in order to terminate screens safely.

For three wire applications the specially designed SDRTD (Resistance Temperature Detector) and the SD32T3, (for separately powered 4-20mA loops) provide full 3-wire protection in a single compact unit. The recommended choice for the protection of 3-wire pressure transducers on low power circuits is the SD07R3.

For higher bandwidth applications, the SDR range has been developed to meet the demands of today's highest speed communication systems.

120V and 240V AC versions are available for I/O and power supplies up to three Amps of load current and telephone networks can be protected by the SDPSTN.

One simple manual operation clamps modules securely onto DIN rail, which automatically provides the essential high-integrity earth connection.

'Top-hat' (T-section) DIN rail is generally suitable for mounting SD modules although for adverse environments, a specially-plated version is available. A comprehensive range of mounting and earthing accessories can also be supplied, see page 7 for further details.



Powering Business Worldwide

Eaton Electric Limited,
Great Marlings, Butterfield, Luton
Beds, LU2 8DL, UK.
Tel: + 44 (0)1582 723633 Fax: + 44 (0)1582 422283
E-mail: mtlenquiry@eaton.com
www.mtl-inst.com

© 2025 Eaton
All Rights Reserved
Publication No. EPS 901-107 Rev Z
January 2025

Guide to applications and selection

The SD range of SPDs includes models for almost all possible applications operating at voltages up to 250V AC. The optional 'fuse/disconnect' package provides both fused protection against fault currents and a convenient method of isolating field circuitry from protected circuitry without needing additional disconnect terminals. The standard fuse (which is replaceable) is rated 250mA with 50mA fuses also being available by special request. Where only the disconnect feature is required, solid links can be used.

As an example, this feature is of particular value in applications in which an SPD is used with a bulk power supply feeding

multiple loops. The individual module fuse prevents a fault or follow on current on one loop disrupting the power supply to the others. Also, loops can be removed from the circuit for maintenance reasons or added without needing additional disconnect terminals.

The following guide to selection suggests the most suitable SDs for a number of specific applications. For technical information, see the detailed specifications on the back page of this publication (some field circuit protection is shown for completeness).

Analogue inputs (high-level)

2-wire transmitters, 4-20mA, conventional and smart

The SPDs recommended for use with 'conventional' and 'smart' 4-20mA transmitters (fed by a well-regulated supply) are the SD32 and SD55, the choice depending upon the maximum working voltage of the system (32V and 55V respectively). The diagram illustrates a prime example of an application for which the fuse/disconnect facility is particularly useful, however, both models are available in 'X' versions without the optional fuse/disconnect feature.

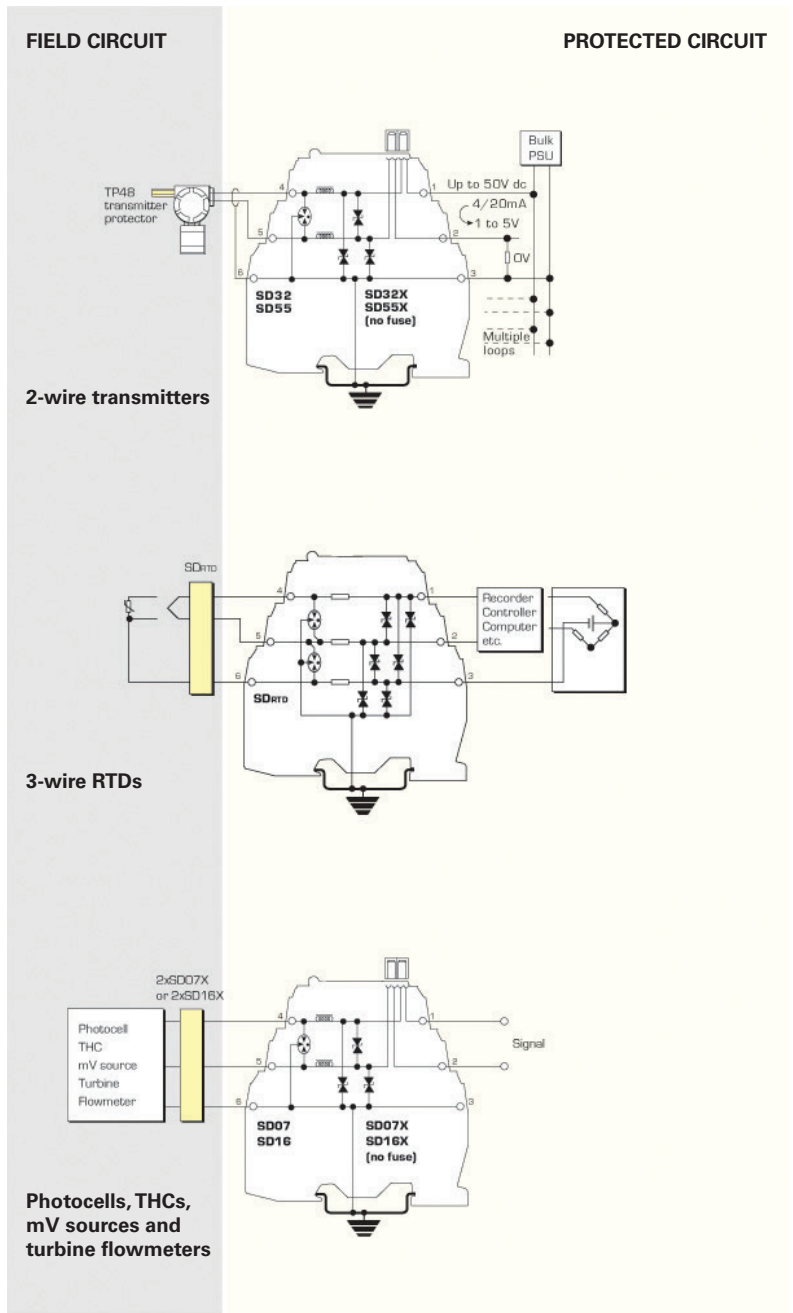

Analogue inputs (low-level)

RTDs

These applications are best served using the SDRTD. For optimum accuracy, the energising current should be chosen to ensure the voltage across the RTD does not exceed 1V over the full measurement range. When using a PT100 device, we recommend an energising current of 1mA.

Photocells, THCs, mV sources and turbine flowmeters

The SD07 or SD16 (depending upon the operational voltage) are the favoured choices for this application. SD07X and SD16X are also suitable.

MTL SD range

January 2025

Analogue outputs

Controller outputs (I/P converters)

For this application, the recommendations are the SD16, SD32 and SD55 (and the equivalent 'X' versions), the final choice depending upon the operating voltage.

Digital (on/off) inputs

Switches

Suitable SPDs for switches include the SD07, SD16, SD32 and SD55 modules – the choice depending upon the operating voltage of the system. The 'X' versions of these are also suitable.

Digital (on/off) outputs Alarms, LEDs, solenoid valves, etc

Alarms, LEDs, solenoid valves, etc

The recommended choice for this application is the SD32 or SD32X.

Telemetry (PSTN)

Telemetry outstations

The SDPSTN has been designed specifically for the protection of signals transmitted on public switched telephone networks.

AC supplied equipment

PLC, I/O systems

For systems on 110-120V ac, the SD150X is the recommended choice and for 220-240V ac systems, the SD275X is recommended.

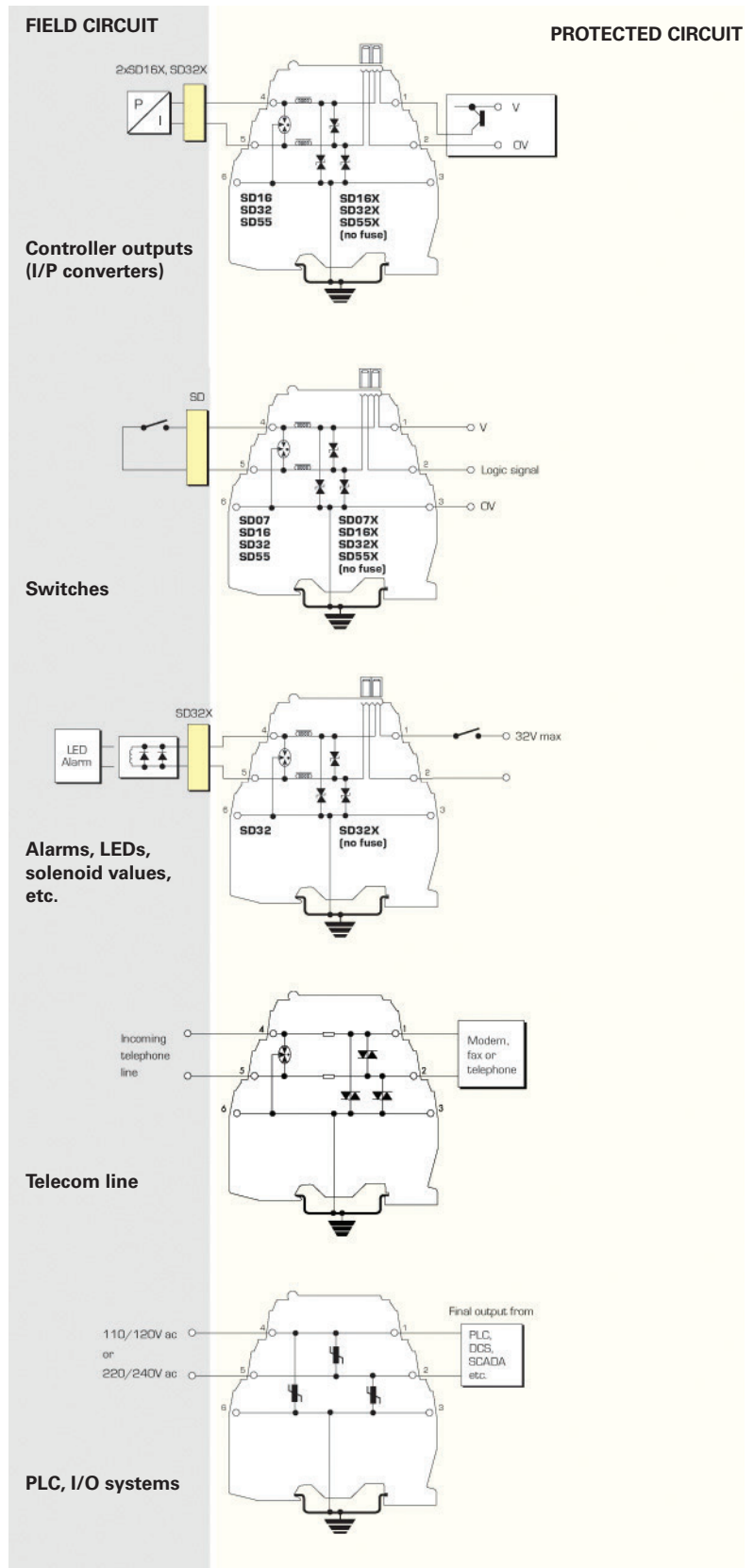

Transmitter and sensor protection

Transmitters and sensors are widely used in highly exposed areas and where lightning damage is common. In many cases, the ideal solution for 2-wire transmitters or sensors is the TP48 which mounts directly onto the transmitter housing via spare cable entries. Where these entries are not available or 3-wire devices are used, the compact design and simple installation of the SD range makes it the obvious choice for transmitter protection.

The SDs within the junction box should be installed no further than one metre away but as close as possible to the sensor or

transmitter they are protecting. A bond is required from the general mass of steelwork to the sensor or transmitter housing either using a flat short braid or a cable of at least 4mm² cross sectional area. In most instances this bond is automatically made by fixing the metallic transmitter housing to the plant structure. This bond ensures the voltage difference between the signal conductors and the transmitter housing is below the transmitter's insulation rating. Please note that the transmitters or sensors are connected to the 'Protected Equipment' terminals of the SD and not the 'Field Cables'.

2-wire transmitters or sensors

4-20mA transmitters, conventional and smart

Where the TP48 is not an acceptable solution, either because of technical suitability or difficulties in mounting, the SD16X, SD32X and SD55X are an excellent alternative.

3-wire transmitters or sensors

Vibration Sensors and 4-20mA loop process control systems invariably require three wire connections, when powered from an external source.

This may be accomplished in one unit by using the SD32T3 three terminal Surge Protection Device (SPD).

Because the SD32T3 protects all three conductors within the same unit, higher protection is achieved, as the SPD hybrid circuitry is common to all three wires.

The SD07R3 is available for the protection of 3-wire pressure transducers on low power circuits.

4-wire transmitters or sensors

Flow meters, level detectors, etc.

4-wire systems such as level detectors require two SDs, one for the supply and the other for the transmitter output. Generally the voltages across the pairs are similar and so the recommended choice would be a pair of SD16X, SD32X or SD55Xs. However, mains powered transmitters should be protected with an SD150X or 275X (depending upon supply voltage) for the supply inputs.

Loadcells are catered for by MTL Surge Technologies' LC30 which is suitable for both 4- and 6-wire load cells.

SD PROTECTED FIELD CIRCUIT

TO HOST CIRCUIT

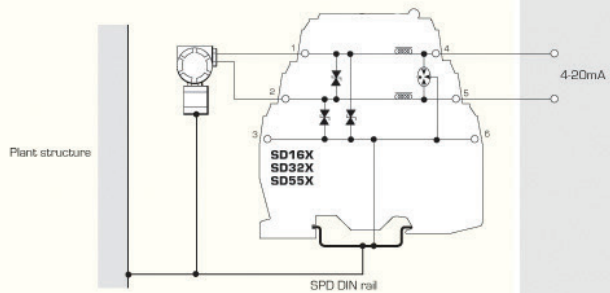

2-wire transmitter or sensor

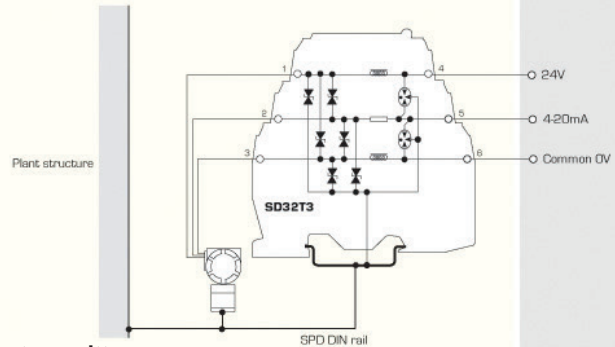

3-wire transmitter or sensor

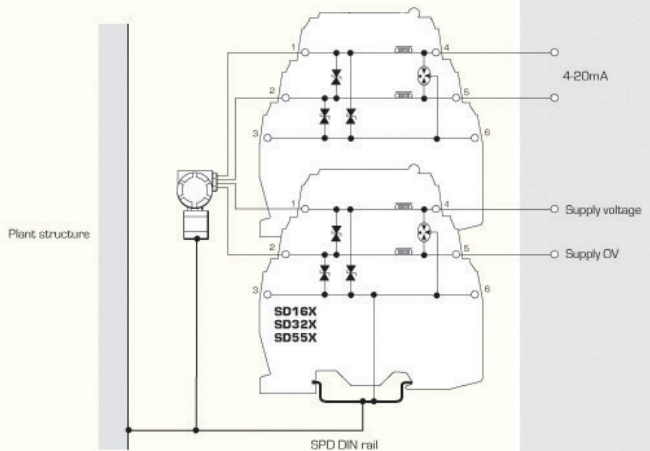

4-wire transmitter or sensor

Communication systems protection

High speed data links between buildings or one part of a plant to another have become more common with the widespread use of smart transmitters and the increase in unmanned installations. The SD range has an SPD suitable for all process I/O applications

with a choice of low resistance units, high bandwidth and a variety of voltage variants. The SDR range has been specially designed to meet the requirements for high speed data links with an extremely high bandwidth.

Communication systems

RS232, RS422, RS485

The recommended choice for these applications is the SD16R or SD32R depending on the maximum driver signal.

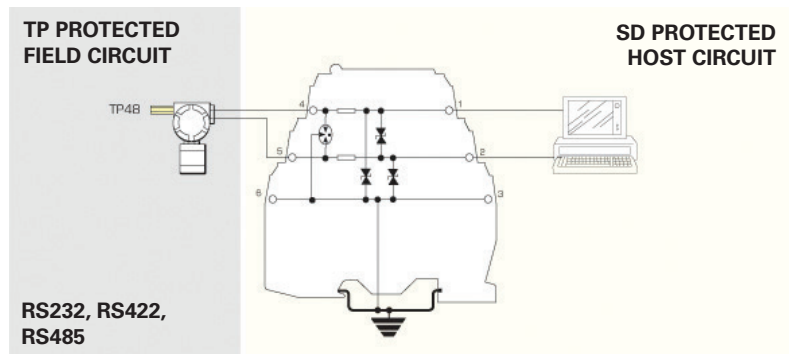

Bus powered systems

There are a variety of bus powered systems specially designed for the process industry. The ideal surge protection device for these systems is the SD32R as it has a very high bandwidth and a modest in-line resistance.

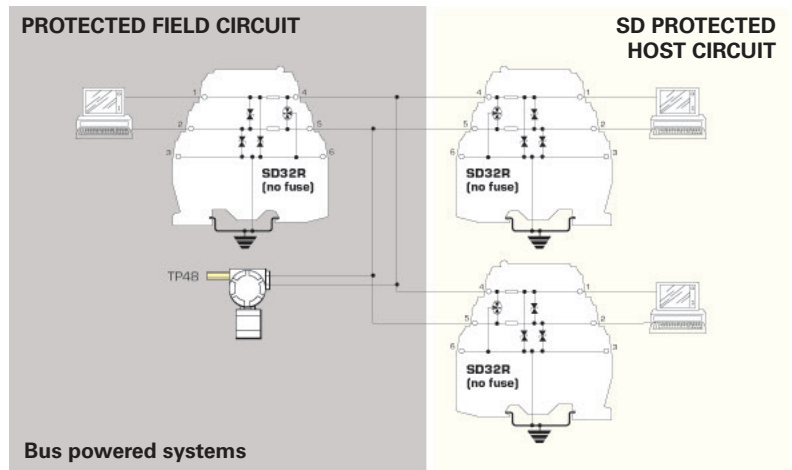

Typical Applications

Table 1 shows suitable SD devices for different applications. In some applications alternative devices may be used, for example, where lower in-line resistance or a higher voltage power supply is used.

MTL Surge Technologies has operationally tested the recommended SD range with representative highways listed but no formal approval for their use in systems by the respective bodies has been sought.

Table 1

Application	Preferred SPD	Alternative
Allen Bradley Data Highway Plus	SD16R	
HART	SD32X	SD32, SD32R
Honeywell DE	SD32X	SD32, SD32R
LonWorks FFT-10 LPT-10 TP-78 IS78†	SD32R SD55R SD07R SD32R	
Modbus ' & Modbus Plus (RS485)	SD16R	
PROFIBUS DP	SD07R	SD16R
RS232	SD16	SD16X
RS422	SD07R	
RS423	SD07R	
RS485	SD07R	

Hazardous area applications

Zone 0/Zone 1

The dangers from lightning induced sparking in Zone 0 are considered real enough to require preventative measures. IEC 60079-14 (1996-12) Electrical apparatus for explosive gas atmospheres Part 14: Electrical installations in hazardous areas (other than mines) stresses the importance of SPDs in hazardous areas. An outdoor installation, where there is a high likelihood of both lightning induced transients and combustible gases, requires the installation of SPDs to prevent possible ignition of the gases. Areas seen particularly at risk include flammable liquid storage tanks, effluent treatment plants, distillation columns in petrochemical works and gas pipelines.

SPDs for transmitter protection should be installed in Zone 1 but sufficiently close to the Zone 0 boundary to prevent high voltages entering Zone 0. The distance from the SPD to Zone 0 should be less than one metre where possible. However, in practice the SPD would normally be mounted on the transmitter or sensor housing which usually lies in Zone 1 and is very close to Zone 0. Because there is only a very small free volume, the SD range is suitable for mounting in flameproof or explosion proof enclosures.

Zone 2

The SD range is suitable for protecting electrical circuits in Division 2, Zone 2 and can be used without affecting the safety aspects of the circuit. Non-incendive (low-current) circuits can be protected using any SD range unit mounted in either the safe or hazardous area including those with the fuse disconnect facility. Non arcing (high current) circuits can also be protected except that SPDs with the fuse disconnect facility may only be mounted in the safe area. For use in these circuits the units must be mounted in a suitable enclosure, normally the minimum requirements are IP54 and 7Nm resistance to impact. The SD range is ATEX & IECEx certified as being suitable for this purpose.

Certification

Introducing surge protection into Intrinsically Safe (IS) circuits is trouble free as long as the current and power parameters are not exceeded. In the SD range, the SD**X, SD**R, SD**R3, SDRTD and SD**T3 all have ATEX certification for use in IS circuits located in Zones 0, 1 or 2. The certification parameters for the SD**X and SD**T3 are:

Ex ia IIC T4 Ga, Li = 0.22mH

- $I_i = 260\text{mA}$ for U_i up to 20V
- $I_i = 175\text{mA}$ for U_i up to 26V
- $I_i = 140\text{mA}$ for U_i up to 28V
- $I_i = 65\text{mA}$ for U_i up to 60V

The certification parameters for the SD**R, SD**R3 and SDRTD are:

Ex ia IIC T4 Ga, Li = 0

- $I_i = 260\text{mA}$ for U_i up to 60V

The power rating for each of these is dependent on the table shown below.

- $P_i = 1\text{W}$ (-30°C to +75°C)
- $P_i = 1.2\text{W}$ (-30°C to +60°C)
- $P_i = 1.3\text{W}$ (-30°C to +40°C)

The SD** range is classified as simple apparatus and are intended for use in Zone 2 or safe areas only, because their fuses are not fully encapsulated.

All of the models in the SD range (except SD150X & SD275X) are ATEX and IECEx certified for mounting in Zone 2.

Installation

Positioning

The SDs should be mounted on the field wiring side to ensure that any surges entering from the field do not damage any intrinsically safe barriers or galvanic isolators in the system. The SDs and IS interfaces should be mounted close to each other but on separate DIN rails in order to maintain the required 50mm clearance between safe area and hazardous area terminals.

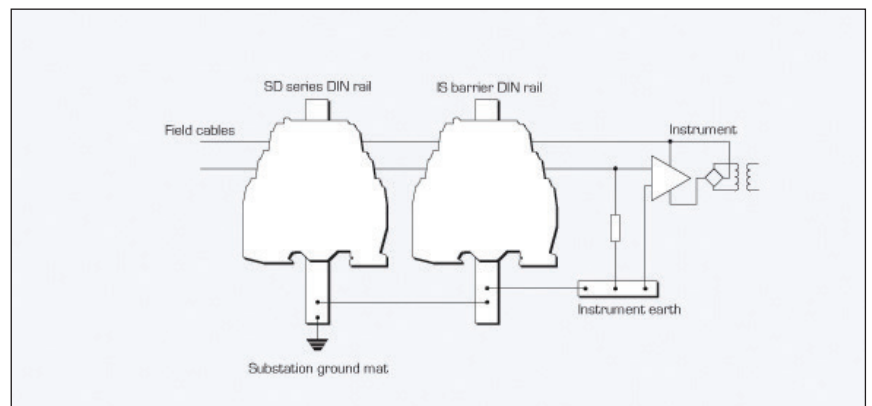

Earthing

The recommended earthing for field mounted devices has been illustrated previously but it is the earthing at the control panel that is more critical as there are usually a number of earthing systems, each with their own requirements. The earthing system illustrated here replaces the instrument 0V bond, the control system PSU bond and the IS earth with one single earth connection to meet all the design requirements and give the most effective protection against the effects of lightning induced surges.

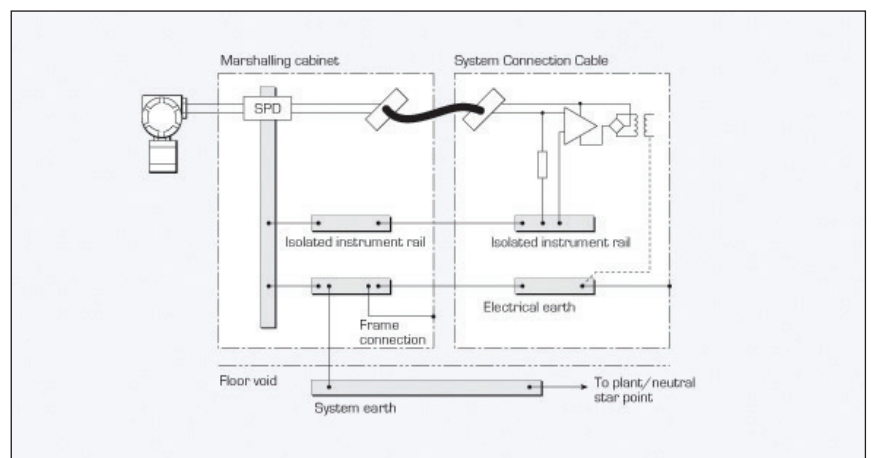

SD range mounting kits and accessories

The SD range has a full range of mounting kits and accessories to simplify installation and tagging of individual loops. Insulating spacers (ISP7000) are available to allow mounting of the units onto backplanes without compromising correct earthing practice. These are placed at regular intervals along the rail or at each end as required. Earth connections can be made to the DIN rail via the earth terminal (ETL7000). Weatherproof enclosures are also available with all the necessary mounting accessories to install the SD range of surge protection devices.

Mounting accessories

ISP7000	Insulating spacer
THR2	Standard DIN rail, 35mm x 7.5mm
THR7000	T-section DIN rail, specially nickel plated, 35mm x 7.5mm, 1m length

Earthing/earth rail accessories

ETL7000	Earth terminal, DIN rail mounted
IMB57	Insulated mounting block (two needed)
ERB57S	Earth rail bracket, straight
ERB57O	Earth rail bracket, offset
ERL7	Earth rail, 1m length
ETM7	Earth terminal, pack of 50

Tagging accessories

TAG57	Tagging strip, 1m length
TGL57	Tagging strip labels, set of 10 x 0.5m
BRI7000	Barrier identifier
BIL7000	Barrier identification labels, sheet of 120
BIL7000L	Barrier identification labels, A4 sheet of 126

Enclosures

DX070	Enclosure for up to 9 x SD range SPDs
DX170	Enclosure for up to 22 x SD range SPDs

Accessories (replacement)

SD-F25	Replaceable fuse pack - 250mA standard (available in packs of 5)
RFA7050	Replaceable fuse pack - 50mA special (available in packs of 5)
RLA7000	Solid Link (available in packs of 5)

Two tagging systems are available. One consists of tagging strips (TAG57) with labels (TGL57) mounted on posts (IMB57) at each end of a row of surge protection devices (SPDs). The other consists of separate tagging identifiers (BRI7000) mounted on the tops of individual SPDs. Both methods can be used conjointly. Replaceable fuses or solid links are available in packs of 5 (SD-F25, SD-F05 and SD-LNK).

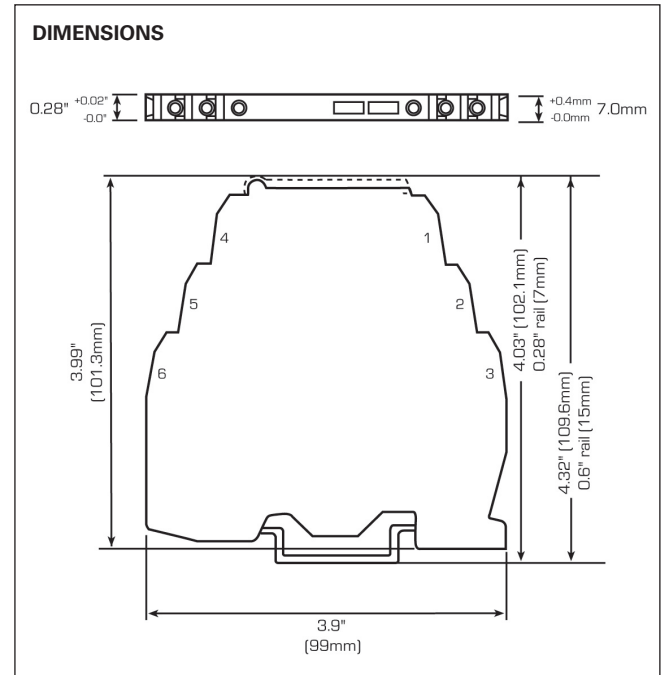

SIL information

Please refer to the Safety Manual at www.mtl-inst.com

MTL SD range

January 2025

SPECIFICATION

All figures typical at 77°F (25°C) unless otherwise stated

Protection

Full hybrid line to line
Each line to screen/ground

Max discharge surge current (I_{max}) (8/20μs)

20kA (8/20μs)
6.5kA (SD150X and SD275X only)

Nominal discharge surge current (I_{sn})

5kA (8/20μs)

Lightning impulse current (I_{imp}) (10/350μs)

2.8kA
1.0kA (SD150X and SD275X only)

Response time

<1ns

RTD resistance range (SDRTD)

10 to 1500Ω

Degradation accuracy (SDRTD at 1mA)

0.1% (RTD resistance > 100Ω)
0.1W (RTD resistance < 100Ω)

Ambient temperature

-40°C to +80°C / -40°F to 176°F storage
-40°C to +80°C / -40°F to 176°F working
For IS working applications:
 $P_i = 1.0W$ (-30°C to +75°C / -22°F to 167°F)
 $P_i = 1.2W$ (-30°C to +60°C / -22°F to 140°F)
 $P_i = 1.3W$ (-30°C to +40°C / -22°F to 104°F)

Humidity

5 to 95% RH (non-condensing)

Category tested

A2, B2, C1, C2, C3, D1

Overstressed fault mode in=3kA

12kA
9kA (SD150X and SD275X only)

Impulse durability (8/20μs)

10kA
6.5kA (SD150X and SD275X only)

Terminals

2.5mm² (12 AWG)

Mounting

T-section DIN-rail 35 x 7.5 or 35 x 15mm rail
(1.38" x 0.3" x 0.6")

Weight

70g approximately (2.5oz)

Case flammability

UL94 V-2

AC durability

1A_{rms}, 5T

Service conditions

80kPa - 160kPa
5% - 95% RH

EMC compliance

To Generic Immunity Standards,
EN 61326-1, part 2 for industrial environments

R&TTE compliance

EN 61326-1, EN 41003 : 1999
EN 60950 - 1 : 2006
(not applicable to SD150X and SD275X)

LVD compliance

SD150X & SD275X
EN 60950 - 1 : 2006, EN 61010 : 2010
SDPST
EN 41003 : 1999

Compliance

IEC/EN 61643-21
AS 1768:2021

ANSI/IEEE testing

C62.41-1-2002
C62.41-2-2002
C62.45-2002

Model	Nominal voltage+ (U _n)		Nominal current (I _n) (mA)	Series resistance (Ω/line)	Max. leakage current (μA)	Rated voltage *MCOV (U _c)	Voltage protection level (U _p) @ 1kV/μs (V)	Residual voltage @ i _{sn} (V)	Bandwidth (frequency) (G)	Special feature	
	(Vdc)	(Vac)									
SD07	7	5	250	4.2†	500	7.7	<12	30	25kHz	Fuse disconnect	
SD16	16	11	250	4.2†	5	17	<25	40	25kHz	Fuse disconnect	
SD32	32	22	250	4.2†	5	36	<45	60	25kHz	Fuse disconnect	
SD55	55	38	250	4.2†	5	62	<90	100	25kHz	Fuse disconnect	
SD07R	7	5	400	2.7	500	7.7	<12	30	50MHz	High bandwidth	
SD16R	16	11	400	4.7	5	17	<25	40	50MHz	High bandwidth	
SD32R	32	22	400	10	5	36	<45	60	50MHz	High bandwidth	
SD55R	55	38	400	10	5	62	<90	100	50MHz	High bandwidth	
SD07X	7	5	400	2.2	500	7.7	<12	30	25kHz	Low resistance	
SD16X	16	11	400	2.2	5	17	<25	40	25kHz	Low resistance	
SD32X	32	22	400	2.2	5	36	<45	60	25kHz	Low resistance	
SD55X	55	38	400	2.2	5	62	<90	100	25kHz	Low resistance	
SD32T3	32	22	400	2.2 [^]	5	36	<45	75	720kHz	3 Terminal	
SD07R3	7	5	400	2.7	500	7.7	<12	30	50MHz	3 Terminal	
SD16R3	16	11	400	4.7	5	17	<25	40	50MHz	3 Terminal	
SD32R3	32	22	400	10	5	36	<45	60	50MHz	3 Terminal	
SD55R3	55	38	400	10	5	62	<90	100	50MHz	3 Terminal	
SDRTD	1	0.75	10<	2.7	0.3	5	<12	38	50MHz	3-wire RTD	
SDPSTN	162	114	550	4.7	5	175	<200	235	4MHz	PSTN	
					ac rms	dc	ac rms				
SD150X	150	120	3A‡	0.1	50	170	130	<400	450	--	High current
SD275X	320	240	3A‡	0.1	50	360	275	<700	850	--	High current

Note: all figures are typical at +25°C unless otherwise stated; *standard fuse; †over full working temperature range; ‡at 20mA with a 250mA standard fuse; †these units need external 3A fuses; ^Signal; **Power & Common; <maximum energizing current depends upon RTD resistance. See page 2 for details.

Products highlighted in blue are ATEX certified Ex ia IIC T4 Ga.

Approvals

(for the latest certificate information, see www.mtl-inst.com/certificates)

To order -

Order by module, as listed in the specification table and/or accessory part numbers, as defined on page 7.



Powering Business Worldwide

Eaton Electric Limited,
Great Marlings, Butterfield, Luton
Beds, LU2 8DL, UK.
Tel: + 44 (0)1582 723633 Fax: + 44 (0)1582 422283
E-mail: mtlenquiry@eaton.com
www.mtl-inst.com

© 2025 Eaton
All Rights Reserved
Publication No. EPS 901-107 Rev Z 200125
January 2025

EUROPE (EMEA):
+44 (0)1582 723633
mtlenquiry@eaton.com

THE AMERICAS:
+1 800 835 7075
mtl-us-info@eaton.com

ASIA-PACIFIC:
+65 6 645 9888
sales.mtlsing@eaton.com

The given data is only intended as a product description and should not be regarded as a legal warranty of properties or guarantee. In the interest of further technical developments, we reserve the right to make design changes.