

Low-voltage power distribution and control systems > Switchboards >

Integrated Facility System switchboards

Contents

General Description	21.5-2
Application Considerations and Definitions	21.5-2
Product Overview	21.5-5
Devices	21.5-6
Circuit Breakers and Fusible Switches— Chassis Mounting	21.5-6
Power Xpert Release Trip Unit for Insulated Case Circuit Breakers	21.5-10
Power Xpert Release Trip Unit for Molded Case Circuit Breakers	21.5-11
Metering and Monitoring Devices	21.5-13
Surge Protective Devices	21.5-16
Distribution Section Devices	21.5-17
Layouts and Dimensions	21.5-19
Integrated Facility System (IFS) Switchboards Layout Guide	21.5-19



EATON

Powering Business Worldwide



More about this product
[Eaton.com/switchboards](https://www.eaton.com/switchboards)



Complete library of design guides
[Eaton.com/designguides](https://www.eaton.com/designguides)

Application Considerations and Definitions

Eaton's Pow-R-Line® family of distribution switchboards incorporates new design concepts that fit the ever-increasing need for applications on high short-circuit systems, while retaining maximum flexibility, safety and convenience throughout the line.

Front-Access

Front-access switchboards align at the rear, enabling them to be placed against a wall (Type Pow-R-Line Xpert™ front accessible). If the main section is deeper than others, due to physical size of the main device, the necessary offset in lineup will occur in front, and the main section will be accessible from the side as well as from the front. Eaton also offers front accessible switchboards that align at the front and rear.

Front- and Rear-Access

Front- and rear-access switchboards align at the front and the rear. Bus maintenance and cable entry and exit require rear access. There are two types of rear-accessible switchboards. Both types use the same incoming utility and/or main structures. The first type uses group-mounted feeder devices with panel construction (Type Pow-R-Line Xpert front and rear accessible). The second type uses individually compartmentalized feeder devices with load side insulated bus bar extensions (Type Pow-R-Line iX).

Individually Mounted

Larger overcurrent protective devices (OCPD) may be individually mounted. In most cases, this means that the OCPD is mounted vertically in the switchboard and is connected via bus bar. All insulated case circuit breakers, power air circuit breakers and bolted pressure contact switches are individually mounted. Molded case circuit breakers 600 A and above may be individually mounted when used as a main or as a feeder device feeding other OCPD within a section or adjacent sections.

Compartmentalized Feeder and Branch Devices

Compartmentalized molded case circuit breakers and fusible switches provide additional isolation. Individually mounted molded case circuit breakers and fusible switches through 1200 A are available in a compartmentalized, rear-access, rear-connected switchboard. See Pow-R-Line iX switchboards in this section for details.

Standard Switchboard Height

Standard Pow-R-Line switchboard height is 90.00 inches (2286.0 mm). Contact Eaton for special heights.

Group Mounting

Group-mounted circuit protective devices are an assembly of units mounted on a panelboard type chassis. Units may be molded case breakers, fusible switches, customer metering and surge protective devices.

A main molded case breaker or main fusible switch, within the sizes listed for panelboard design, can be included in the panel-mounted assembly in lieu of a separate, individually mounted unit.

Space Only for Future Devices Group-Mounted Construction

Where space only for future circuit protective devices is required, the proper space and a blank filler plate will be supplied. Connections and mounting hardware are not included.

Provision for Future Devices

Where provisions for future circuit protective devices are required, space for the device, corresponding vertical bus, device connectors and the necessary mounting hardware will be supplied.

Bus Bar System

Standard bus in the switchboards is tin-plated aluminum. Copper, silver-plated copper or tin-plated copper are also available.

Main bus and sub-main buses meet UL® and NEMA® standards for temperature rise on all Pow-R-Line switchboards. Special density rated bus is available.

Overcurrent Devices

To properly select and size overcurrent devices for use in a switchboard, the allowable temperature rise must be taken into account as to its effect on the tripping characteristics of the devices in question per UL 891.

Accordingly, the NEC® requires overcurrent devices to be rated not less than 125% of the continuous load they are protecting. To comply with this, an 80% derating factor must be used with all overcurrent devices such as molded case breakers and FDPW fusible switches unless they are tested and listed for application at 100% of the rating. All Magnum type breakers and bolted pressure switches are 100% rated.

Short-Circuit Rating

Standard bus and connectors on all switchboards are rated for use on systems capable of producing up to 65,000 A rms symmetrical short-circuit current at the incoming terminals.

Increased bus short-circuit ratings equal to that of connected switchboard devices, up to 200,000 A rms symmetrical, are available in most Pow-R-Line Xpert switchboards when approved main devices are installed. UL labeled switchboard sections are marked with their applicable short-circuit rating.

When air power circuit breakers are used as feeder devices in a switchboard, these devices may experience up to a 30-cycle (1/2 second) delay if the instantaneous setting is turned off. Eaton has qualified our low voltage switchboards when air power circuit breakers are used as feeders (and mains) to 30 cycles. This rating is not recognized under the UL 891 standard. However, Eaton has witness tested the structure bussing with a qualified National Recognized Testing Laboratory (NRTL) at 30 cycles (1/2 second) up to 100 kAIC symmetrical.

Provision for Busway Entrance and Exit

Busway connections to switchboard sections include cutout and drilling in the top of the switchboard with riser connections from the switchboard device or bus, up to the point where the bus duct enters the switchboard. No connections are furnished external to the switchboard.

In all transactions involving busway attached to switchboards, it is essential that information regarding orientation of the busway with respect to the front of the switchboard be supplied to the coordinating assembly plant.

On Pow-R-Line Xpert switchboards, a solid bus bar is used to connect the bus duct to the individually mounted main device, main or sub-main switchboard bus, or vertical main bus of panel-mounted circuit protective device panels. **Busway fed by group-mounted branch devices are cable connected.**

Aluminum riser connections are standard. Copper- or silver-plated copper is available as an option.

Transitions

Transition structures are required for connecting switchboards to the secondary of power center transformer (fluid filled), motor control centers, and for other special switchboard configurations such as "L" or "U" shaped lineups. In some applications, an extra structure complete with connections is required; in others, where switchboard depth and space permit, only the connection conductors are required. Refer to Eaton for these applications.

Auxiliary Structures

These are normally mounted adjacent to service structures or distribution structures, and used where incoming service or feeder conductors require additional space or facilities not included in the standard switchboard, such as:

1. Mounted adjacent to a top connected service structure and used as a cable pull structure where service conductors are brought in underground. Auxiliary structures are the same depth and height as the service structure, and are wide enough to accommodate the incoming cables.

2. Mounted adjacent to a service structure and used as a bus transition compartment for running riser bus from the load-side of the service structure up to top outgoing bus duct connection when distribution structures are not required. Auxiliary structures are the same depth and height as service structures.

In addition to the above applications, auxiliary structures may be mounted adjacent to a distribution structure and used as a structure for lighting panel or other device that may be cable-connected to a branch circuit device in the distribution structure. Dimensions are compatible with the arrangements required.

Switchboards Used as Service Equipment

Service equipment is the electrical equipment that constitutes the main control and means of power cutoff the electric service (normally Power Company supply) brought into the building.

Where switchboards are to be used as service equipment, certain NEC and UL requirements apply that necessitate modifications not normally supplied in switchboards.

The following is a summary of the requirements that are pertinent to the application of a switchboard for service equipment:

- A. A switchboard with main lugs only (no main disconnect) must be designed so that all circuits in the switchboard can be disconnected from the supply source by the operation of no more than six operating handles (breaker or switch).

Switchboard equipped with main disconnect devices are not subject to the above six disconnect limitation, as the entire board can be de-energized with the main disconnect device.

Ground fault protection of equipment must be provided for solidly grounded wye electrical services of more than 150 V to ground, but not exceeding 600 V phase-to-phase for each service disconnecting means rated 1000 A or more.

- B. For testing purposes, means are also required to disconnect the switchboard neutral bus from the grounded service neutral conductor (single-phase, three-wire; and three-phase, four-wire systems). To comply with this requirement, a removable link (solid bar) is provided in the switchboard neutral bus. This link is generally located near the point where the main feeders enter the switchboard or in the area of the main disconnect device where one is provided.

To further comply with NEC and UL requirements, a separate bonding strap is connected from the neutral bus to the switchboard frame. This bonding connection is located on the line side of the removable neutral link, maintaining a service ground to the switchboard frame when the test link is removed. See **Figure 21.5-1**.

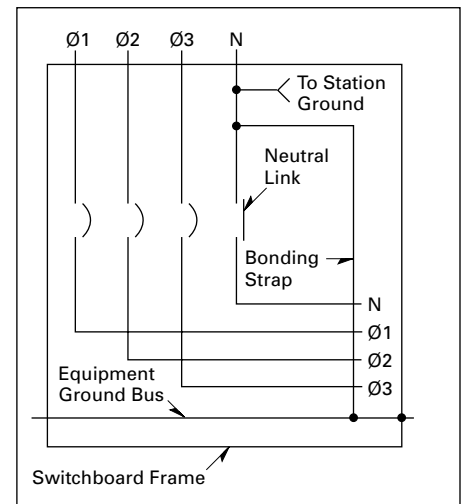

Figure 21.5-1. Neutral Link

UL labeling will clearly indicate service equipment listed switchboards.

Underwriters Laboratories Requirements and Labeling

The basic requirement for obtaining a UL label on a switchboard, is that all the component devices (breakers, switches, and so on) in the switchboard assembly are UL listed. In addition, the switchboard must comply with all applicable provisions of UL 891.

Today's modern electrical systems require that switchboards offer a wide selection of electrical devices, many of which do not fall within the scope of UL listed devices. Therefore, the conditions under which a switchboard may be labeled are limited.

Listed below are several important guidelines for consideration when a UL label is specified:

1. UL nameplates, where applicable, are supplied for each vertical structure rather than one common nameplate for the complete switchboard lineup. Where all of the component devices in the switchboard are UL listed and all applicable provisions of UL 891 are met, each of the switchboard sections may be labeled.
2. Individual vertical structures of a switchboard may be labeled where they comply with UL requirements, although other vertical structures in the same switchboard lineup may not meet the UL standards, and will not be labeled.
3. All Pow-R-Line Xpert switchboards are UL labeled when all mounted devices are UL listed.

Alternate Power Source Capabilities

Multiple solutions are available to accommodate alternate power sources available. Due to the large number of customer and system requirements, details are not provided in this guide. Eaton offers solutions that include main-main configuration and main-tie-main configurations. Automatic transfer equipment, including UL 1008 listed transfer switches and other automatic transfer schemes, are available.

Automatic Transfer Equipment

For continuity of service, automatic transfer equipment between two incoming sources may be required. This equipment transfers the load upon failure of the normal (or preferred) source to the standby (or alternate) source. Upon restoration of the normal source, the load is automatically transferred back to it. To accomplish this, electrically operated main protective devices (and bus tie devices, if required) must be employed. Additional relays also are required to detect source voltage failure and to transfer control power, when required. A manual selector switch is usually provided to select the mode of operation — automatic or manual transfer.

Seismic Qualification



Refer to Power Distribution Systems Design Guides for information on seismic qualification for this and other Eaton products.

Product Overview



Integrated Facility System Switchboards

General Description

Eaton’s Integrated Facility System™ switchboard product is a simple concept. This technology integrates standard panelboards, dry-type distribution transformers, contactors and other electrical equipment into free-standing, front-access switchboards.

Integrated Facility System Switchboard Benefits

- Space savings up to 50% or more
- Factory wired and pre-tested
- Assembled and ready to install
- Significantly reduces installation time and materials
- Significantly reduces materials associated with panel installation
- Frees up additional space at no charge to the owner
- Installed cost is typically less than with traditional products
- Sustainability and LEED® compliant

Available Options

- Automatic transfer switches
- UPS (Uninterrupted Power Supplies)
- SPD (surge protective devices)
- HVAC control
- Lighting control
- Power factor correction
- Metering
- Generator Quick Connect
- Customer metering
- Lighting power reduction products

Standards

- Meets NEMA Standard PB-2 and UL 891
- Used with Type 1 Pow-R-Line X switchboard sections
- Select main, branch feeder, customer and utility metering from Devices section
- Factory wired panelboards and dry-type distribution transformers meet NEMA Standard PB-2, UL 891 and the National Electrical Code

Integrated Facility System

Switchboard Sections and Selection

- From the following pages select the appropriate section “Type”
- Select from panelboards, blank steel backpans and dry-type distribution transformers by “cell”
- Layout IFS sections near standard distribution sections
- Indicate on drawings and one-line diagrams the connections from feeder devices to the appropriate cell

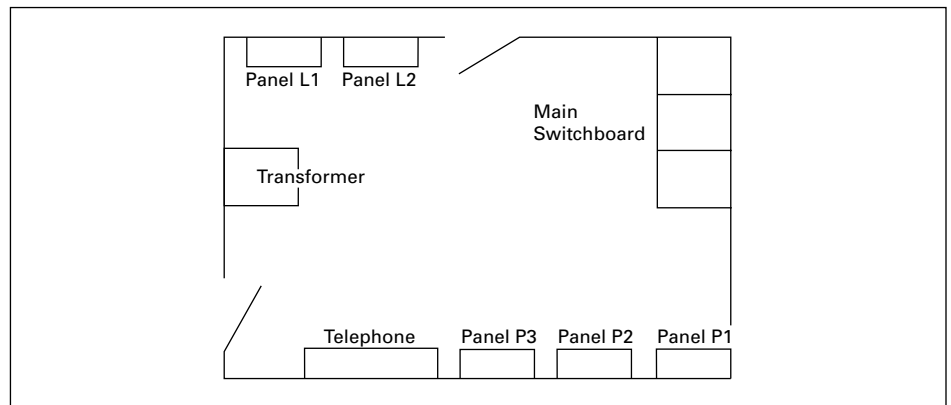

Figure 21.5-2. Traditional Electrical Room—Plan View

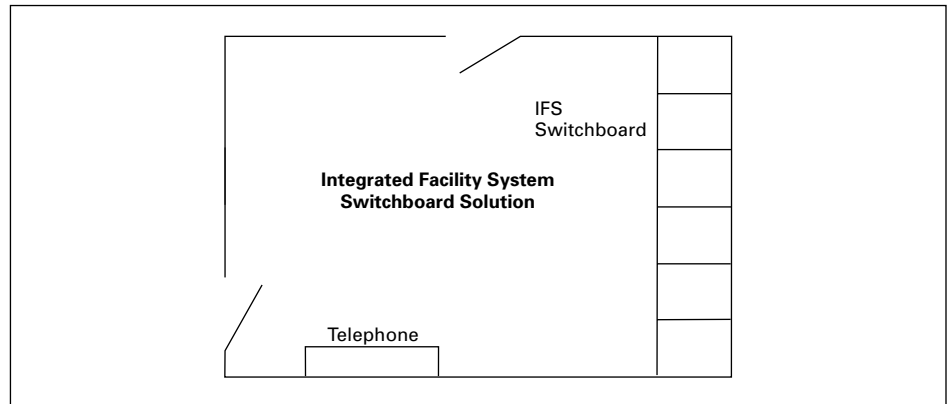

Figure 21.5-3. IFS Electrical Room—Plan View

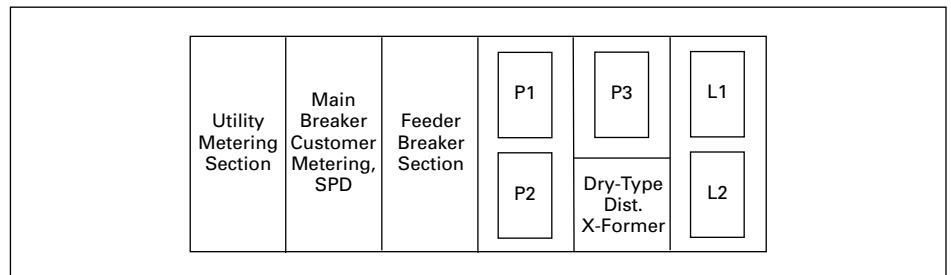

Figure 21.5-4. Optimized IFS Layout—Front View

Circuit Breakers and Fusible Switches—Chassis Mounting

Table 21.5-1. Molded Case Circuit Breakers

Circuit Breaker Type	Continuous Ampere Rating at 40 °C	Number of Poles	Voltage		Trip Type ①	UL Listed Interrupting Ratings rms Symmetrical Amperes									
			AC	DC		AC Ratings Volts						DC Ratings Volts ②			
						120	120/240	240	277	480	600	125	250	125/250	600
PDD2xF	100–225	2, 3	240	125	N.I.T.	—	—	22	—	—	—	10	—	—	—
PDD2xG	100–225	2, 3	240	125	N.I.T.	—	—	65	—	—	—	10	—	—	—
PDD2xM	100–225	2, 3	240	125	N.I.T.	—	—	100	—	—	—	10	—	—	—
PDD2xP	100–225	2, 3	240	125	N.I.T.	—	—	200	—	—	—	10	—	—	—
PDG2xF	15–100	1	277	125	N.I.T.	—	—	—	14	—	—	10	—	—	—
PDG2xF	15–100	2, 3	480	250	N.I.T.	—	—	18	—	14	—	—	10	—	—
HFDCC ③	15–150	2, 3	—	600	N.I.T.	—	—	—	—	—	—	42	42	—	35
PDG2xG	15–225	1	277	125	N.I.T.	—	—	—	35	—	—	10	—	—	—
PDG2xG	15–225	2, 3	600	250	N.I.T.	—	—	65	—	35	18	—	10	—	—
PDG2xG	15–225	4	600	250	N.I.T.	—	—	65	—	35	18	—	10	—	—
PDG2xM	15–225	1	277	125	N.I.T.	—	—	—	65	—	—	10	—	—	—
PDG2xM	15–225	2, 3	600	250	N.I.T.	—	—	100	—	65	25	—	22	—	—
PDG2xM	15–225	4	600	250	N.I.T.	—	—	100	—	65	25	—	22	—	—
PDG2xP	15–225	2, 3	600	250	N.I.T.	—	—	200	—	100	35	—	22	—	—
PDG2xP	15–225	4	600	250	N.I.T.	—	—	200	—	100	35	—	22	—	—
HJDDC ③	70–250	2, 3	—	600	I.T.	—	—	—	—	—	—	42	42	—	35
JGE ④	70–250	2, 3	600	250	I.T.	—	—	65	—	25	18	—	—	10	—
JGS ④	70–250	2, 3	600	250	I.T.	—	—	65	—	35	25	—	—	—	—
JGH ④	70–250	2, 3	600	250	I.T.	—	—	100	—	65	35	—	—	—	—
JGC ④	70–250	2, 3	600	250	I.T.	—	—	200	—	100	50	—	—	—	—
PDG3xG ⑤	250–400	2, 3	240	250	N.I.T.	—	—	65	—	—	—	—	10	—	—
PDG3xG ⑤	70–400	2, 3	600	250	I.T.	—	—	65	—	35	25	—	10	—	—
PDF3xG ⑤⑥	70–400	3	600	250	I.T.	—	—	65	—	35	25	—	10	—	—
PDG3xM ⑤	70–400	2, 3	600	250	I.T.	—	—	100	—	65	35	—	22	—	—
PDF3xM ⑤	70–400	3	600	250	I.T.	—	—	100	—	65	35	—	22	—	—
PDD3xP	70–400	2, 3	600	250	I.T.	—	—	200	—	100	50	—	22	—	—
HKDDC ③	100–400	2, 3	—	600	I.T.	—	—	—	—	—	—	42	42	—	35
LHH ⑦	125–400	2, 3	600	250	I.T.	—	—	100	—	65	35	—	42	—	—
NHH	150–350	3	600	—	—	—	—	100	—	65	35	—	—	—	—
LGE ④⑦	300–600	2, 3	600	250	I.T.	—	—	65	—	35	25	10	22	—	—
LGH ④⑦	300–600	2, 3	600	250	I.T.	—	—	100	—	65	35	10	22	—	—
LGC ④⑦	250–600	2, 3	600	250	I.T.	—	—	200	—	100	50	—	42	—	—
PDG3xG ⑤⑧	300–600	2, 3	600	250	I.T.	—	—	65	—	35	25	10	22	—	—
PDG3xM ⑤⑧	300–600	2, 3	600	250	I.T.	—	—	100	—	65	35	10	22	—	—
PDG3xP ⑤⑦⑧	250–600	2, 3	600	250	I.T.	—	—	200	—	100	50	—	42	—	—
PDG4xG ⑦	400–800	2, 3	600	250	N.I.T.	—	—	65	—	50	25	—	22	—	—
PDF4xG ④⑦	400–800	3	600	—	N.I.T.	—	—	65	—	50	25	—	22	—	—
PDG4xM ⑦	400–800	2, 3	600	—	N.I.T.	—	—	100	—	65	35	—	25	—	—
PDF4xM ④⑦	400–800	3	600	—	N.I.T.	—	—	100	—	65	35	—	25	—	—
HMDLDC ③	300–800	2, 3	—	600	I.T.	—	—	—	—	—	—	42	42	—	—
PDG5xM	600–1200	2, 3	600	—	N.I.T.	—	—	100	—	65	35	—	—	—	—
PDG5xP	600–1200	2, 3	600	—	N.I.T.	—	—	200	—	100	50	—	—	—	—
NGH ④	600–1200	2, 3	600	—	N.I.T.	—	—	100	—	65	35	—	—	—	—
NGC ④	600–1200	2, 3	600	—	N.I.T.	—	—	200	—	100	50	—	—	—	—
CNGC ③	600–1200	3	600	—	N.I.T.	—	—	200	—	100	50	—	—	—	—
NBDC ③	700–1200	2, 3	—	600	I.T.	—	—	—	—	—	—	42	42	—	50
RG 1600	800–1600	3	600	—	N.I.T.	—	—	125	—	65	50	—	—	—	—
CRG 1600	800–1600	3	600	—	N.I.T.	—	—	125	—	65	50	—	—	—	—
RG 2000	1000–2000	3	600	—	N.I.T.	—	—	125	—	65	50	—	—	—	—
PDG6xP 1600	700–1600	3	600	—	N.I.T.	—	—	200	—	100	65	—	—	—	—
PDG6xP 2000	1000–2000	3	600	—	N.I.T.	—	—	200	—	100	65	—	—	—	—
PDG6xP 2500	1000–2500	3	600	—	N.I.T.	—	—	200	—	100	65	—	—	—	—
PDG6xP ③⑨	1600–2000	2, 3	—	600	I.T.	—	—	—	—	—	—	42	65	—	65

① N.I.T. is non-interchangeable trip unit. I.T. is interchangeable trip unit.
 ② Two-pole circuit breaker, or two poles of three-pole circuit breaker at 250 Vdc.
 ③ For use on DC systems only.
 ④ For use with drawout feeder device only.
 ⑤ The 400 A frame must use trip units of ratings 100–400, while the 600 A frame must use trip units of ratings 500, 600 or designated by H, such as H250. The H as the leading character of the ampacity indicates a high instantaneous version of the breaker for coordination purposes. H ratings must use 600 A frame.
 ⑥ 100% rated.
 ⑦ Not available in Pow-R-Line iX switchboards.
 ⑧ Available in bolt-on fixed mount or drawout feeder device.
 ⑨ Individually, vertically mounted.

Table 21.5-2. Power Defense SB Insulated Case Circuit Breaker Interrupting Ratings ①

Circuit Breaker Type	Frame Amperes	Trip Unit Current Sensor and Rating Plug Ranges	Ratings rms Symmetrical Amperes (kAIC)		
			Interrupting Ratings		
			208/240 Vac	480 Vac	600 Vac
SPS-608	800	200-800	65	65	65
SPS-C08	800	200-800	100	100	85
SPS-612	1200	200-1200	65	65	65
SPS-C12	1200	200-1200	100	100	85
SPS-616	1600	200-1600	65	65	65
SPS-C16	1600	200-1600	100	100	85
SPS-620	2000	200-2000	65	65	65
SPS-C20	2000	200-2000	100	100	85
SPS-625	2500	200-2500	65	65	65
SPS-C25	2500	200-2500	100	100	85
SPS-630	3000	200-3000	65	65	65
SPS-C30	3000	200-3000	100	100	85
SPS-840	4000	2000-4000	65	65	65
SPS-C40	4000	2000-4000	100	100	85
SPS-850	5000	2500-5000	65	65	65
SPS-C50	5000	2500-5000	100	100	85

① Fixed internal instantaneous trip set at approximately $18 \times I_n$ symmetrical.

Table 21.5-3. Series NRX RF Insulated Case Circuit Breaker Interrupting Ratings

Circuit Breaker Type	Frame Amperes	Trip Unit Current Sensor Ranges	Ratings rms Symmetrical Amperes (kAIC)	
			Interrupting Ratings	
			208/240 Vac	480 Vac
NRX-RF PXR 20/25	800	800	100	65
NRX-RF PXR 20/25	1200	800-1200	100	65
NRX-RF PXR 20/25	1600	800-1600	100	65
NRX-RF PXR 20/25	2000	800-2000	100	65
NRX-RF PXR 20/25	2500	800-2500	100	65
NRX-RF PXR 20/25	3000	800-3000	100	65
NRX-NF PXR 20/25	800	200-800	85	65
NRX-NF PXR 20/25	1200	200-1200	85	65

Table 21.5-4. Magnum PXR Power Breaker Interrupting Ratings

Circuit Breaker Type	Frame Amperes	Ratings rms Symmetrical Amperes (kAIC)					
		Interrupting Ratings			Short-Time Rating ②		
		208/240 V	480 V	600 V	208/240 V	480 V	600 V
MPS-408	800	42	42	42	42	42	42
MPS-608	800	65	65	65	65	65	65
MPS-808	800	85	85	85	85	85	85
MPS-C08	800	100	100	100	85	85	85
MPS-616	1600	65	65	65	65	65	65
MPS-816	1600	85	85	85	85	85	85
MPS-C16	1600	100	100	100	85	85	85
MPS-620	2000	65	65	65	65	65	65
MPS-820	2000	85	85	85	85	85	85
MPS-C20	2000	100	100	100	85	85	85
MPS-632	3000	65	65	65	65	65	65
MPS-832	3000	85	85	85	85	85	85
MPS-C32	3000	100	100	100	85	85	85
MPS-840	4000	130	85	85	85	85	85
MPS-C40	4000	130	100	100	100	100	100
MPS-850	4000	130	85	85	85	85	85
MPS-C50	5000	130	100	100	100	100	100

② Also ratings without instantaneous trip.

Table 21.5-5. Current Limit-R Current Limiting Circuit Breakers—Non-Fused Type

Circuit Breaker Type	Cont. Ampere Rating at 40 °C	No. of Poles	Voltage		Trip Type ①	Federal Spec. W-C-375b	UL Listed Interrupting Ratings rms Symmetrical Amperes								
			AC	DC			AC Ratings Volts						DC ②		
							120	120/240	240	277	480	600	125	250	125/250
FCL	15–100	2, 3	480	—	N.I.T.	③	—	—	200,000	—	150,000	—	—	—	—

① N.I.T. is non-interchangeable trip unit and I.T. is interchangeable trip unit.

② Two-pole circuit breaker, or two poles of three-pole circuit breaker at 250 Vdc.

③ Not defined in W-C-375b.

Table 21.5-6. TRI-PAC Current Limiting Circuit Breakers—Fused Type

Circuit Breaker Type	Cont. Ampere Rating at 40 °C	No. of Poles	Voltage		Trip Type ④	Federal Spec. W-C-375b	UL Listed Interrupting Ratings rms Symmetrical Amperes								
			AC	DC			AC Ratings Volts						DC ⑤		
							120	120/240	240	277	480	600	125	250	125/250
FB	15–100	2, 3	600	250	N.I.T.	16a, 16b, 17a, 26a	—	—	200,000	—	200,000	200,000	—	—	100,000
LA	70–400	2, 3	600	250	I.T.	16a, 16b, 17a, 26a	—	—	200,000	—	200,000	200,000	—	—	100,000
NB	300–800	2, 3	600	250	I.T.	16b, 17a, 26a	—	—	200,000	—	200,000	200,000	—	—	100,000
PB	600–1600	2, 3	600	250	I.T.	17a, 26a	—	—	200,000	—	200,000	200,000	—	—	100,000

④ N.I.T. is non-interchangeable trip unit and I.T. is interchangeable trip unit.

⑤ Two-pole circuit breaker, or two poles of three-pole circuit breaker at 250 Vdc.

Table 21.5-7. Electrical Characteristics of Fusible Switches

Device Type	System Voltage	Ampere Rating	Interrupting Capacities kA Symmetrical Amperes
Fusible switch	240 or 600	30–600 300–1200 30–600 800, 1200	200 kAIC with Class R Fuses 200 kAIC with Class T Fuses 200 kAIC with Class R and J Fuses 200 kAIC with Class L Fuses
Bolted pressure switch	240 or 480	800, 1200, 1600 2000, 2500, 3000, 4000, 5000, 6000 ⑥	200 kAIC with Class L Fuses 200 kAIC with Class L Fuses 200 kAIC with Class L Fuses

⑥ 5000 A and 6000 A bolted pressure contact switch is not UL listed.

Table 21.5-8. Standard Switchboard Terminals, Standard Main Breaker, Branch Breaker, Main Switch or Branch Switch Terminals

Breaker Type	Ampere Rating	Wire Size Ranges
PDD2xF, PDD2xG, PDD2xM, PDD2xP	100–225	# 4–#4/0 or # 6–300 kcmil
PDG2xF, PDG2xG, PDG2xM PDG2xP	15–100 125–225	#14–#1/0 # 4–#4/0 or #6–300 kcmil
FCL	15–100	#14–#1/0
JGS, JGH, JGC	70–250	# 4–350 kcmil
PDD3xG	250–350 400	(1) 250–500 kcmil (2) 3/0–250 kcmil or (1) 3/0–500 kcmil
PDG3xG ①, PDG3xM ①, PDG3xP ①, PDF3xG ②, PDF3xM ②	100–225 250–350 400	(1) #3–350 kcmil (1) 250–500 kcmil (2) 3/0–250 kcmil (1) 3/0–500 kcmil
PDG3xG ①, PDG3xM ①, LD ②, LHH, PDG3xP ①, NHH	300–500 600 150–350	(2) 250–350 kcmil (2) 400–500 kcmil (1) #2–600 kcmil
PDG4xG, PDF4xG ①②, PDG4xM, PDF4xM	400–600 700–800	(2) #1–500 kcmil (3) 3/0–400 kcmil (2) 500–750 kcmil
PDG5xM, PDG5xP, PDG6xM ①②, PDG5xP ①②	600–1000 1200	(3) 3/0–400 kcmil (4) 4/0–500 kcmil
FB-P	15–100	#14–1/0
LA-P	70–225 250–400	(1) #6–350 kcmil (1) #4–250 kcmil and (1) 3/0–600 kcmil
NB-P	350–700 800	(2) #1–500 kcmil (3) 3/0–400 kcmil

① The 400 A frame must use trip units of ratings 100–400, while the 600 A frame must use trip units of ratings 500, 600 or designated by H, such as H250. The H as the leading character of the ampacity indicates a high instantaneous version of the breaker for coordination purposes. H ratings must use 600 A frame.

② 100% rated breaker.

Note: All terminal sizes are based on wire ampacities corresponding to those shown in NEC Table 310.16 under the 75 °C insulation columns (75 °C wire). The use of smaller size (in circular mills), regardless of insulation temperature rating is not permitted without voiding UL labels on devices and equipment.

Note: For other terminals available on some ratings of molded case circuit breakers and fusible switches, refer to Molded Case Circuit Breakers & Enclosures Design Guides.

Cable Ranges for Standard Secondary Device Terminals

Wire and cable terminals supplied on switchboard mounted devices for making up incoming or outgoing cable connections are of the mechanical screw clamp pressure type. All standard terminals are suitable for use with either aluminum or copper cable except as noted in the table. Panel mounted devices use the standard terminal provided with that device.

Table 21.5-9. Fusible Switches

Ampere Rating	Wire Size Ranges
30, 60, 100 200	#14–1/0 #4–300 kcmil
400	250–750 kcmil or (2) 3/0–250 kcmil
600	(2) #4–600 kcmil or (4) 3/0–250 kcmil
800	(3) 250–750 kcmil or (6) 3/0–250 kcmil
1200	(4) 250–750 kcmil or (8) 3/0–250 kcmil

Table 21.5-10. Standard Mechanical Incoming Terminal Ranges for Main Lugs Only and Main Devices Including Circuit Breakers and Fusible Devices

Ampere Rating	Cable Range
400 600 800	(2) #2–500 kcmil (2) #2–500 kcmil (3) #2–500 kcmil
1000 1200 1600	(4) #2–500 kcmil (4) #2–500 kcmil (5) #2–500 kcmil
2000 2500 3000	(6) #2–500 kcmil (7) #2–500 kcmil (10) #2–500 kcmil

Table 21.5-11. Range Taking Compression Main Terminals ③

Main Ampere Rating	Number of Conductors and Wire Range Per Phase	
	Aluminum Conductors	Copper Conductors
1200	(4) 500–750 kcmil	(3) 500–750 kcmil
1600	(5) 500–750 kcmil	(4) 500–750 kcmil
2000	(6) 500–750 kcmil	(4) 500–750 kcmil
2500	(7) 500–750 kcmil	(6) 500–750 kcmil
3000	(8) 500–750 kcmil	(7) 500–750 kcmil
4000	(11) 500–750 kcmil	(9) 500–750 kcmil
5000	(13) 500–750 kcmil	(11) 500–750 kcmil

③ Compression terminations will take a range of conductors and include 500, 600, 700 and 750 kcmil.

Power Xpert Release Trip Unit for Insulated Case Circuit Breakers



Power Xpert Release Trip Unit

Description

Eaton's Power Xpert Release (PXR) trip units are programmable communicating microprocessor-based low-voltage electronic trip unit systems for Eaton insulated case circuit breakers. PXR trip units are available in two models: PXR 20 and PXR 25.

The PXR electronic trip units provide an enhanced and easy-to-use interface that enables end users and maintenance engineers to more easily change set points, test and configure circuit breakers, and review energy and power information. Also, the Power Xpert Protection Manager software provides the capability of secondary injection tests and reports on-demand without the need of expensive test kits.

Standards and Certifications

The PXR trip units are listed by Underwriters Laboratories (UL) and Canadian Standards Association (CSA®) for use in Series NRX™ NF and Series NRX RF circuit breakers. All PXR units have also passed the IEC 60947-2 test program that includes EMC testing. All trip units meet the low-voltage and EMC directives and carry the CE mark.

Features

Table 21.5-12. Power Xpert Features

Trip Unit	PXR 20	PXR 25
Diagnostics and Indication Features		
Trip log	10 trip events 200 summary Additional storage available via CAM module	
Alarm log	10 alarm events—through COM	
Waveform capture	One waveform event captured in ETU	
Display	LCD dot matrix	
LEDs	ETU status Long trip Short trip	Instantaneous trip Ground trip Arcflash Reduction Maintenance System™ status
Power for cause of trip LEDs	Control power or battery	
Battery indication	Display (no PTT)	
Maintenance/wellness health and diagnostics	ETU temp. and max. Trip count Ops count / last date	Operating (run) time Health bar (algorithm)

PXR Metering, Communications and Other Features

Metering—current	Yes Phase, Neutral, Ground, min., max., demand, peak	
Metering—voltage	No	Yes L-L, L-N, avg. min., max., Frequency, min., max.
Metering—power	No	Yes kW, kVA, kvar Demand-kW, kVA, kvar Peak Demands
Metering—energy	No	Yes kWh-fwd, rev, net, tot kvarh-lead, lag, net, tot
Metering—PF apparent	No	Yes min., max.
Communications	Modbus RTU optional CAM modules optional	Modbus RTU native CAM modules optional
Testing method	PC via USB port Internal Secondary injection test circuit	
Relay outputs—alarms or trips	3	
QR code—support information	Yes	
Password—setting menu and test	Yes	
RoHS	Yes	

Protection Features

Ordering options	LSI, LSIG/A
Number of sensors	1 sensor—NF 1 sensor—RF
Sensor (rating) plug (I_n)	No plug Programmable I_n (21)
Slopes	I_t , I^2t , I^2t IEEE—MI, VI, EI
System frequency	50 / 60 Hz
Long delay pickup (I_L)	$0.4-1.0 \times (I_n)(10)$
Long delay time I^2t at $6 \times (I_L)$	$0.5-24 \text{ s} (10)$
Long delay thermal memory	Yes—Program disable
Short delay pickup	$1.5-10 \times (I_n)(10)$
Short delay time I^2t at $8 \times (I_L)$	0.1, 0.3, 0.4, 0.5 s
Short delay time flat	0.0, 0.1, 0.2, 0.3, 0.4, 0.5 s
Instantaneous pickup	$2-15 \times (I_n)(10)$
Ground (earth) fault pickup	Trip: $0.2-1.0 \times (I_n)(5)$ Alarm: $0.2-1.0 \times (I_n)(4)$ Off
Ground (earth) fault time I^2t at $0.625 \times (I_n)$	0.1, 0.2, 0.3, 0.4, 0.5 s
Ground (earth) fault time flat	0.1, 0.2, 0.3, 0.4, 0.5 s
ZSI, short delay and ground	Programmable Display indication
Neutral protection	Yes Off, 60, 100%
Arcflash Reduction Maintenance System—arc flash—mode/settings	Optional—on or off/remote 5 settings ($\times I_n$)

Power Xpert Release Trip Unit for Molded Case Circuit Breakers

Description

Eaton's Power Xpert Release (PXR) trip units are programmable communicating microprocessor-based low-voltage electronic trip unit systems for Eaton molded case circuit breakers. PXR trip units are available in four models: PXR 10, PXR 20, PXR 20D and PXR 25. For more information, visit www.eaton.com/mccb.

Standards and Certifications

The PXR trip units are listed by Underwriters Laboratories (UL) and Canadian Standards Association (CSA) for use in Frame PD-2, PD-3, PD-4, PD-5, and PD-6 molded case circuit breakers. All PXR units have also passed the IEC 60947-2 test program that includes EMC testing. All trip units meet the low-voltage and EMC directives and carry the CE mark.

Features

The PXR electronic trip units provide an enhanced and easy-to-use interface that enables end users and maintenance engineers to more easily change set points, test and configure circuit breakers, and review energy and power information. Also, the Power Xpert Protection Manager software provides the capability of secondary injection tests and reports on-demand without the need of expensive test kits.

Advanced features include:

- Industry-first breaker health algorithms that provides real-time monitoring and communication of breaker condition
- Cause of trip LED indication and trip event data storage
- Zone selective interlocking (ZSI) verification and testing indication
- Adjustable Arcflash Reduction Maintenance System settings
- LCD display with programmable settings



Arcflash Reduction Maintenance System

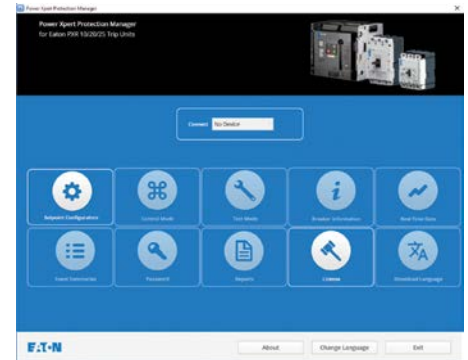

Power Xpert Protection Manager (PXPM) Software

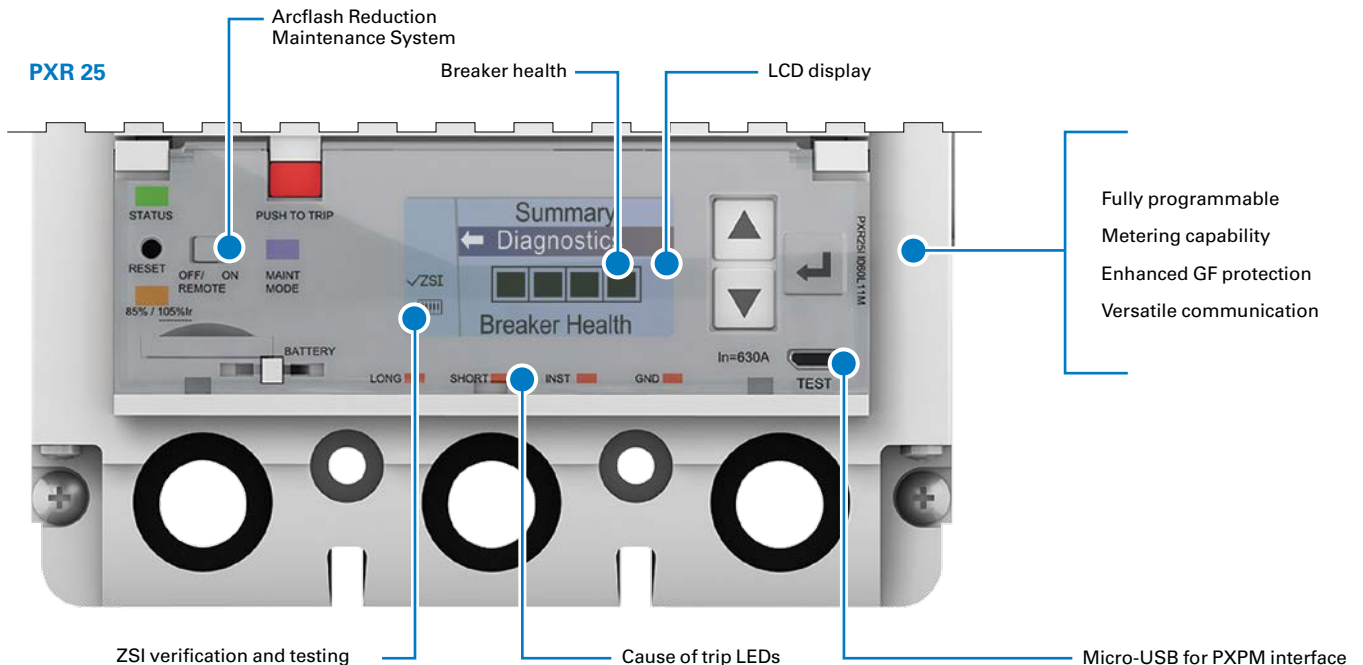

PXR 25 Trip Unit Features

Table 21.5-13. Power Xpert Release (PXR) Features

Features	PXR 10	PXR 20	PXR 25
Protection types	LSI	LSI/LSIG	LSI/LSIG
Status indication	Standard	Standard	Standard
USB secondary injection testing	Standard	Standard	Standard
Programmable by USB port (PXPM)	Standard	Standard	Standard
Independent instantaneous adjustment	Standard	Standard	Standard
Adjustable L, S, I, G pickup and time		Standard	Standard
Cause of trip indication	Available through USB port (PXPM)	Standard	Standard
Load alarm indication with 2 levels		Standard	Standard
Programmable load alarm levels			Standard
Ground fault protection and alarm		Optional	Optional
Arcflash Reduction Maintenance System Available PD3, PD4, PD5, PD6		Optional	Optional
Zone selective interlocking (ZSI) with indication		Optional	Optional
Programmable relays		Optional	Standard
Modbus RTU communication		Optional	Standard
CAM module communication		Optional	Optional
Rotatable LCD display			Standard
Breaker health and diagnostic monitoring		Available through USB port (PXPM)	Standard
Voltage metering accurate to 0.5%			Standard
Power and energy metering accurate to 1%			Standard

Metering and Monitoring Devices



Power Xpert Meter 1000



Power Xpert Meter 2000



Power Xpert Meter 3000

Power Xpert Meter 1000

The Power Xpert Meter 1000 series power and energy meters monitor the most critical aspects of an electrical distribution system. This premier metering instrument uses the latest in advanced technology to make it simple to use, powerful, scalable and highly flexible.

The Power Xpert Meter 1000 (PXM1000), 1100 (PXM1100), 1200 (PXM1200) and 1300 (PXM1300) deliver a cost-effective solution for energy and sub-metering applications. These three-phase meters provide high accuracy and advanced features in the standard 4-inch form factor and can be expanded with multiple modular I/O options.

Meter features include:

- Utility billing accuracy that will help meet stringent customer specifications
- Ease of use in multiple applications
- Rogowski coils allow for ease of use in retrofit applications
- Multiple protocols including Modbus TCP and BACnet/IP and with available HTTP push, allowing data to be sent to the cloud to help meet energy code data storage requirements

Power Xpert Meter 2000

Power Xpert 2250 Meter

This meter provides all the core functions for monitoring power consumption and power quality, Ethernet connectivity and onboard gateway card limits. This unit uses D/A technology to sample circuits at 400 samples per cycle for extremely accurate measurement of power factor and energy consumption. In addition, the meter has 256 MB for logging meter data.

Power Xpert 2260 Meter

This meter adds the ability to monitor total harmonic distortion and the ability to set onboard meter limits. The meter also will illuminate LEDs on the faceplate, indicating that a limit has been exceeded and provides 512 MB for data logging.

Power Xpert 2270 Meter

This meter adds the ability to monitor individual harmonics and visualize waveforms on your desktop using the embedded web server and raises the storage to 768 MB for data logging.

Meter features include:

- Fully understand your facility's power quality
- Detailed event information; pinpoint the root causes of problems—or prevent them from occurring
- Measure, trend and analyze power via information through onboard web and comma separated values (CSV) exporting capabilities
- Up to 768 MB of storage; typically 15 years of storage capability depending on the meter model and frequency of events
- Local or remote configuration

Power Xpert Meter 3000

The Power Xpert Meter 3000 (PXM3000) provides an extensive array of data, including power quality, energy and demand readings so you can manage energy utilization to help reduce peak demand charges and power factor penalties, and to identify excessive energy consumption.

Utilizing both a premier web interface with cloud storage and onboard data storage up to 4 GB, the PXM3000 allows you to keep your data at your fingertips to help reduce your overall energy usage and better manage your energy costs.

Meter features include:

- Rich web interface
- Multiple protocols including Modbus RTU/TCP and BACnet/IP
- Onboard historical data charts
- Onboard waveform display
- Optional digital/analog inputs and outputs
- Storage of up to three custom data logs

Metering and Monitoring Devices, Continued



Power Xpert Meter 4000/6000/8000

Power Xpert Meter 4000/6000/8000

The Power Xpert Meter 4000/6000/8000 series is an internet-enabled (including a built-in web server) power quality and energy meter with comprehensive power and energy measurement, and integrated quality analysis.

These meters allow you to use a standard web browser to surf the meter and visualize a waveform and analyze trends.

Meter features include:

- Accurate detection of fast transients
- Early warning of impending problems
- At-a-glance view of power quality
- Reduces power monitoring cost
- Supports continuous, non-disruptive monitoring
- Accessible via the ethernet
- Uses industry-standard communication protocols



Power Xpert Multi-Point Meter

Power Xpert Multi-Point Meter

Eaton Power Xpert Multi-Point meter (PXMP) helps facility managers track and accurately allocate energy usage among tenants or departments in office buildings, shopping malls, industrial sites, universities, campuses and apartment and condominium complexes. Power Xpert Multi-Point Meters monitor, quantify and help benchmark energy usage.

Meter features include:

- Meets rigid ANSI C12.20 and IEC 62053-22 accuracy specifications for revenue meters
- Quick connect terminals for current sensors, Modbus communication and bus voltages
- Monitors power and energy for up to 60 current sensors; scalable from 6 to 60 circuits
- 256 MB of standard memory for up to two years of 15-minute interval data
- Extensive LEDs for verification of sensor connections, communication status and equipment status
- Automatically detects rating of each current sensor; current sensors are self-protecting in the event of an open circuit condition under load for added safety and reliability



Power Xpert Gateway

Power Xpert Gateway

Eaton's Power Xpert Gateway (PXG) bridges the IT and facilities management worlds by bringing disparate panelboards, switchboards and other power equipment onto the network. The PXG takes the complexity out of connecting power equipment to the network. The web-enabled PXG is an out-of-the-box device that can support up to 96 devices, translate most industrial communication protocols, and offer user-selectable events and real-time trending. It also features e-mail notification of events, waveform capture and data/event logging—all with no special software. Adding basic meters or the utility's meter, the PXG assists in tracking energy usage. The PXG recognizes the interdependence of IT systems and power systems, and delivers what organizations need to bring these worlds together for seamless, end-to-end system reliability.

The PXG consolidates data available from breakers, meters, motor controllers and protective relays, and presents the information in a variety of ways (a web browser being the most widely used method). The PXG is a stand-alone solution. As needs change and grow, the PXG can be integrated through Power Xpert Software into a broader solution that encompasses other intelligent hardware and can integrate with third-party network management systems (NMS) or building management systems (BMS) for system-wide monitoring and reporting of power and IT.

Metering and Monitoring Devices, Continued



Power Xpert Branch Circuit Monitor

Power Xpert Branch Circuit Monitor

Eaton's Power Xpert Branch Circuit Monitor (PXBCM) provides remote access to live energy readings and facilitates data integration for data center intensive industries, facilities working to optimize server capacity and companies with a critical need to maintain uptime. By combining monitoring capabilities down to the plug level with overload alerts, which indicate when circuits are close to exceeding thresholds, the PXBCM helps minimize or prevent downtime.

- ANSI C12.20 0.5% revenue accuracy for panelboard applications
- Satisfies energy code requirements to meter energy by branch circuit and report energy consumption by load group
- Modular form factor supports either pre-mounted CTs (PXBCM-MMS) or loose CTs (PXBCM-MME) and makes it easy to scale for 18-, 30-, 42- and 84-circuit panelboard applications



Power Distribution Monitoring and Control

Power Distribution Monitoring and Control

Power Distribution Monitoring and Control helps keep your critical facilities up and running by enabling interaction with low-voltage panelboards and switchboards through intelligent component control, communications and monitoring. Use of Power Distribution Monitoring and Control may simplify installation and maintenance efforts while also reducing exposure to arc flash. It also provides access to aggregate device data from electronic meters and Eaton's Power Xpert Release (PXR) trip units installed in our globally rated, Power Defense molded case circuit breakers (MCCBs).

For information on other available power meters, visit [Eaton.com/meters](https://www.eaton.com/meters)

Surge Protective Devices



Integrated Surge Protective Devices

Integrated SPDs

Eaton integrates our industry-leading SPD Series surge protective devices into panelboard and switchboard assemblies. Lead length is kept to a minimum to maximize SPD performance. Integrated SPD units are UL listed and labeled to UL 1449 3rd Edition.

Key features include:

- Thermally protected metal oxide varistor (MOV) technology
- 20 kA nominal discharge current (I_n) rating (maximum rating assigned by UL)
- 50 through 400 kA surge current capacity ratings
- Three feature package options (basic, standard, and standard with surge counter)
- 200 kA short-circuit current rating (SCCR)
- 10-year warranty

The breadth of the SPD Series' features, options and configurations ensures that the correct unit is available for all electrical applications, including service entrances, distribution switchboards, panelboards and point-of-use applications.

For complete SPD product description, application and ratings, visit www.eaton.com/spd.

Table 21.5-14. Side-by-Side Comparison of the SPD Series' Available Feature Packages

Feature package comparison	Basic	Standard	Standard with Surge Counter	Power Xpert SPD
Surge protection using thermally protected MOV technology	■	■	■	■
Dual-colored protection status indicators for each phase	■	■	■	■
Dual-colored protection status indicators for the neutral-ground protection mode ①	■	■	■	
Tri-colored protection status indicators for each phase and the neutral-ground protection mode ①				■
Audible alarm with silence button		■	■	■
Form C relay contact		■	■	■
EMI/RFI filtering, providing up to 50 dB of noise attenuation from 10 kHz to 100 MHz		■	■	■
Surge counter with reset button			■	■
Percentage protection remaining status				■
RJ45 Ethernet port for LAN connection, Modbus TCP/IP or BACnet/IP				■
UI webpage and programmable settings				■
Time-and-date stamped surge log and surge categorization				■

① Neutral-ground protection mode available in applicable voltage configurations only.

Distribution Section Devices



Pow-R-Line 1X, 2X and 3X Panelboards

Pow-R-Line 1X, 2X and 3X Panelboards

Eaton is the industry leader in panelboard products, providing features, ratings and performance that consistently meet the needs of specifiers, consultants and contractors.

Key features include:

- Robust design using Eaton circuit breakers
- Increased ratings (with series rated main circuit breakers) provide higher short-circuit ratings
- Pow-R-Line 3X can accommodate branch breakers dual-mounted through 150 A and single-mounted through 225 A
- Lock and door opening mechanism includes a positive slide catch and right- or left-hand installation
- Surface or flush trims
- UL tested and listed. Meets NEC® and NEMA® standards

For more information, consult the Pow-R-Line 1X, 2X and 3X Design Guide, or visit www.eaton.com/panelboards.



Pow-R-Line 3X EV Charging Panelboards

Pow-R-Line 3X EV Charging Panelboards

Eaton offers EV charging capabilities within an easy-to-install panelboard. The Pow-R-Line Xpert panelboard with Green Motion EV smart breaker chargers provides fast AC charging at 7.7 kW, revenue-grade metering, remote access capabilities and significant space savings.

Key features include:

- 240 Vac maximum voltage class
- 100–800 A rating
- 10 kAIC fully rated
- Fast AC Level 2 charging
- Up to 18 EV smart breaker chargers per panelboard
- Options available for EV charging accessories

For more information, visit www.eaton.com/panelboards.



Pow-R-Command Lighting Control

Pow-R-Command Lighting Control

Pow-R-Command lighting control and plug load control panelboards integrate branch circuit protection and control (switching and dimming) in a single panelboard enclosure. Integrated architecture simplifies system design, reduces installation labor and saves 50% wall-mounting space. Designed to meet ASHRAE and IECC code requirements for networked lighting controls systems. Standard lighting panelboard mains configurations, sizes, electrical ratings and accessories are available.

For more information, visit www.eaton.com/lightingcontrol.

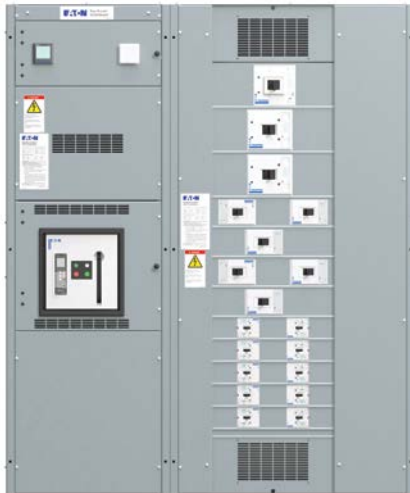

Pow-R-Line Xpert Switchboard Chassis



Distribution Dry-Type Transformers



Building Management System

Pow-R-Line Xpert Switchboard Chassis

Eaton's Pow-R-Line Xpert switchboards combine integrated insulated case circuit breakers, molded case circuit breakers, metering, surge protection and various Eaton products for dependable electrical distribution and protection. Available in maximum 6000 A main bus rating and maximum 600 Vac/Vdc, the switchboards provide enhanced accuracy and reliability for optimum system coordination with electronic trip units.

For more information, consult the Pow-R-Line Xpert Design Guide, or visit www.eaton.com/switchboards.

Distribution Dry-Type Transformers

All of Eaton's IFS transformers are specifically designed to meet Federal Energy Efficiency requirements for voltage transformation as near as practically possible to the load, for economy and distribution of power.

Eaton's types DS-3 (single-phase) and DT-3 (three-phase) general purpose ventilated dry-type transformers are of the two-winding type, self-cooled, and are available in a wide variety of primary and secondary voltage combinations. General purpose transformers are designed, manufactured and tested in accordance with all of the latest applicable ANSI, NEMA and IEEE standards, and are designed for continuous operation at rated kVA.

For more information, visit www.eaton.com/transformers.

Miscellaneous and Custom Devices

Eaton's IFS switchboards can be configured to include additional equipment, including:

- Automatic transfer switches
- UPS (Uninterruptible Power Supplies)
- Service entrance equipment
- Surge protective devices
- HVAC control
- Power factor correction
- Generator Quick Connect
- Customer metering
- Lighting power reduction products
- Contactors
- Building management systems

Depending upon the application, other user-defined equipment may also be incorporated upon request.

Integrated Facility System (IFS) Switchboards Layout Guide

IFS Switchboard Sections and Selection

- From the following pages, select the appropriate section "Type" based on system requirements
- Select from panelboards, blank steel backpans and dry-type distribution transformers by "cell"
- Layout IFS sections near standard distribution sections
- Indicate on drawings and one-line diagrams the connections from feeder devices to the appropriate cell

IFS Switchboard Section Type Layout Dimensions

Section	Page
Type 1 and 2 Sections	21.5-20
Type 3 and 4 Sections	21.5-22
Type 5 and 6 Sections	21.5-23
Type 7 and 8 Sections	21.5-24
Type 9 Sections	21.5-25
Type 10 and 11 Sections	21.5-26
Type 12 Sections	21.5-27

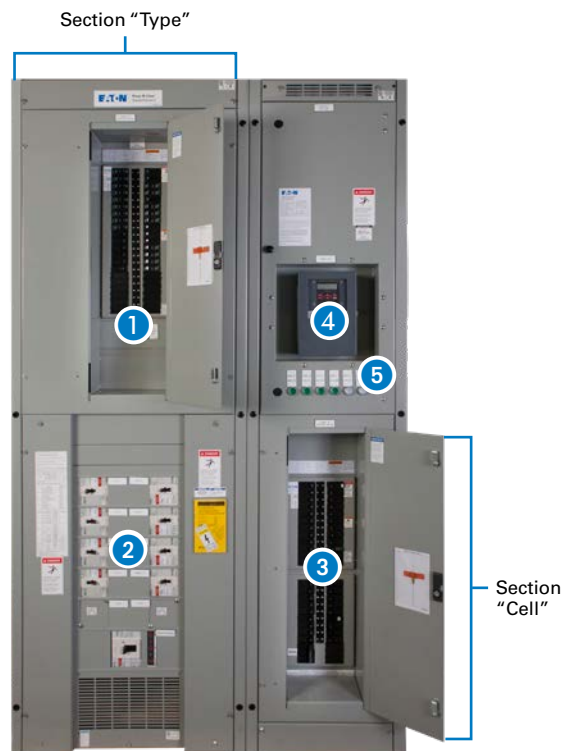

IFS Switchboard Assembly Example

- ① High-voltage panelboard
- ② Service entrance panelboard
- ③ Standard panelboard
- ④ Time clock for controlling PRC breakers
- ⑤ Lighting control override switches

Integrated Facility System Switchboards Distribution Section Layout—Type 1 and 2

Eaton’s Pow-R-Line panelboard integration—factory wired from feeder device in adjacent section(s) to panelboards. Standard features include lockable trim doors and factory-mounted overcurrent devices.

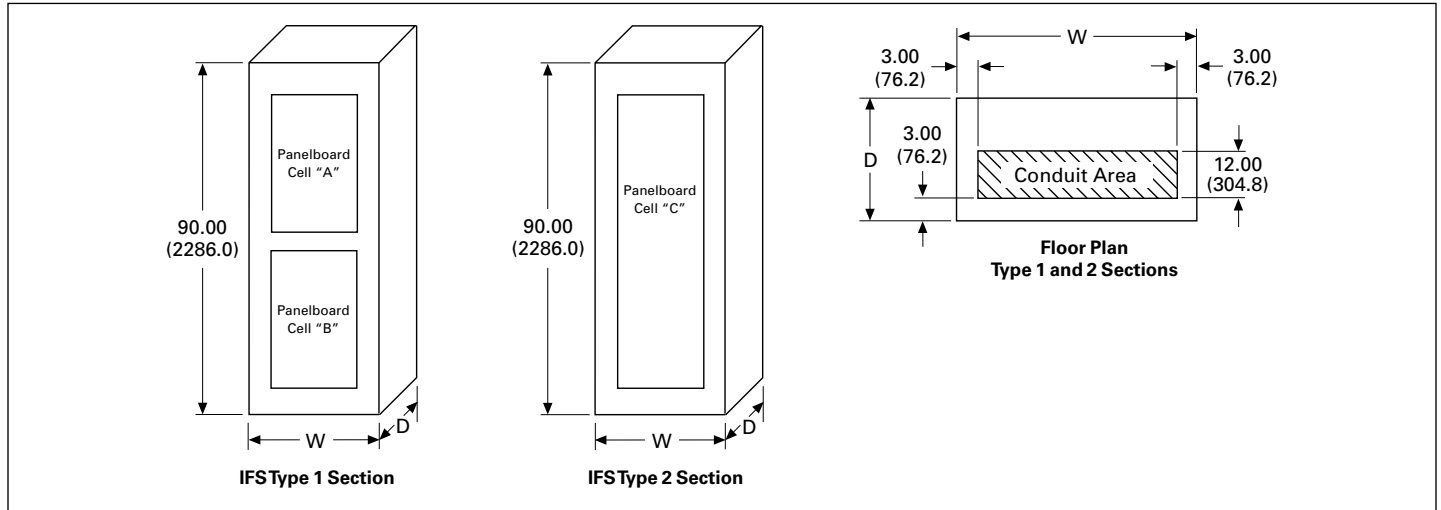

Figure 21.5-5. Type 1 and 2 Integrated Facility System Switchboards Distribution Section Layout—Dimensions in Inches (mm)

Table 21.5-15. IFS Type 1 Allowable Configurations (Select One “Panelboard Type” per Panelboard “Cell”)—Dimensions in Inches (mm)

Panel Cell	Panelboard Type	Reference Catalog Section	Maximum Voltage Rating AC	Main Device Type	Maximum Main Rating Amperes	Branch Circuits Ampere Range	Allowable Panelboard Modifications	Width Dimensions (W)		Depth Dimensions (D)		Section Height
								Standard	Optional	Standard	Optional	
IFS Type 1 Section												
A or B ^①	Pow-R-Line 1X ^②	27	240	MLO	600	15–100	③④⑤	26 (660.4)	30 (762.0)	18 (457.2)	13 (330.2)	90 (2286.0)
				Breaker	600			20 (508.0)	26 (660.4) 30 (762.0)		24 (609.6) 30 (762.0) 36 (914.4)	
	Pow-R-Line 2X ^②	27	480Y/277	MLO	600	15–100	③④⑤	26 (660.4)	30 (762.0)	18 (457.2)	13 (330.2)	90 (2286.0)
				Breaker	600			20 (508.0)	26 (660.4) 30 (762.0)		24 (609.6) 30 (762.0) 36 (914.4)	
	Pow-R-Command ^②	28	240 480Y/277	MLO	225	15–100	③④⑤	26 (660.4)	30 (762.0) 36 (914.4)	18 (457.2)	13 (330.2) 24 (609.6) 30 (762.0) 36 (914.4)	90 (2286.0)

- ① Pow-R-line 3E available. Contact Eaton for details.
- ② 42 branch circuits maximum.
- ③ Bus density, compression main lugs through 225 A, copper main lugs, copper bus, silver-plated copper bus, tin-plated copper bus, ground bar circuit breaker handle lockoff devices, increased bus rating, nameplates, 200% rated neutral through 225 A, permanent circuit numbers, directory frames, Panduit type loadside wireway, shunt trip breakers, through-feed lugs to panel immediately above or below, switch neutral breakers, service entrance label and surge protective device (SPD).
- ④ If panel sizing main is 48.00 inches (1219.2 mm) or less, the panel will fit in a half section. If it is 72.00 inches (1828.8 mm), you must use a full section. If it is 60.00 inches (1524.0 mm), contact Eaton for structure dimensions.
- ⑤ Optional hinged panelboard door available on 26.00-inch (660.4 mm) wide structures.

Table 21.5-15. IFS Type 2 Allowable Configurations (Select One “Panelboard Type” per Panelboard “Cell”)—Dimensions in Inches (mm) (Continued)

Panel Cell	Panelboard Type	Reference Catalog Section	Maximum Voltage Rating AC	Main Device Type	Maximum Main Rating Amperes	Branch Circuits Ampere Range	Allowable Panelboard Modifications	Width Dimensions (W)		Depth Dimensions (D)		Section Height
								Standard	Optional	Standard	Optional	
IFS Type 2 Section												
C ①	Pow-R-Line 1X ②	27	240	Breaker	600	15–100	③④	26 (660.4)	30 (762.0)	18 (457.2)	13 (330.2) 24 (609.6) 30 (762.0) 36 (914.4)	90 (2286.0)
	Pow-R-Line 2X ②	27	480Y/277	Breaker	600	15–100	③④	26 (660.4)	30 (762.0)	18 (457.2)	13 (330.2) 24 (609.6) 30 (762.0) 36 (914.4)	90 (2286.0)
	Pow-R-Command ②	28	480Y/277	MLO	400	15–100	③④	26 (660.4)	30 (762.0)	18 (457.2)	13 (330.2) 24 (609.6) 30 (762.0) 36 (914.4)	90 (2286.0)
				Breaker	225							
	Pow-R-Line 3X	27	480Y/277	MLO	600	15–225	③④	26 (660.4)	30 (762.0)	18 (457.2)	13 (330.2) 24 (609.6) 30 (762.0) 36 (914.4)	90 (2286.0)
				Breaker	600							
				MLO	800	15–225	③④	30 (762.0)	36 (914.4)	18 (457.2)	13 (330.2) 24 (609.6) 30 (762.0) 36 (914.4)	90 (2286.0)
	Pow-R-Line 3X Energy Management and EV Charging	27	240	MLO	600	20–40	③	30 (762.0)	36 (914.4)	18 (457.2)	24 (609.6) 30 (762.0) 36 (914.4)	90 (2286.0)
				Breaker	600							
				MLO	800	20–40	③	30 (762.0)	36 (914.4)	18 (457.2)	24 (609.6) 30 (762.0) 36 (914.4)	90 (2286.0)

① Pow-R-Line 3E available. Contact Eaton for details.

② 42 branch circuits maximum.

③ Bus density, compression main lugs through 225 A, copper main lugs, copper bus, silver-plated copper bus, tin-plated copper bus, ground bar circuit breaker handle lockoff devices, increased bus rating, nameplates, 200% rated neutral through 225 A, permanent circuit numbers, directory frames, Panduit type loadside wireway, shunt trip breakers, through-feed lugs to panel immediately above or below, switch neutral breakers, service equipment label and surge protective device (SPD).

④ If panel sizing with non-interchange main is 48.00 inches (1219.2 mm) or less, the panel will fit in a half section. If it is 72.00 inches (1828.8 mm), you must use a full section. If it is 60.00 inches (1524.0 mm), contact Eaton for cell height.

Integrated Facility System Switchboards Distribution Section Layout—Type 3 and 4

Eaton’s Pow-R-Line panelboard and transformer integration—factory wired from feeder device in adjacent sections. Standard features include lockable trim doors and factory-mounted overcurrent devices.

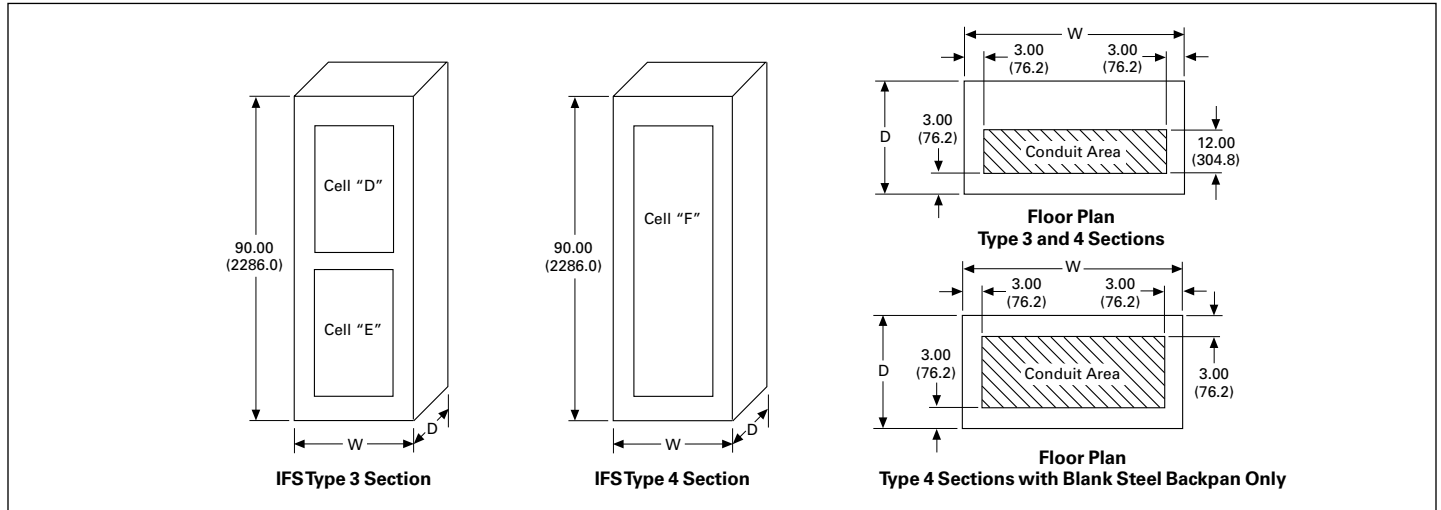

Figure 21.5-6. Type 3 and 4 Integrated Facility System Switchboards Distribution Section Layout—Dimensions in Inches (mm)

Table 21.5-16. IFS Type 3 and 4 Allowable Configurations (Select One “Panelboard Type” per Panelboard “Cell”)—Dimensions in Inches (mm)

Panel Cell	Panelboard Type	Reference Catalog Section	Maximum Voltage Rating AC	Main Device Type	Maximum Main Rating Amperes	Branch Circuits Ampere Range	Allowable Panelboard Modifications	Width Dimensions (W)		Depth Dimensions (D)		Section Height	
								Standard	Optional	Standard	Optional		
IFSType 3 Section													
D or E ①	Pow-R-Line 1X ②	27	240	MLO	600	15–100	②④⑤⑥	26 (660.4)	30 (762.0)	18 (457.2)	13 (330.2)	90 (2286.0)	
				Breaker	600			20 (508.0)	26 (660.4) 30 (762.0)		24 (609.6) 30 (762.0) 36 (914.4)		
	Pow-R-Line 2X ②	27	480Y/277	MLO	600	15–100	②④⑤⑥	26 (660.4)	30 (762.0)	18 (457.2)	13 (330.2)		
				Breaker	600			20 (508.0)	26 (660.4) 30 (762.0)		24 (609.6) 30 (762.0) 36 (914.4)		
	Blank Steel Backpan ③	—	—	—	None	—	—	⑦	20 (508.0)	30 (762.0)	18 (457.2)		13 (330.2)
										26 (660.4) 30 (762.0)			24 (609.6) 30 (762.0) 36 (914.4)
IFSType 4 Section													
F	Blank Steel Backpan ③	—	—	None	—	—	⑦	20 (508.0)	26 (660.4) 30 (762.0)	18 (457.2)	13 (330.2) 24 (609.6) 30 (762.0) 36 (914.4)	90 (2286.0)	

- ① Pow-R-Line 3E panelboard available. Contact Eaton for details.
- ② 42 branch circuits maximum.
- ③ Possible uses: HVAC, dimming and contactors. Contact Eaton for details.
- ④ Bus density, compression main lugs through 225 A, copper main lugs, copper bus, silver-plated copper bus, tin-plated copper bus, ground bar circuit breaker handle lockoff devices, increased bus rating, nameplates, 200% rated neutral through 225 A, permanent circuit numbers, directory frames, Panduit type loadside wireway, shunt trip breakers, through-feed lugs to panel immediately above or below, switch neutral breakers, service equipment label and surge protective device (SPD).
- ⑤ If panel sizing is 48.00 inches (1219.2 mm) or less, the panel will fit in a half section. If it is 72.00 inches (1828.8 mm), you must use a full section. If it is 60.00 inches (1524.0 mm), contact Eaton for cell height.
- ⑥ Optional hinged panelboard door available on 26.00-inch (660.4 mm) wide structures.
- ⑦ Galvanized steel backpan provided for customer specified equipment. Contact Eaton for requirements and details.

Integrated Facility System Switchboards Distribution Section Layout—Type 5 and 6

Eaton’s Pow-R-Line panelboard and transformer integration—factory wired from feeder device in adjacent sections. Standard features include lockable trim doors and factory-mounted overcurrent devices.

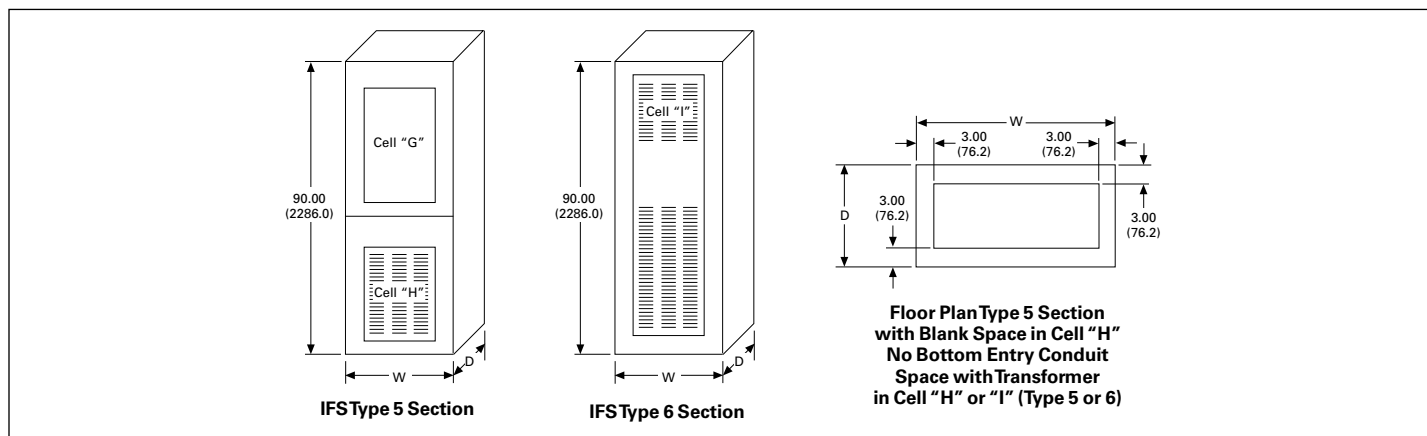

Figure 21.5-7. Type 5 and 6 Integrated Facility System Switchboards Distribution Section Layout—Dimensions in Inches (mm)

Table 21.5-17. IFS Type 5 Allowable Configurations (Select One “Panelboard Type” per Panelboard “Cell”)—Dimensions in Inches (mm)

Panel Cell	Panelboard Type	Reference Catalog Section	Maximum Voltage Rating AC	Main Device Type	Maximum Main Rating Amperes	Branch Circuits Ampere Range	Allowable Panelboard Modifications	Width Dimensions (W)		Depth Dimensions (D)		Section Height
								Standard	Optional	Standard	Optional	
G ①	Pow-R-Line 1X ②	27	240	MLO	600	15–100	④	26 (660.4)	30 (762.0)	24 (609.6)	30 (762.0)	90 (2286.0)
				Breaker							36 (914.4)	
	Pow-R-Line 2X ②	27	480Y/277	MLO	600	15–100	④	26 (660.4)	30 (762.0)	24 (609.6)	30 (762.0)	90 (2286.0)
				Breaker							36 (914.4)	
Blank Steel Backpan ③	—	—	—	None	—	—	③	26 (660.4)	30 (762.0)	24 (609.6)	30 (762.0) 36 (914.4)	90 (2286.0)
Pow-R-Command ②	28	240, 480Y/277	—	MLO	225	15–100	③④	26 (660.4)	30 (762.0) 36 (914.4)	24 (609.6)	30 (762.0) 36 (914.4)	90 (2286.0)

① Pow-R-Line 3E panelboard available. Contact Eaton for details.

② 42 branch circuits maximum.

③ Galvanized steel backpan provided for customer specified equipment. Contact Eaton for requirements and details.

④ Bus density, compression main lugs through 225 A, copper main lugs, copper bus, silver-plated copper bus, tin-plated copper bus, ground bar circuit breaker handle lockoff devices, increased bus rating, nameplates, 200% rated neutral through 225 A, permanent circuit numbers, directory frames, Panduit type loadside wireway, shunt trip breakers, through-feed lugs to panel immediately above or below, switch neutral breakers, hinged panelboard door on 26.00-inch (660.4 mm) wide sections, service entrance label and surge protective device (SPD).

Note: Select one “Panelboard Type” or one “Blank Steel Backpan” and either one “Transformer” or one “Blank Space” per “Cell”.

Table 21.5-18. IFS Type 5 and 6 General Purpose Dry-Type Distribution Transformers—Dimensions in Inches (mm)

Panel Cell	Panelboard Type	Reference Catalog Section	Temperature Rise	Windings	kVA Range	Full Cap Taps		Allowable Modifications	Width Dimensions (W)		Depth Dimensions (D)		Section Height
						FCAN	FCBN		Standard	Optional	Standard	Optional	
H ⑤	DT-3 Transformer ⑥ TP1, 480: 208Y/120 Vac	19	150 °C Only ⑦	Aluminum	15–45	4–2.5%	2–2.5%	⑤	26 (660.4)	30 (762.0)	24 (609.6)	30 (762.0) 36 (914.4)	90 (2286.0)
					75	4–2.5%	2–2.5%	⑤	30 (762.0)	N/A			
					112.5	4–2.5%	2–2.5%	⑤	36 (914.4)	N/A	30 (762.0)	36 (914.4)	90 (2286.0)
					150	4–2.5%	2–2.5%	⑤	36 (914.4)	N/A	30 (762.0)	36 (914.4)	90 (2286.0)
	Blank Steel Backpan ⑥	—	—	—	None	—	—	⑤	26 (660.4)	30 (762.0)	24 (609.6)	30 (762.0) 36 (914.4)	90 (2286.0)
I	DT-3 Transformer TP1, 480: 208Y/120 Vac	19	150 °C ⑦	Aluminum	225	4–2.5%	2–2.5%	⑤	36 (914.4)	N/A	30 (762.0)	N/A	90 (2286.0)
					300	4–2.5%	2–2.5%	⑤	45 (1143.0)	N/A	36 (914.4)		

⑤ Copper windings, 115 °C, 80 °C, K-Factor, low sound are available options but may change dimensions.

⑥ Galvanized steel backpan provided for customer specified equipment. Contact Eaton for requirements and details.

⑦ Contact Eaton for other Temperature Rise Transformers and Specials.

Note: 480:208Y/120 Vac three-phase or 480:120/240 Vac single-phase.

Integrated Facility System Switchboards Distribution Section Layout—Type 7 and 8

Eaton’s Pow-R-Line panelboard integration—factory wired from feeder device in adjacent section(s) to Panelboard Cell “J.” Distribution Chassis in Cell “K” may be field wired or wired from an adjacent section. Standard features include lockable trim doors and factory-mounted overcurrent devices.

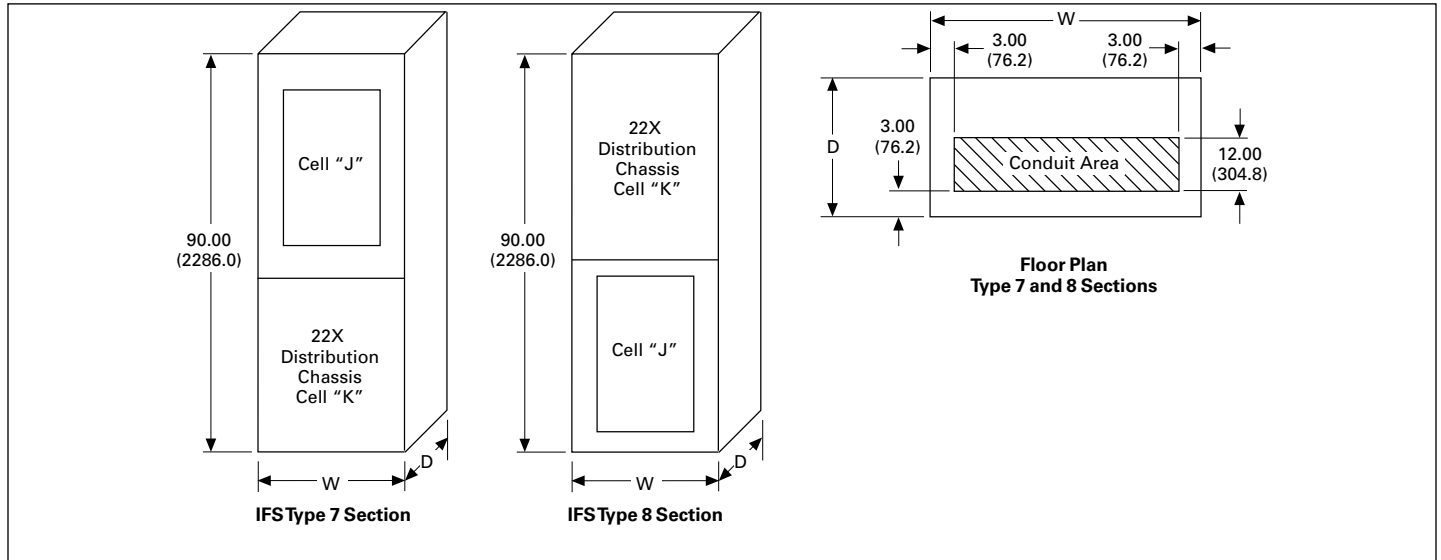

Figure 21.5-8. Type 7 and 8 Integrated Facility System Switchboards Distribution Section Layout—Dimensions in Inches (mm)

Table 21.5-19. IFS Type 7 and 8 Sections Allowable Configurations (Select One “Panelboard Type” per Panelboard “Cell”)—Dimensions in Inches (mm)

Panel Cell	Panelboard Type	Reference Catalog Section	Maximum Voltage Rating AC	Main Device Type	Maximum Main Rating Amperes	Branch Circuits Ampere Range	Allowable Panelboard Modifications	Width Dimensions (W)		Depth Dimensions (D)		Section Height
								Standard	Optional	Standard	Optional	
J ①	Pow-R-Line 1X ②	27	240	MLO	600	15–100	③④	26 (660.4)	30 (762.0)	18 (457.2)	13 (330.2)	90 (2286.0)
				Breaker	600						24 (609.6)	
	Pow-R-Line 2X ②	27	480Y/277	MLO	600	15–100	③④	26 (660.4)	30 (762.0)	18 (457.2)	13 (330.2)	90 (2286.0)
				Breaker	600						24 (609.6)	
	Pow-R-Command ②	28	240, 480Y/277	MLO	225	15–100	③④	26 (660.4)	30 (762.0)	18 (457.2)	13 (330.2)	90 (2286.0)
				Breaker	600						24 (609.6)	
K	Pow-R-Line X Switchboard Chassis ②	—	480Y/277	MLO	800	15–600	⑤	26 (660.4)	36 (914.4)	18 (457.2)	13 (330.2)	90 (2286.0)
				Breaker	600						24 (609.6)	
				MLO or Breaker	1200	15–600	⑤	36 (914.4)	45 (1143.0)	18 (457.2)	13 (330.2)	24 (609.6)

① Pow-R-Line 3E available. Contact Eaton for details.

② 42 branch circuits maximum.

③ Bus density, compression main lugs through 225 A, copper main lugs, copper bus, silver-plated copper bus, tin-plated copper bus, ground bar circuit breaker handle lockoff devices, increased bus rating, nameplates, 200% rated neutral through 225 A, permanent circuit numbers, directory frames, Panduit type loadside wireway, shunt trip breakers, through-feed lugs, switch neutral breakers, hinged panelboard door on 26.00-inch (660.4 mm) wide sections, service entrance label and surge protective device (SPD).

④ If panel sizing main is 48.00 inches (1219.2 mm) or less, the panel will fit in a half section. If it is 72.00 inches (1828.8 mm), you must use a full section. If it is 60.00 inches (1524.0 mm), contact Eaton to see if it will fit.

⑤ Reference the Pow-R-Line Xpert Switchboard Design Guide for full selection criteria.

Integrated Facility System Switchboards Distribution Section Layout—Type 9

Eaton’s Pow-R-Line panelboard integration—factory wired from feeder device in adjacent section(s). Standard features include lockable trim doors and factory-mounted overcurrent devices.

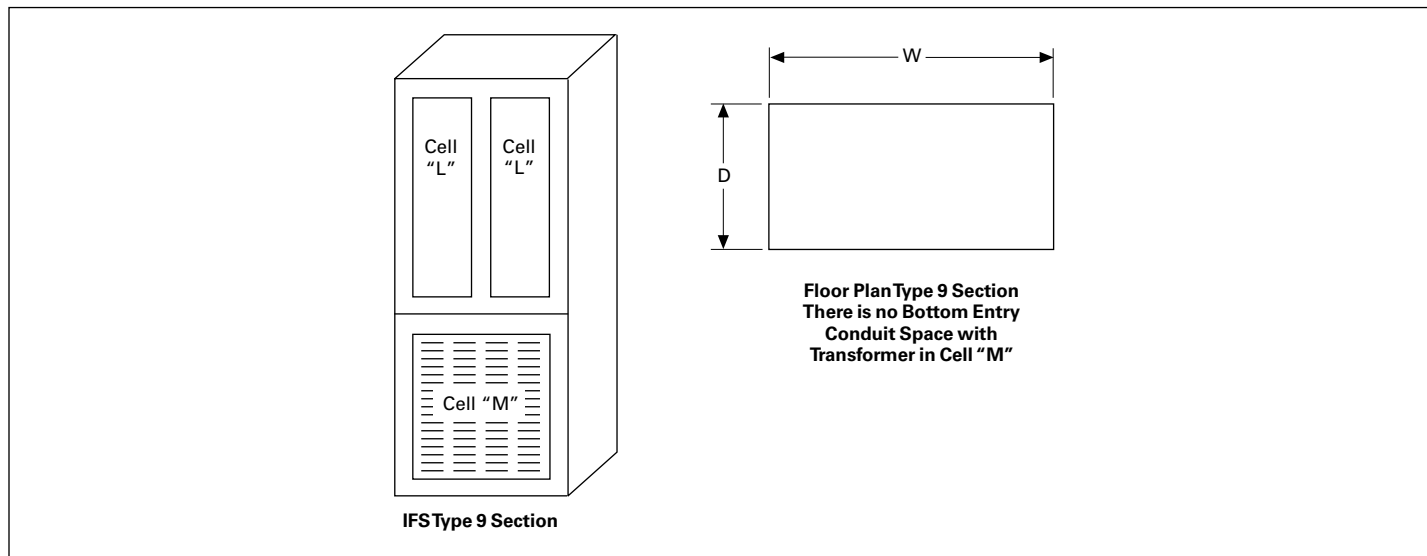

Figure 21.5-9. Type 9 Integrated Facility System Switchboards Distribution Section Layout—Dimensions in Inches (mm)

Table 21.5-20. IFS Type 9 Section Panelboard Over Dry-Type Transformer (Select One “Panelboard Type” per Panelboard “Cell”)—Dimensions in Inches (mm)

Panel Cell	Panelboard Type	Reference Catalog Section	Maximum Voltage Rating AC	Main Device Type	Maximum Main Rating Amperes	Branch Circuits Ampere Range	Allowable Panelboard Modifications	Width Dimensions (W)		Depth Dimensions (D)		Section Height
								Standard	Optional	Standard	Optional	
IFS Type 9 Section												
L ①	Pow-R-Line 1X ②	27	240	MLO	600	15–100	③	36 (914.4)	45 (1143.0)	24 (609.6)	30 (762.0)	90 (2286.0)
				Breaker	600			45 (1143.0)	—		36 (914.4)	
	Pow-R-Line 2X ②	27	480Y/277	MLO	600	15–100	③	36 (914.4)	45 (1143.0)	24 (609.6)	30 (762.0)	90 (2286.0)
Breaker				600	45 (1143.0)			—	36 (914.4)			
	Pow-R-Command ②	27	240, 480Y/277	MLO	225	15–100	③	26 (660.4)	30 (762.0) 36 (914.4)	18 (457.2)	13 (330.2) 24 (609.6) 30 (762.0) 36 (914.4)	90 (2286.0)

① Pow-R-Line 3E panelboard available. Contact Eaton for details.

② 42 branch circuits maximum.

③ Bus density, compression main lugs through 225 A, copper main lugs, copper bus, silver-plated copper bus, tin-plated copper bus, ground bar circuit breaker handle lockoff devices, increased bus rating, nameplates, 200% rated neutral through 100 A, permanent circuit numbers, directory frames, Panduit type loadside wireway, shunt trip breakers, through-feed lugs, switch neutral breakers.

Table 21.5-21. IFS Type 9 Section General Purpose Dry-Type Distribution Transformers—Dimensions in Inches (mm)

Panel Cell	Transformer Type	Reference Catalog Section	Temperature Rise	Windings	kVA Range	Full CapTaps		Allowable Modifications	Width Dimensions (W)		Depth Dimensions (D)		Section Height
						FCAN	FCBN		Standard	Optional	Standard	Optional	
IFS Type 9 Section													
M	DT-3 Transformer TP-1 480: 208Y/120 Vac	19	150 °C Only ④	Aluminum	15–75	4–2.5%	2–2.5%	⑤	36 (914.4)	45 (1143.0)	24 (609.6)	30 (762.0) 36 (914.4)	90 (2286.0)
					112.5	4–2.5%	2–2.5%	⑤	36 (914.4)	45 (1143.0)	36 (914.4)	—	90 (2286.0)

④ Contact Eaton for other Temperature Rise Transformers and Specials.

⑤ Copper windings, 115 °C, 80 °C, K-Factor, and low sound TP-1 are available options but may change dimensions.

Integrated Facility System Switchboards Distribution Section Layout—Type 10 and 11

Eaton’s Pow-R-Line panelboard integration—factory wired from feeder device in adjacent section(s) to Panelboard Cell “J.” Distribution Chassis in Cell “K” may be field wired or wired from an adjacent section. Standard features include lockable trim doors and factory-mounted overcurrent devices.

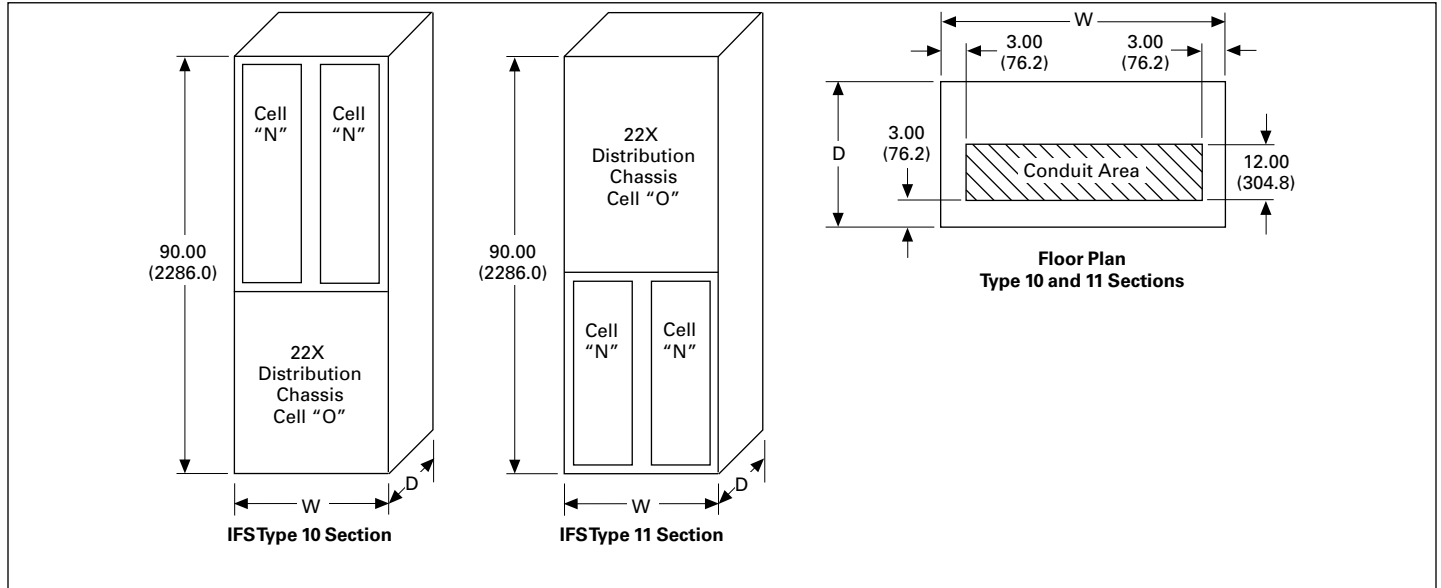

Figure 21.5-10. Type 10 and 11 Integrated Facility System Switchboards Distribution Section Layout—Dimensions in Inches (mm)

Table 21.5-22. IFS Type 10 and 11 Sections Allowable Configurations (Select One “Panelboard Type” per Panelboard “Cell”)—Dimensions in Inches (mm)

Panel Cell	Panelboard Type	Reference Catalog Section	Maximum Voltage Rating AC	Main Device Type	Maximum Main Rating Amperes	Branch Circuits Ampere Range	Allowable Panelboard Modifications	Width Dimensions (W)		Depth Dimensions (D)		Section Height
								Standard	Optional	Standard	Optional	
IFSTypes 10 and 11 Sections												
N ①	Pow-R-Line 1X ②	27	240	MLO	600	15–100	③④	45 (1143.0)	—	18 (457.2)	13 (330.2)	90 (2286.0)
				Breaker	600			36 (914.4)	45 (1143.0)		24 (609.6)	
	Pow-R-Line 2X ②	27	480Y/277	MLO	600	15–100	③④	45 (1143.0)	—	18 (457.2)	13 (330.2)	90 (2286.0)
				Breaker	600			36 (914.4)	45 (1143.0)		24 (609.6)	
	Pow-R-Command ②	28	240, 480Y/277	MLO	225	15–100	③④	45 (1143.0)	36 (914.4)	18 (457.2)	13 (330.2)	90 (2286.0)
				Breaker	600			36 (914.4)	45 (1143.0)		24 (609.6)	
O	Pow-R-Line X Switchboard Chassis	—	480Y/277	MLO	800	15–600	⑤	36 (914.4)	45 (1143.0)	18 (457.2)	13 (330.2)	90 (2286.0)
				Breaker	600			36 (914.4)	45 (1143.0)		24 (609.6)	
				MLO or Breaker	1200	15–600	⑤	36 (914.4)	45 (1143.0)	18 (457.2)	13 (330.2)	24 (609.6)

① Pow-R-Line 3E available. Contact Eaton when applicable.
 ② 42 branch circuits maximum.
 ③ Bus density, compression main lugs through 225 A, copper main lugs, copper bus, silver-plated copper bus, tin-plated copper bus, ground bar circuit breaker handle lockoff devices, increased bus rating, nameplates, 200% rated neutral through 225 A, permanent circuit numbers, directory frames, Panduit type loadside wireway, shunt trip breakers, through-feed lugs, switch neutral breakers, hinged trim, service entrance label and surge protective device (SPD).
 ④ If panel sizing is 48.00 inches (1219.2 mm) or less, the panel will fit in a half section. If it is 72.00 inches (1828.8 mm), you must use a full section. If it is 60.00 inches (1524.0 mm), contact Eaton to see if it will fit.
 ⑤ Reference the Pow-R-Line Xpert Switchboard Design Guide for full selection criteria.

Integrated Facility System Switchboards Distribution Section Layout—Type 12

Eaton’s Pow-R-Line panelboard integration—factory wired from feeder device in adjacent section(s). Standard features include lockable trim doors and factory-mounted overcurrent devices.

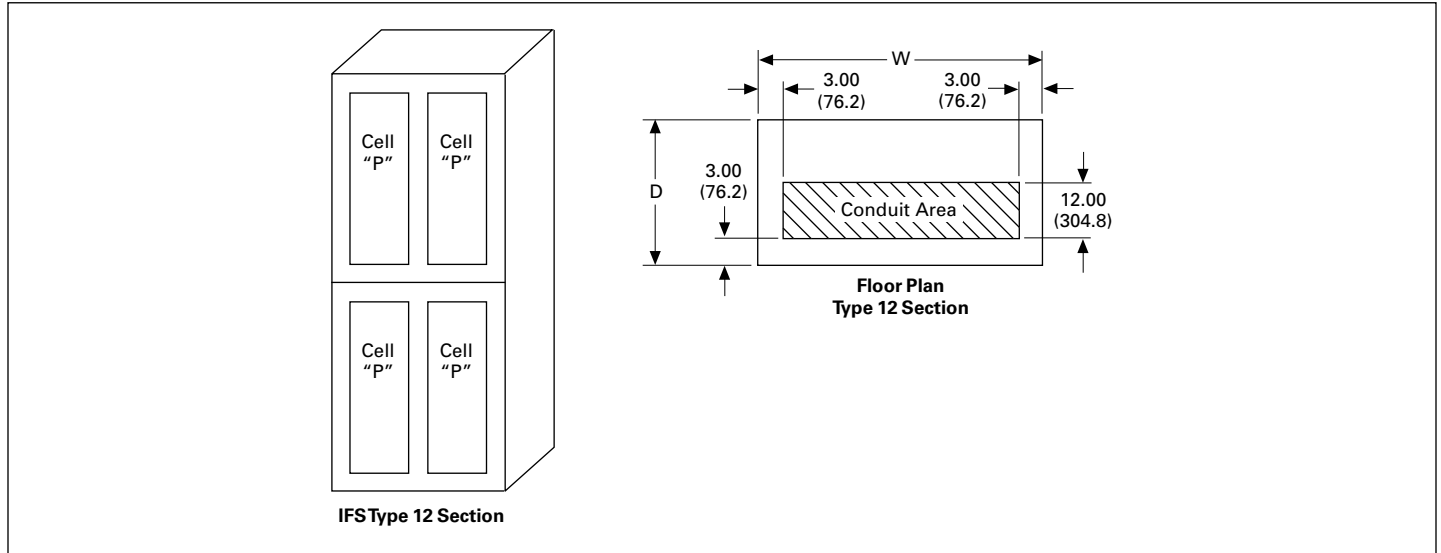

Figure 21.5-11. Type 12 Integrated Facility System Switchboards Distribution Section Layout—Dimensions in Inches (mm)

Table 21.5-23. IFS Type 12 Section Allowable Configurations (Select One “Panelboard Type” per Panelboard “Cell”)—Dimensions in Inches (mm)

Panel Cell	Panelboard Type	Reference Catalog Section	Maximum Voltage Rating AC	Main Device Type	Maximum Main Rating Amperes	Branch Circuits Ampere Range	Allowable Panelboard Modifications	Width Dimensions (W)		Depth Dimensions (D)		Section Height
								Standard	Optional	Standard	Optional	
P ①	Pow-R-Line 1X ②	27	240	MLO	600	15–100	③④⑤	45 (1143.0)	—	18 (457.2)	13 (330.2)	90 (2286.0)
				Breaker	600			36 (914.4)	45 (1143.0)		24 (609.6)	
	Pow-R-Line 2X ②	27	480Y/277	MLO	600	15–100	③④⑤	45 (1143.0)	—	18 (457.2)	13 (330.2)	
				Breaker	600			36 (914.4)	45 (1143.0)		24 (609.6)	
	Pow-R-Command ②	28	240, 480Y/277	MLO	225	15–100	③④⑤	45 (1143.0)	36 (914.4)	18 (457.2)	13 (330.2)	
											24 (609.6)	
										30 (762.0)		
										36 (914.4)		

① Pow-R-Line 3E available. Reference Section 27. Contact Eaton when applicable.

② 42 branch circuits maximum.

③ Bus density, compression main lugs through 225 A, copper main lugs, copper bus, silver-plated copper bus, tin-plated copper bus, ground bar circuit breaker handle lockoff devices, increased bus rating, nameplates, 200% rated neutral through 225 A, permanent circuit numbers, directory frames, Panduit type loadside wireway, shunt trip breakers, through-feed lugs, switch neutral breakers, hinged trim, service entrance label and surge protective device (SPD).

④ If panel sizing is 48.00 inches (1219.2 mm) or less, the panel will fit in a half section. If it is 72.00 inches (1828.8 mm), you must use a full section. If it is 60.00 inches (1524.0 mm), contact Eaton for structure dimensions.

⑤ If any single-phase is selected as 400 A or PRC, section minimum width is 45.00 inches (1143.0 mm).

Eaton
 1000 Eaton Boulevard
 Cleveland, OH 44122
 United States
 Eaton.com

© 2023 Eaton
 All Rights Reserved
 Printed in USA
 Publication No. DG015005EN / Z28118
 October 2023



Eaton is a registered trademark.

All other trademarks are property of their respective owners.