

Fuller Heavy Duty Transmissions TRSM0310

October 2007



Powering Business Worldwide

BACKED BY

Roadranger

SUPPORT

TABLE OF CONTENTS

FOREWORD

MODEL DESIGNATIONS AND SPECIFICATIONS

LUBRICATION

OPERATION

POWER FLOW

TIMING

TORQUE RECOMMENDATIONS

TOOL REFERENCE

PREVENTIVE MAINTENANCE

PRECAUTIONS

DISASSEMBLY

INSPECTION

REASSEMBLY

CHANGING INPUT SHAFT

AIR SYSTEM

RANGE SHIFT AIR SYSTEM

AIR SYSTEM SCHEMATICS

DISASSEMBLY AND REASSEMBLY—SHIFTING CONTROLS

AIR SYSTEM

GEAR SHIFT LEVER HOUSING ASSEMBLY

SHIFT BAR HOUSING ASSEMBLY

REMOVAL – COMPANION FLANGE, AUXILIARY SECTION AND CLUTCH HOUSING

DISASSEMBLY – AUXILIARY SECTION

REASSEMBLY – AUXILIARY SECTION

DISASSEMBLY – FRONT SECTION

REASSEMBLY – FRONT SECTION

INSTALLATION—COMPANION FLANGE, AUXILIARY SECTION AND CLUTCH HOUSING

INSTALLATION—SHIFTING CONTROLS

SHIFT BAR HOUSING ASSEMBLY

GEAR SHIFT LEVER HOUSING ASSEMBLY

AIR SYSTEM

FOREWORD

This manual is designed to provide detailed information necessary to service and repair the Fuller® Transmissions listed on the cover.

As outlined in the Table of Contents, the manual is divided into 3 main sections:

- a. Technical information and reference
- b. Removal, disassembly, reassembly and installation
- c. Options

The format of the manual is designed to be followed in its entirety if complete disassembly and reassembly of the transmission is necessary. But if only one component of the transmission needs to be repaired, refer to the Table of Contents for the page numbers showing that component. For example, if you need to work on the Shift Bar Housing, you will find instructions for removal, disassembly and reassembly on page 34. Instructions for installation are on page 100. Service Manuals, Illustrated Parts Lists, Drivers Instructions, Driver Training

Programs and other forms of product service information for these and other Fuller Transmissions are available upon request. A Technical Literature Order Form may be found in the back of this manual*. You may also obtain Service Bulletins, detailing information on product improvements, repair procedures and other service-related subjects by writing to the following address:

EATON CORPORATION
TRANSMISSION DIVISION
Technical Service Department
P.O. Box 4013
Kalamazoo, Michigan 49003
(616) 342-3344

MODEL DESIGNATIONS AND SPECIFICATIONS

Nomenclature:

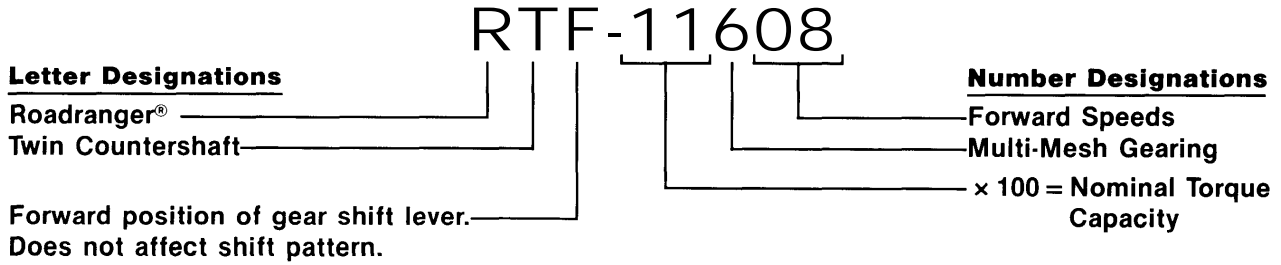

IMPORTANT: All Fuller Transmissions are identified by model and serial number. This information is stamped on the transmission identification tag and affixed to the case.
DO NOT REMOVE OR DESTROY THE TRANSMISSION IDENTIFICATION TAG.

8 Speed Series Transmissions

Models	No. Spds	Gear Ratios									(Note 1) Relative Speed PTO Gear To Input R PM		(Note 2)	(Note 3)	(Note 4)
		1st	2nd	3rd	4th	5th	6th	7th	8th	Reverse	Right	Bottom	In <i>mm</i>	Lbs <i>kg</i>	Pints <i>Liters</i>
RT-11608	8	1023	723	524	382	267	1 89	1 37	1 00	3 33/12 74	575	575	289 734	578 262	26 12
RT-14608	8	1023	723	524	382	267	1 89	1 37	1 00	3 33/12 74	575	575	295 749	604 274	28 13

See Chart Notes.

CHART NOTES:

- 1 Lengths measured from face of clutch housing to front bottoming surface of companion flange or yoke.
- 2 Weights include SAE No. 1 cast iron clutch housing and standard controls (control valve, gear shift lever and housing assembly, and air lines), less clutch release parts. For information on available clutch housings, refer to Publication FUL-140 —"Clutch Housing Chart." All weights are approximate.
- 3 Oil Capacities are approximate, depending on inclination of engine and transmission. Always fill transmission with proper grade and type of lubricant to level of filler opening. See LUBRICATION.

LUBRICATION

Proper Lubrication... the Key to long transmission life

Proper lubrication procedures are the key to a good all-around maintenance program. If the oil is not doing its job, or if the oil level is ignored, all the maintenance procedures in the world are not going to keep the transmission running or assure long transmission life.

Fuller Transmissions are designed so that the internal parts operate in a bath of oil circulated by the motion of gears and shafts. Grey iron parts have built-in channels where needed, to help lubricate bearings and shafts.

Thus, all parts will be amply lubricated if these procedures are closely followed:

1. **Maintain oil level. Inspect regularly.**
2. **Change oil regularly.**
3. **Use the correct grade and type of oil.**
4. **Buy from a reputable dealer.**

Lubrication Change and Inspection	
HIGHWAY USE	
First 3,000 to 5,000 miles (4827 to 8045 Km)	Change transmission oil on new units
Every 10,000 miles (16090 Km)	Inspect oil level. Check for leaks.
Every 50,000 miles (80450 Km)	Change transmission oil.
OFF-HIGHWAY USE	
First 30 hours	Change transmission oil on new units.
Every 40 hours	Inspect oil level. Check for leaks.
Every 500 hours	Change transmission oil where severe dirt conditions exist.
Every 1,000 hours	Change transmission oil (Normal off-highway use).

Change oil filter element, if so equipped, at each oil change

Oil is Important...

Here are some of the functions oil must perform:

- Provide a protective film—To protect surface of heavily loaded parts such as gear teeth and bearings, thus preventing metal to metal contact which causes scoring, scuffing and seizure.
- Act as a coolant—To dissipate heat and reduce heat by reducing friction.
- Afford sufficient fluidity—To follow, coat and cushion all loaded surfaces.
- Be chemically stable—To withstand heat and agitation without separation, gumming-up, oxidizing or corroding.
- Be non-foaming—To prevent excessive foam and increased volume under severe conditions.
- Be free of sediment and water—To prevent sludge and rust.

Recommended Lubricants		
Type	Grade (SAE)	Fahrenheit (Celsius) Ambient Temperature
Heavy Duty Engine Oil MIL-L-2104B or MIL-L-2104C or API-SF or API-CD (Previous API designations acceptable)	50 40 30	Above 10°F.(-12°C.) Above 10°F.(-12°C.) Below 10°F.(-12°C.)
Mineral Gear Oil with rust and oxidation inhibitor API-GL-1	90 80W	Above 10°F.(-12°C.) Below 10°F.(-12°C.)
Mild EP Gear Oil MIL-L-2105 or API-GL-4	90 80W	10°F.(-12°C.) to 100°F.(38°C.) -15°F.(-26°C.) to 70°F.(21°C.)
Multipurpose Gear Oil MIL-L-2105B or MIL-L-2105C or API-G L-5	85W140 80W140 90 80W90 80W 75W	Above 10°F.(-12°C.) Above -15°F.(-26°C.) 10°F.(-12°C.) to 100°F.(38°C.) -15°F.(-26°C.) to 100°F.(38°C.) -15°F.(-26°C.) to 70°F.(21°C.) -40°F.(-40°C.) to -15°F.(-26°C.)

Additives, friction modifiers or synthetic lubricants are not recommended for use in Fuller Transmissions.

*Mild EP Gear Oil or Multi-Purpose Gear Oil are not recommended when lubricant operating temperatures are above 230°F (110°C).

LUBRICATION

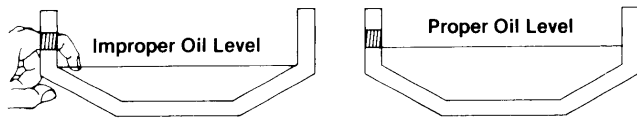

Proper Oil Level

Make sure oil is level with filler opening. Because you can reach oil with your finger does not mean oil is at proper level. **One inch of oil level is about one gallon of oil.**

Draining Oil

Drain transmission while oil is warm. To drain oil remove the drain plug at bottom of case. Clean the drain plug before reinstalling.

Refilling

Clean case around filler plug and remove plug from side of case. Fill transmission to the level of the filler opening. If transmission has two filler openings, fill to level of both openings on twin countershaft models.

The exact amount of oil will depend on the transmission inclination and model. *In every instance, fill to the level of the filler opening.*

Do not over fill—this will cause oil to be forced out of the case through front bearing cover.

When adding oil, types and brands of oil should not be intermixed because of possible incompatibility.

Operating Temperatures

The transmission should not be operated consistently at temperatures above 250°F (120°C). However, intermittent operating temperatures to 300°F (149°C) will not harm the transmission. Operating temperatures above 250°F increase the lubricant's rate of oxidation and shorten its effective life. When the transmission is operated intermittently above 250°, heavy duty engine oil provides the best oxidation resistance. When the average operating temperature is above 250°F, the transmission may require more frequent oil changes or external cooling.

The following conditions in any combination can cause operating temperatures of over 250°F: (1) operating consistently at slow speeds, (2) high ambient temperatures, (3) restricted air flow around transmission, (4) exhaust system too close to transmission, (5) high horsepower, overdrive operation.

External oil coolers are available to reduce operating temperatures when the above conditions are encountered.

Proper Lubrication Levels as Related to Operating Angles

If the transmission operating angle is more than 12 degrees, improper lubrication can occur. The operating angle is the transmission mounting angle in the chassis plus the percent of upgrade (expressed in degrees).

The chart below illustrates the safe percent of upgrade on which the transmission can be used with various chassis mounting angles. For example: if you have a 4 degree transmission mounting angle, then 8 degrees (or 14 percent of grade) is equal to the limit of 12 degrees. If you have a 0 degree mounting angle, the transmission can be operated on a 12 degree (21 percent) grade.

Anytime the transmission operating angle of 12 degrees is exceeded for an extended period of time the transmission should be equipped with an oil pump or cooler kit to insure proper lubrication.

Note on the chart the effect low oil levels can have on safe operating angles. Allowing the oil level to fall 1/2" below the filler plug hole reduces the degree of grade by approximately 3 degrees (5.5 percent).

Proper Lubrication Levels are Essential!

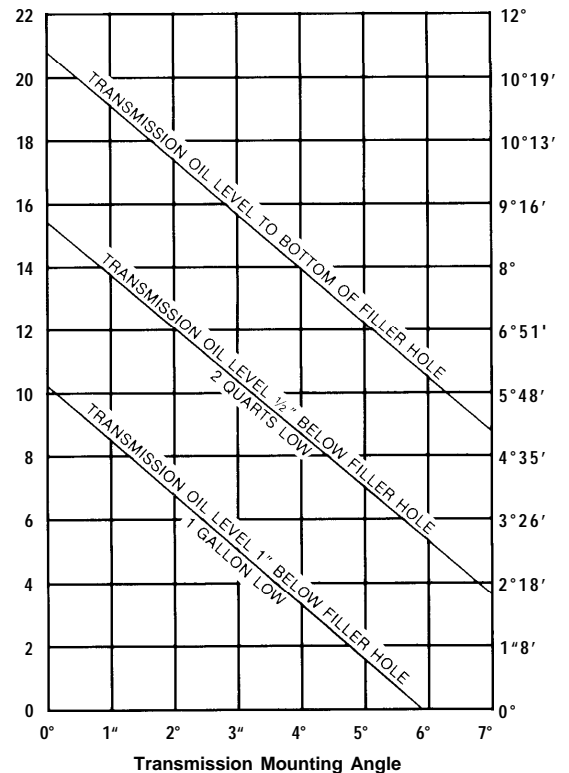

OPERATION

8-Speed Transmissions

Shift Lever Patterns and Shifting Controls

RT (Direct) Models

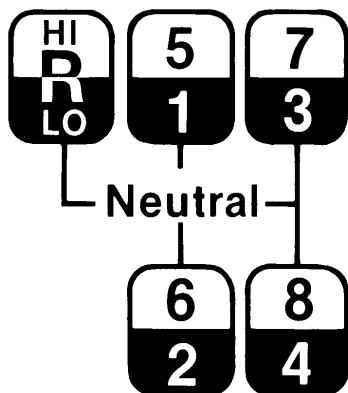

Shift 1-2=3-4 in LOW RANGE.
Range Shift . . .
And shift 5-6-7-8 in HIGH RANGE.

Range Control Valve (A-3546)

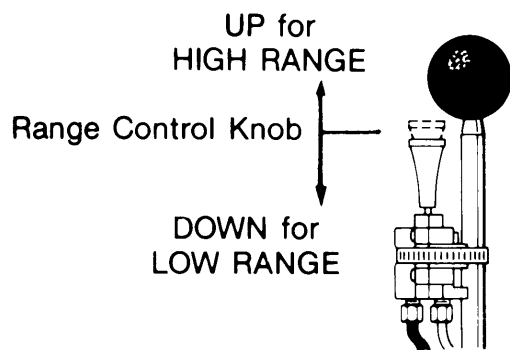

Range Control Valve (A-5010)

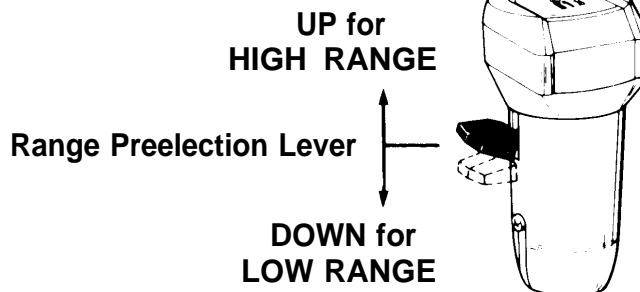

POWER FLOW

The transmission must efficiently transfer the engine's power, in terms of torque, to the vehicle's rear wheels. Knowledge of what takes place in the transmission during torque transfer is essential when trouble-shooting and making repairs become necessary.

Front Section Power Flow

1. Power (torque) from the vehicle's engine is transferred to the transmission's input shaft.
2. Splines of input shaft engage internal splines in hub of main drive gear.
3. Torque is split between the two countershaft drive gears.
4. Torque is delivered along both countershaft to mating countershaft gears of "engaged" mainshaft gear. The following cross section views (Figures 1-3) illustrate a 1st/5th speed gear engagement.
5. Internal clutching teeth in hub of engaged mainshaft gear transfers torque to mainshaft through sliding clutch.
6. Mainshaft transfers torque directly to auxiliary drive gear.

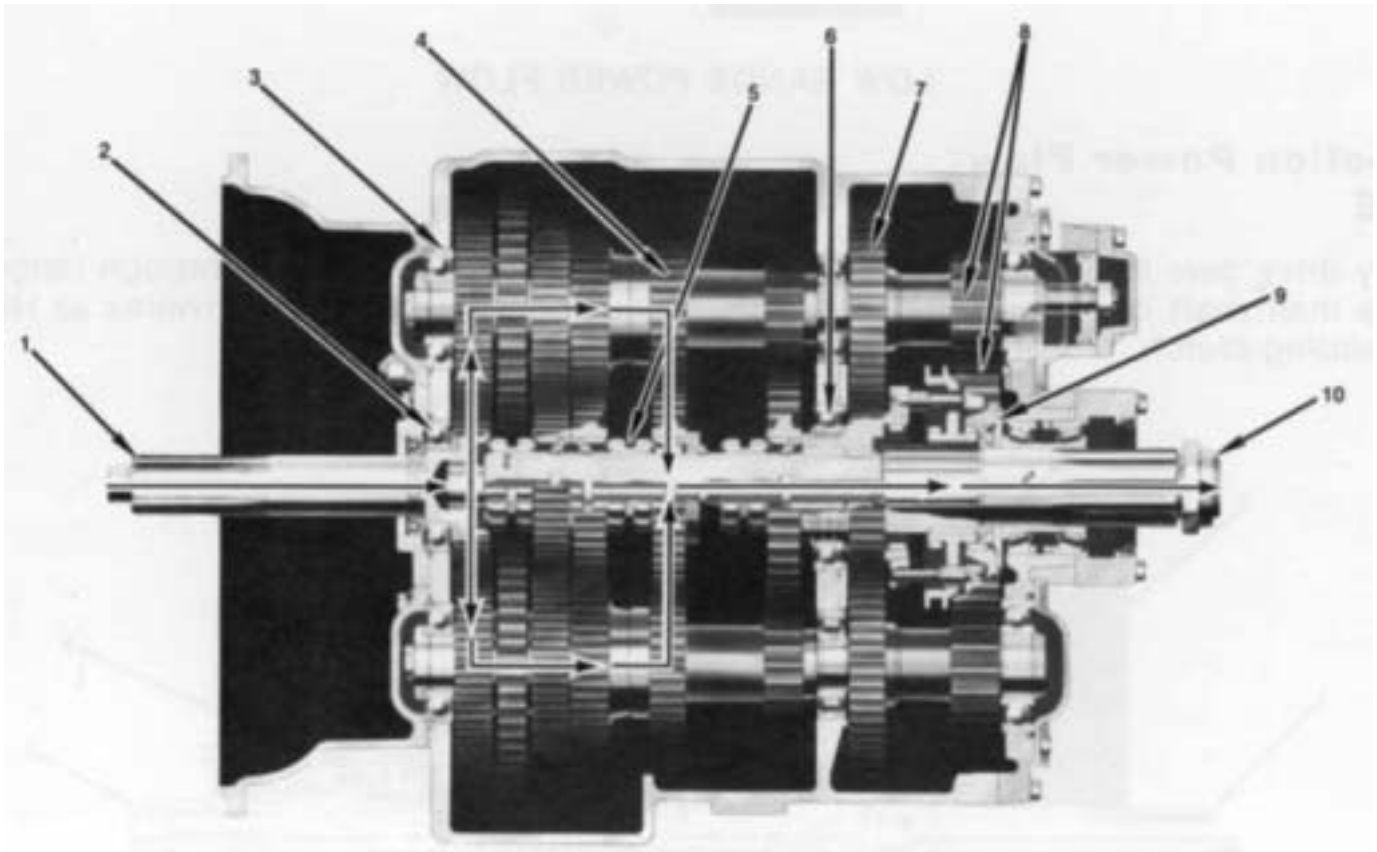

POWER FLOW

Auxiliary Section Power Flow: LOW RANGE

7. The auxiliary drive gear splits torque between the two auxiliary countershaft drive gears.
8. Torque is delivered along both countershaft to the "engages" low range gear on range mainshaft or output shaft.
9. Torque is transferred to range mainshaft or output shaft through sliding clutch.
10. Torque is delivered to driveline as LOW RANGE 1st.

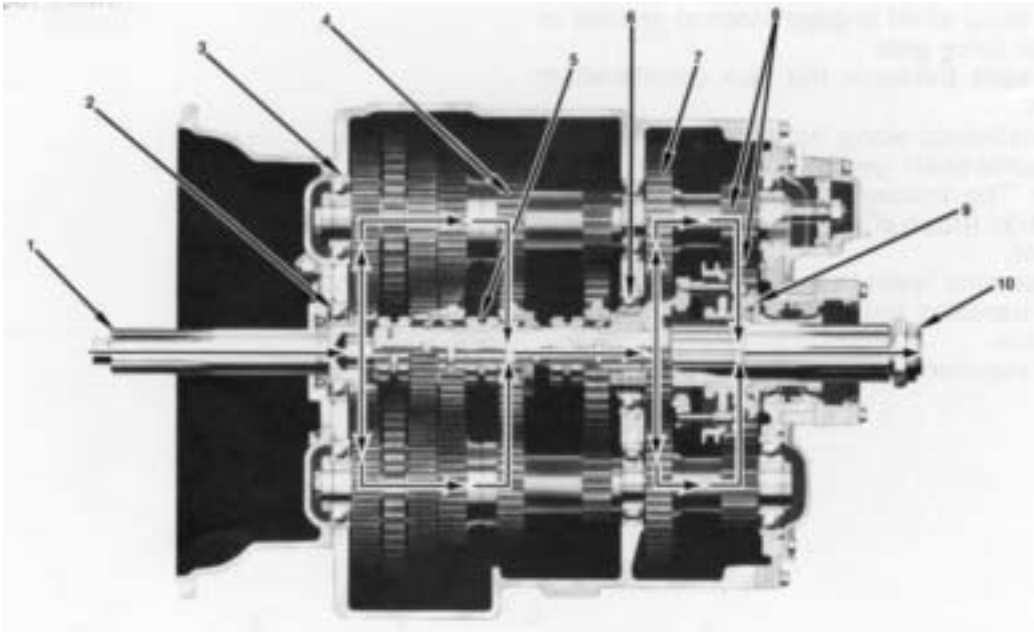

Auxiliary Section Power Flow: HIGH RANGE

7. The auxiliary drive gear transfers torque directly to the range mainshaft or output shaft through "engaged" sliding clutch.
8. Torque is delivered through range mainshaft and/or output shaft to driveline as HIGH RANGE 5th.

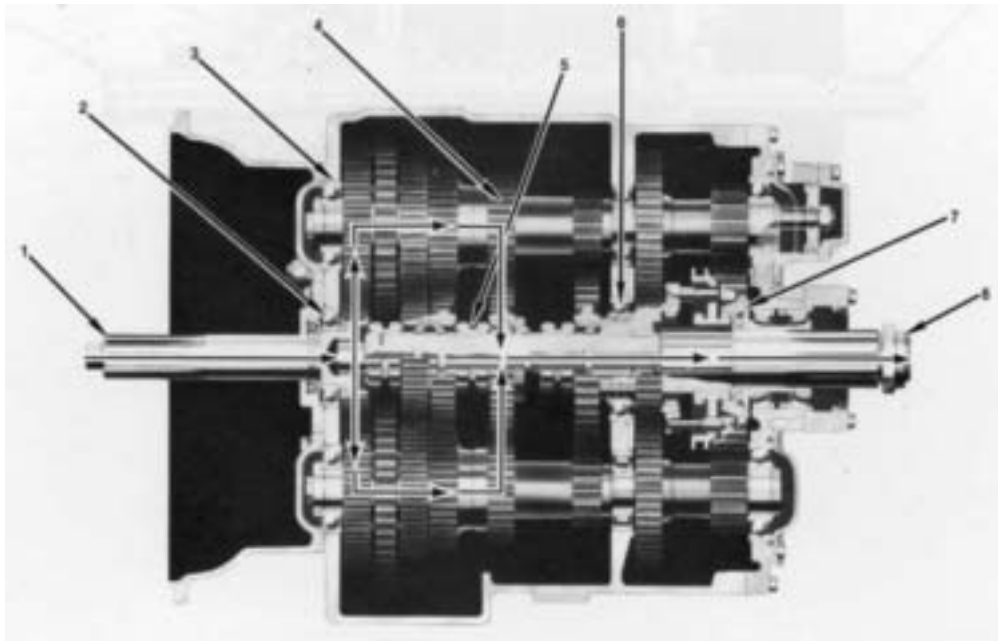

HIGH RANGE POWER FLOW

TIMING

Timing Procedures: All Models

All Fuller twin countershaft transmissions are "timed" at assembly. It is important that proper timing procedures are followed when reassembling the transmission. Timing assures that the countershaft gears will contact the mating mainshaft gears at the same time, allowing mainshaft gears to center on the mainshaft and equally divide the load.

Timing is a simple procedure of marking the appropriate teeth of a gear set prior to installation and placing them in proper mesh while in the transmission. In the front section, it is necessary to time only the drive gear set. And depending on the model, only the low range or deep reduction gear set is timed in the auxiliary section.

Front Section

A. Marking countershaft drive gear teeth.

1. Prior to placing each countershaft assembly into case, clearly mark the tooth located directly over the keyway of drive gear as shown. This tooth is stamped with an "O" to aid identification.

A. TOOTH MARKED ON EACH COUNTERSHAFT DRIVE GEAR FOR TIMING PURPOSES

Cut 7300

B. Marking main drive gear teeth.

1. Mark *any* two adjacent teeth on the main drive gear.
2. Mark the two adjacent teeth located directly opposite the first set marked on the main drive gear. As shown below, there should be an equal number of unmarked gear teeth on each side between the marked sets.

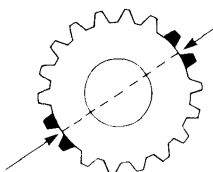

Cut 7300A

B. TEETH MARKED ON MAIN DRIVE GEAR FOR TIMING PURPOSES

C. Meshing marked countershaft drive gear teeth with marked main drive gear teeth.

(After placing the mainshaft assembly into case, the countershaft bearings are installed to complete installation of the countershaft assemblies.)

1. When installing the bearings on left countershaft, mesh the marked tooth of countershaft drive gear with either set or two marked teeth on the main drive gear.
2. Repeat the procedure when installing the bearings on right countershaft, making use of the remaining set of two marked teeth on the main drive gear to time assembly.

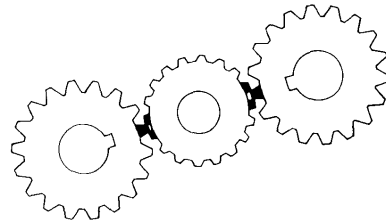

Cut 7300B

C. DRIVE GEAR SET PROPERLY TIMED

Auxiliary Section

A. Timing the low range gear set.

1. Mark *any* two adjacent teeth on the mainshaft gear of set to be timed. Then mark the two adjacent teeth located directly opposite the first set marked as shown in Illustration B.
2. Prior to placing each auxiliary countershaft assembly into housing, mark the tooth stamped with an "O" on gear to mate with timed mainshaft gear as shown in Illustration A.
3. Install the mainshaft gear in position on range mainshaft OR output shaft.
4. Partially seat the countershaft rear bearings in housing bores.
5. Place the auxiliary countershaft assemblies into position and mesh the marked teeth of mating countershaft gears with the marked teeth of mainshaft gear as shown in Illustration C.
6. Fully seat the rear bearings on each countershaft to complete installation.

TORQUE RECOMMENDATIONS

Correct torque application is extremely important to assure low transmission life and dependable Performance. Over-tightening or under-tightening can result in a loose installation and, in many instances, eventually cause damage to transmission gears, shafts, and/or bearings. Use a torque wrench whenever possible to attain recommended lbs./ft. ratings. Do not torque capscrews dry.

FRONT SECTION: ALL MODELS

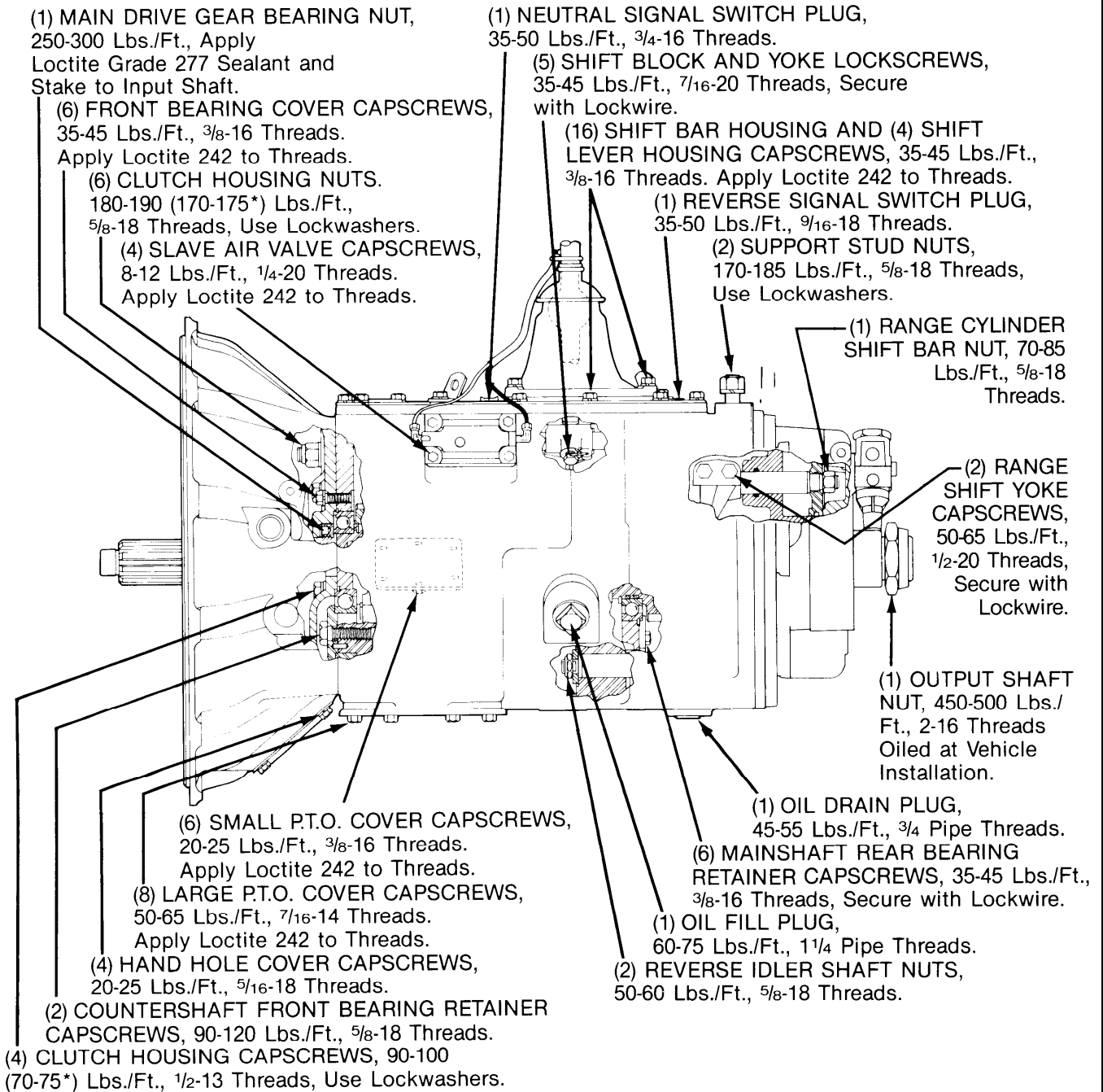

*With Aluminum Clutch Housing

TORQUE RECOMMENDATIONS

AUXILIARY

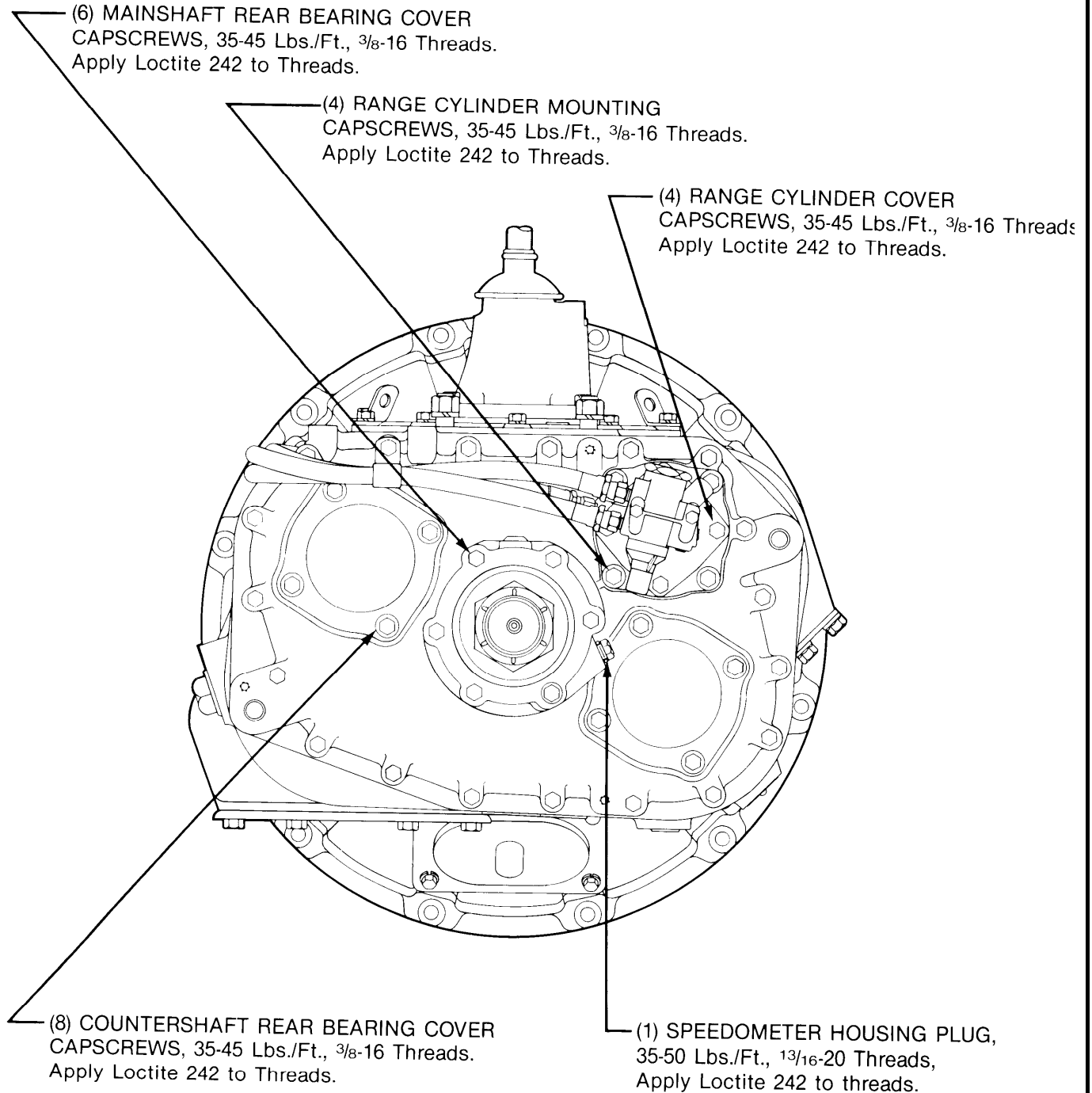

TOOL REFERENCE

Some repair procedures pictured in this manual show the use of specialized tools. Their actual use is recommended as they make transmission repair easier, faster, and prevent costly damage to critical parts.

But for the most part, ordinary mechanic's tools such as socket wrenches, screwdrivers, etc., and other standard shop items such as a press, mauls and soft bars are all that is needed to successfully disassemble and reassemble any Fuller Transmission.

The specialized tools listed below can be obtained from a tool supplier or made from dimensions as required by the individual user. Detailed Fuller Transmission Tool Prints are available upon request by writing.

Eaton Corporation
Transmission Division
Technical Service Dept.
P.O. Box 4013
Kalamazoo, Michigan 49003

PAGE	TOOL	HOW OBTAINED
4 0	Auxiliary Section Hanger Bracket	Made from Fuller Transmission Print T-22823
4 0	Output Shaft Hanger Bracket	Made from Stop Nut and flat steel stock
3 3	Tension Spring Driver	Made from Fuller Transmission Print T-11938
4 5	Snap Ring Pliers	Tool Supplier
4 6	Bearing Puller (Jaw Type)	Tool Supplier
6 3	Impact Puller (1/2-1 3 Threaded End)	Tool Supplier
5 3	Bearing Drivers (Flanged-End)	Made from Fuller Transmission Print Series T-10842*
5 3	Oil Seal Driver	Made from Fuller Transmission Print T-18088=23
7 9	Countershaft Support Tool	Made from Fuller Transmission Print T-22247
9 9	Torque Wrench, 1000 Lbs./Ft. Capacity	Tool Supplier
5 9	Input Shaft Nut Installer	Made from Fuller Transmission Print T-22553-A

*Dimensions necessary to determine specific tool number required.

PREVENTIVE MAINTENANCE

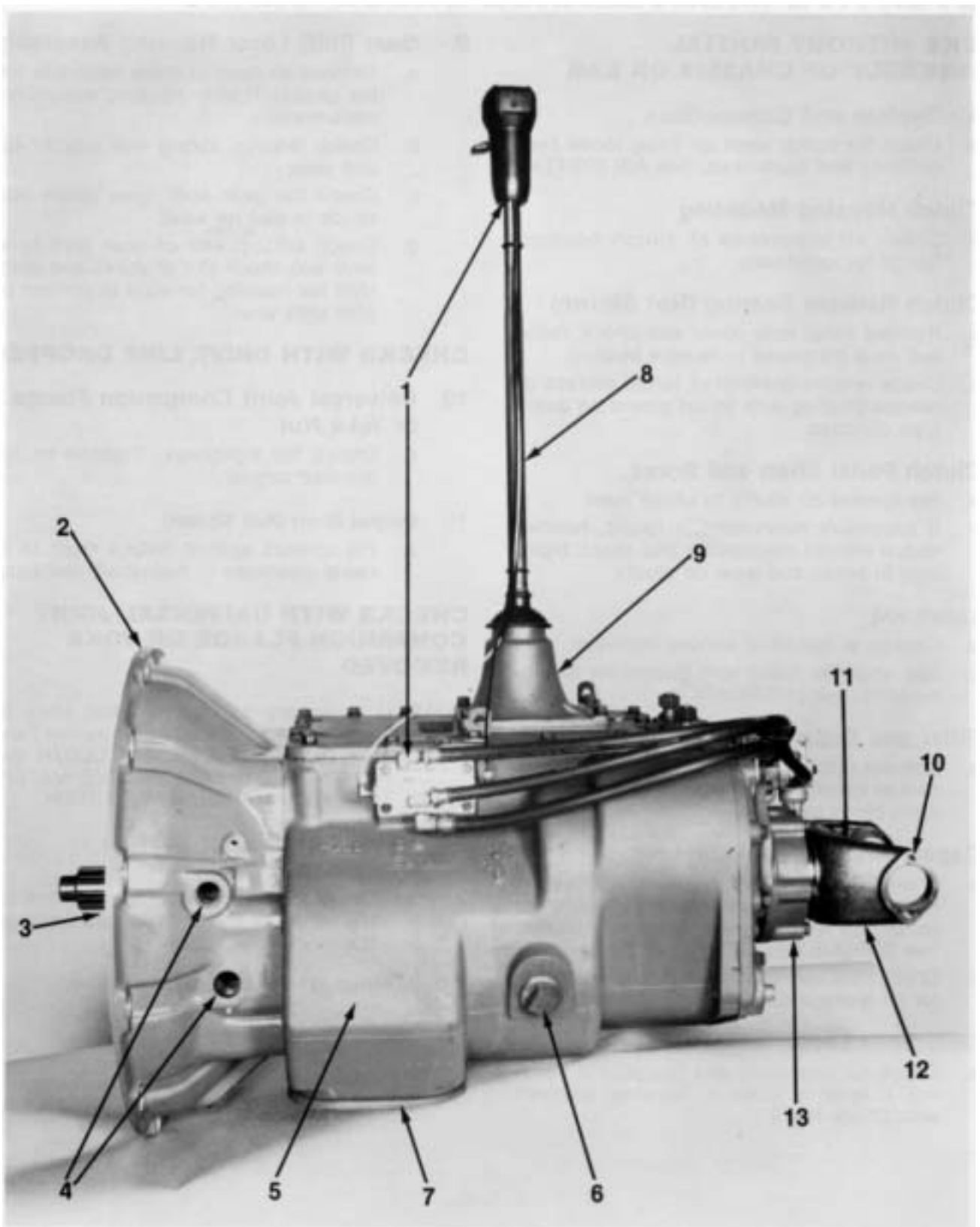

PREVENTIVE MAINTENANCE

PREVENTIVE MAINTENANCE CHECK CHART

CHECKS WITHOUT PARTIAL DISASSEMBLY OF CHASSIS OR CAB

1. **Air System and Connections**
 - a. Check for leaks, worn air lines, loose connections and capscrews. See AIR SYSTEM.
2. **Clutch Housing Mounting**
 - a. Check all capscrews of clutch housing flange for looseness.
3. **Clutch Release Bearing (Not Shown)**
 - a. Remove hand hole cover and check radial and axial clearance in release bearing.
 - b. Check relative position of thrust surface of release bearing with thrust sleeve on push-type clutches.
4. **Clutch Pedal Shaft and Bores**
 - a. Pry upward on shafts to check wear.
 - b. If excessive movement is found, remove clutch release mechanism and check bushings in bores and wear on shafts.
5. **Lubricant**
 - a. Change at specified service intervals.
 - b. Use only the types and grades as recommended. See LUBRICATION.
6. **Filler and Drain Plugs**
 - a. Remove filler plugs and check level of lubricant at specified intervals. Tighten filler and drain plugs securely.
7. **Capscrews and Gaskets**
 - a. Check all capscrews, especially those on PTO covers and rear bearing covers for looseness which would cause oil leakage. See TORQUE RECOMMENDATIONS.
 - b. Check PTO opening and rear bearing covers for oil leakage due to faulty gasket.
8. **Gear Shift Lever**
 - a. Check for looseness and free play in housing. If lever is loose in housing, proceed with Check No. 9.

9. Gear Shift Lever Housing Assembly

- a. Remove air lines at slave valve and remove the gear shift lever housing assembly from transmission.
- b. Check tension spring and washer for set and wear.
- c. Check the gear shift lever spade pin and spade in slot for wear.
- d. Check bottom end of gear shift lever for wear and check slot of yokes and blocks in shift bar housing for wear at contact points with shift lever.

CHECKS WITH DRIVE LINE DROPPED

10. Universal Joint Companion Flange or Yoke Nut

- a. Check for tightness. Tighten to recommended torque.

11. Output Shaft (Not Shown)

- a. Pry upward against output shaft to check radial clearance in mainshaft rear bearing.

CHECKS WITH UNIVERSAL JOINT COMPANION FLANGE OR YOKE REMOVED

NOTE: If necessary, use solvent and shop rag to clean sealing surface of companion flange or yoke. DO NOT USE CROCUS CLOTH, EMERY PAPER OR OTHER ABRASIVE MATERIALS THAT WILL MAR SURFACE FINISH.

12. Splines on Output Shaft (Not Shown)

- a. Check for wear from movement and chucking action of the universal joint companion flange or yoke.

13. Mainshaft Rear Bearing Cover

- a. Check oil seal for wear.

PRECAUTIONS

Disassembly

It is assumed in the detailed assembly instructions that the lubricant has been drained from transmission, the necessary linkage and air lines disconnected and the transmission has been removed from vehicle chassis. Removal of the gear shift lever housing assembly (or remote control assembly) is included in the detailed instructions (Disassembly and Reassembly—Shifting Controls); however, this assembly **MUST** be detached from shift bar housing before transmission can be removed.

FOLLOW CLOSELY EACH PROCEDURE IN THE DETAILED INSTRUCTIONS, MAKING USE OF THE TEXT, ILLUSTRATIONS AND PHOTOGRAPHS PROVIDED.

1. **BEARINGS** — Carefully wash and relubricate all reusable bearings as removed and protectively wrap until ready for use. Remove bearings planned to be reused with pullers designed for this purpose.
2. **ASSEMBLIES** — When disassembling the various assemblies, such as the mainshaft, countershaft, and shift bar housing, lay all parts on a clean bench in the same sequence as removed. This procedure will simplify reassembly and reduce the possibility of losing parts.
3. **SNAP RINGS** — Remove snap rings with pliers designed for this purpose. Snap rings removed in this manner can be reused, if they are not sprung or loose.
4. **INPUT SHAFT**—The input shaft can be removed from transmission without removing the countershafts, mainshaft, or main drive gear. Special procedures are required and provided in this manual.
5. **CLEANLINESS** — Provide a clean place to work. It is important that no dirt or foreign material enters the unit during repairs. Dirt is an abrasive and can damage bearings. It is always good practice to clean the outside of the unit before starting the planned disassembly.
6. **WHEN USING TOOLS TO MOVE PARTS** — Always apply force to shafts, housings, etc, with restraint. Movement of some parts is restricted. Never apply force to the part being driven after it stops solidly. The use of soft hammers, bars and mauls for all disassembly work is recommended.

Inspection

Before reassembling the transmission, check each part carefully for abnormal or excessive wear and damage to determine reuse or replacement. When replacement is necessary, use only genuine Fuller Transmission parts to assure continued performance and extended life from your unit.

Since the cost of a new part is generally a small fraction of the total cost of downtime and labor, avoid reusing a questionable part which could lead to additional repairs and expense soon after initial reassembly. To aid in determining the reuse or replacement of any transmission part, consideration should also be given to the unit's history, mileage, application, etc.

Recommended inspection procedures are provided in the following checklist.

A. BEARINGS

1. Wash all bearings in clean solvent. Check balls, rollers and raceways for pitting, discoloration, and spalled areas. Replace bearings that are pitted, discolored, or spalled.
2. Lubricate bearings that are not pitted, discolored, or spalled and check for axial and radial clearances.
Replace bearings with excessive clearances.
3. Check bearing fits. Bearing inner races should be tight to shaft; outer races slightly tight to slightly loose in case bore. If bearing spins freely in bore, however, case should be replaced.

B. GEARS

1. Check gear teeth for frosting and pitting. Frosting of gear tooth faces present no threat of transmission failure. Often in continued operation of the unit, frosted gears will "heal" and not progress to the pitting stage. And in most cases, gears with light to moderate pitted teeth have considerable gear life remaining and can be reused. But gears with advanced stage pitting should be replaced.
2. Check for gears with clutching teeth abnormally worn, tapered, or reduced in length from clashing in shifting. Replace gears found in any of these conditions.

PRECAUTIONS

Inspection (cont'd.)

3. Check axial clearance of gears. Where excessive clearance is found, check gear snap ring, washer, spacer, and gear hub for excessive wear. Maintain .005" to .012" axial clearance between mainshaft gears.

C. SPLINES

1. Check splines on all shafts for abnormal wear. If sliding clutch gears, companion flange, or clutch hub have worn into the sides of the splines, replace the specific shaft affected.

D. TOLERANCE/LIMIT WASHERS

1. Check surfaces of all limit washers. Washers scored or reduced in thickness should be replaced.

E. REVERSE IDLER GEAR ASSEMBLIES

1. Check for excessive wear from action of roller bearings.

F. GRAY IRON PARTS

1. Check all gray iron parts for cracks and breaks. Replace or repair parts found to be damaged. Heavy castings may be welded or brazed provided the cracks do not extend into bearing bores or bolting surfaces. When welding, however, never place the ground so as to allow current to pass through the transmission.

G. CLUTCH RELEASE PARTS

1. Check clutch release parts. Replace yokes worn at cam surfaces and bearing carrier worn at contact pads.
2. Check pedal shafts. Replace those worn at bearing surfaces.

H. SHIFT BAR HOUSING ASSEMBLY

1. Check for wear on shift yokes and blocks at pads and lever slot. Replace excessively worn parts.
2. Check yokes for correct alignment. Replace sprung yokes.
3. Check lockscrews in yokes and blocks. Tighten and rewire those found loose.
4. If housing has been disassembled, check neutral notches of shift bars for wear from interlock balls.

I. GEAR SHIFT LEVER HOUSING ASSEMBLY

1. Check spring tension on shift lever. Replace tension spring and washer if lever moves too freely.
2. If housing is disassembled, check spade pin and corresponding slot in lever for wear. Replace both parts if excessively worn.

J. BEARING COVERS

1. Check covers for wear from thrust of adjacent bearing. Replace covers damaged from thrust of bearing outer race.
2. Check bores of covers for wear. Replace those worn oversize.

K. OIL RETURN THREADS AND SEALS

1. Check oil return threads in front bearing cover. If sealing action of threads has been destroyed by contact with input shaft, replace bearing cover.
2. Check oil seal in mainshaft rear bearing cover. If sealing action of lip has been destroyed, replace seal.

L. SLIDING CLUTCHES

1. Check all shift yokes and yoke slots in sliding clutches for extreme wear or discoloration from heat.
2. Check engaging teeth of sliding clutches for partial engagement pattern.

M. SYNCHRONIZER ASSEMBLY

1. Check synchronizer for burrs, uneven and excessive wear at contact surface, and metal particles.
2. Check blocker pins for excessive wear or looseness.
3. Check synchronizer contact surfaces on the auxiliary drive and low range gears for excessive wear.

N. O-RINGS

1. Check all O-rings for cracks or distortion. Replace if worn.

PRECAUTIONS

Reassembly

Make sure that interiors of case and housings are clean. It is important that dirt and other foreign materials be kept out of the transmission during reassembly. Dirt is an abrasive and can damage polished surfaces of bearings and washers. Use certain precautions, as listed below, during reassembly.

1. **GASKETS** — Use new gaskets throughout the transmission as it is being rebuilt. Make sure all gaskets are installed. An omission of any gasket can result in oil leakage or misalignment of bearing covers.
2. **CAPSCREWS** — TO prevent oil leakage, use Loctite 242 thread sealant on all capscrews. For torque ratings, see TORQUE RECOMMENDATIONS.
3. **O-RINGS** — Lubricate all O-rings with silicone lubricant.
4. **ASSEMBLY** — Refer to the illustrations provided in the detailed disassembly instructions as a guide to reassembly.
5. **INITIAL LUBRICATION** — Coat all limit washers and splines of shafts with Lubriplate during reassembly to prevent scoring and galling of such parts.
6. **AXIAL CLEARANCES** — Maintain original axial clearances of .005" to .012" for mainshaft gears.
7. **BEARINGS** — Use of flanged-end bearing drivers is recommended for the installation of bearings. These special drivers apply equal force to both bearing races, preventing damage to balls/rollers and races while maintaining correct bearing alignment with bore and shaft. Avoid using a tubular or sleeve-type driver, whenever possible, as force is applied to only one of the bearing races. See TOOL REFERENCE.
8. **UNIVERSAL JOINT COMPANION FLANGE OR YOKE** — Pull the companion flange or yoke tightly into place with the output shaft nut, using 450-500 foot-pounds of torque. Make sure the speedometer drive gear or a replacement spacer of the same width has been installed. Failure to pull the companion flange or yoke tightly into place will permit the output shaft to move axially with resultant damage to the rear bearing.

IMPORTANT: REFER TO THE APPROPRIATE ILLUSTRATED PARTS LIST (SPECIFIED BY MODEL SERIES) TO ENSURE THAT PROPER PARTS ARE USED DURING REASSEMBLY OF THE TRANSMISSION.

CHANGING INPUT SHAFT

Special Procedure

In some cases, it may become necessary to replace the input shaft due to excessive clutch wear on the splines. Except for removal of the shift bar housing assembly, the input shaft can be removed without further disassembly of the transmission. Removal of the clutch housing is optional.

NOTE: The following illustration and instructions pertain to changing the input shaft ONLY. To change the main drive gear, disassembly of the front section is required.

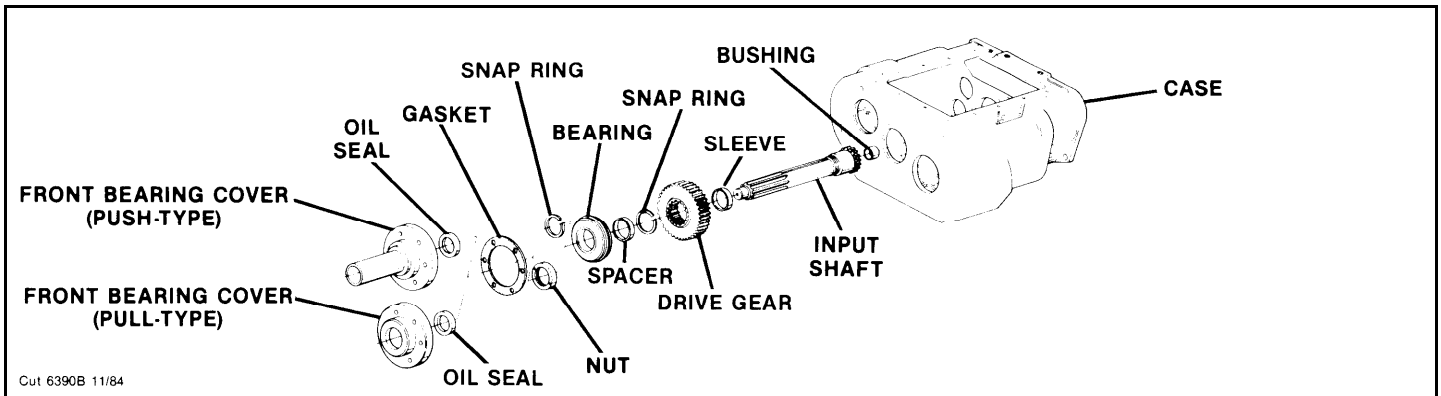

Disassembly

1. Remove the gear shift lever housing assembly (or remote control assembly) from shift bar housing, if necessary, and the shift bar housing assembly from transmission case.
2. Remove the front bearing cover and gasket. If necessary, remove the oil seal from cover of models so equipped.
3. Remove the drive gear bearing nut (left hand threads) or snap ring from input shaft.
Suggestion: For removal of nut ONLY, engage two mainshaft sliding clutches into gear to prevent the mainshaft from rotating.
4. Move the main drive gear assembly as far forward as possible and remove the drive gear bearing.
5. Remove the spacer from input shaft.
6. From the front of transmission, remove the snap ring from I.D. of main drive gear using two small screwdrivers. If mainshaft was previously locked in two gears, it may become necessary to place sliding clutches in the neutral position to rotate input shaft and mainshaft for removal of snap ring.
7. Pull the input shaft forward and from splines of drive gear.

Reassembly

1. If necessary, install bushing in pocket of input shaft.
2. Install new input shaft into splines of main drive gear just far enough to expose snap ring groove in I.D. of drive gear.
3. Install snap ring in groove of drive gear.
4. Install spacer on input shaft.
5. Using a flanged-end driver, install the drive gear bearing on shaft and into case bore. When applying force to driver, use caution so as not to damage bearing shield.
Suggestion: Engaging the sliding clutch into main drive gear and blocking it forward will hold the input shaft forward.
6. When drive gear bearing nut is used, degrease the threads of input shaft and new nut. DO NOT REUSE OLD NUT. When snap ring is used, install the snap ring in groove of input shaft and proceed to #10.
7. Apply Fuller Transmission adhesive sealant #71204 or equivalent to the cleaned threads of input shaft and nut, using caution so as not to contaminate bearing with sealant.
8. Engage two mainshaft sliding clutches into gear to prevent the mainshaft from rotating and install the new drive gear bearing nut, left-hand threads, on input shaft. Tighten nut with 250-300 Lbs./Ft. of torque.
Suggestion: To avoid damaging the O.D. of nut, use the tool specifically designed for this purpose. See TOOL REFERENCE.
9. With a punch and maul, peen the nut into the two milled slots of input shaft, using caution so as not to distort O.D. of nut.
10. To facilitate proper reinstallation of the shift bar housing assembly on case, make sure mainshaft sliding clutches are placed in the neutral position.
11. Reinstall the shift bar housing assembly, the front bearing cover and all other parts and assemblies previously removed, making sure to replace the gaskets used.

AIR SYSTEM

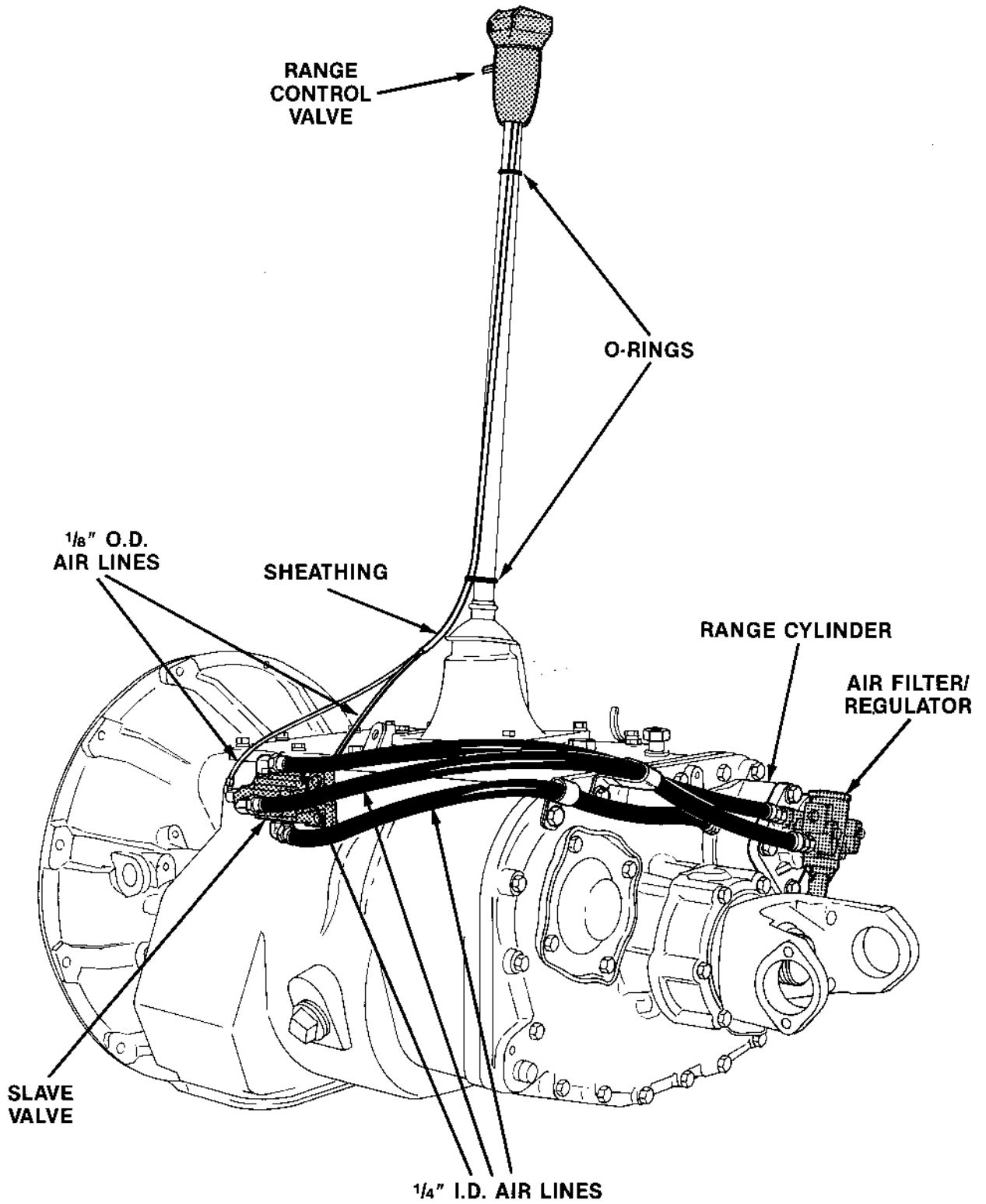

AIR SYSTEM

RANGE SHIFT AIR SYSTEM—ALL MODELS

Operation

The Range Shift Air System consists of the air filter/regulator, slave valve, a Range Control Valve, range cylinder, fittings and connecting air lines. See Air System Schematics.

CONSTANT AIR from the air filter/regulator is supplied to the "S" or Supply Port of slave valve and passed through to the INLET or "S" Port of control valve.

WHILE IN LOW RANGE, the control valve is OPEN and AIR is returned to slave valve at the "P" or End Port. This signals the valve to supply AIR in line between the Low Range or "L" Port of slave valve and the Low Range Port of range cylinder housing. AIR received at this port moves the range piston to the rear and causes the auxiliary low range gear to become engaged.

WHILE IN HIGH RANGE, the control valve is CLOSED and NO AIR is returned to the slave valve. This signals the slave valve to supply AIR in line between the High Range or "H" Port of valve and the High Range Port of range cylinder cover. AIR received at this port moves the range piston forward to engage the auxiliary drive gear with sliding clutch and bypass the low range gear set.

Range shifts can be made ONLY when the gear shift lever is in, or passing through, neutral. Thus, the range desired can be PRESELECTED while the shift lever is in a gear position. As the lever is moved through neutral, the actuating plunger in the shift bar housing releases the slave valve piston, allowing it to move to the selected range position.

Trouble Shooting

If the transmission fails to make a range shift or shifts too slowly, the fault may be in the Range Shift Air System or actuating components of the shift bar housing assembly.

To locate the trouble, the following checks should be made with normal vehicle air pressure applied to the system, but with the engine off.

CAUTION: NEVER WORK UNDER A VEHICLE WHILE ENGINE IS RUNNING as personal injury may result from the sudden and unintended movement of vehicle under power.

1. INCORRECT AIR LINE HOOK-UPS

(See Air System Schematics)

With the gear shift lever in neutral, move the control that provides range selection UP and DOWN.

- A. If the air lines are crossed between control valve and slave valve, there will be CONSTANT AIR flowing from the exhaust port of control valve WHILE IN HIGH RANGE.

- B. If the air lines are crossed between the slave valve and range cylinder, the transmission gearing will not correspond with the range selection. A LOW RANGE selection will result in a HIGH RANGE engagement and vice versa.

2. AIR LEAKS

With the gear shift lever in neutral, coat all air lines and fittings with soapy water and check for leaks, moving the control that provides range selection UP and DOWN.

- A. If there is a steady leak from the exhaust port of control valve, O-rings and/or related parts of the control valve are defective.
- B. If there is a steady leak from breather of slave valve: an O-ring in valve is defective, or there is a leak past O-rings of range cylinder piston.
- C. If transmission fails to shift into LOW RANGE or is slow to make the range shift and the case is pressurized, see Check No. 7 of this section.
- D. Tighten all loose connections and replace defective O-rings and parts.

3. AIR FILTER/REGULATOR

(See illustration, Page 22.)

With the gear shift lever in neutral, check the breather of air filter/regulator assembly. There should be NO AIR leaking from this port. The complete assembly should be replaced if a steady leak is found.

Cut off the vehicle air supply to the air filter/regulator assembly, disconnect the air line at fitting in Supply OUTLET and install an air gage in opened port. Bring the vehicle air pressure to normal. Regulated air pressure should be 57.5 to 62.5 Psi.

DO NOT ADJUST SCREW AT BOTTOM OF REGULATOR TO OBTAIN CORRECT READINGS.

The air regulator has been PREADJUSTED within the correct operating limits. Any deviation from these limits, especially with regulators that have been in operation for some time, is likely to be caused by dirt or worn parts. If replacement or cleaning of the filter element does nothing to correct the air pressure readings, replace the complete assembly, as the air regulator is nonserviceable.

4. RANGE CONTROL VALVE (See Pages 23 and 24.)

With the gear shift lever in neutral, select HIGH RANGE and disconnect the 1/8" O.D. air line at the OUTLET or "P" Port of control valve.

AIR SYSTEM

- A. When LOW RANGE is selected, a steady blast of air will flow from opened port. Select HIGH RANGE to shut off air flow. This indicates the control valve is operating properly. Reconnect air line.
- B. If control valve does not operate properly, check for restrictions and air leaks. Leaks indicate defective or worn O-rings.

5. HIGH RANGE OPERATION

With the gear shift lever in neutral, select LOW RANGE and disconnect the 1/4" I.D. air line at the port of range cylinder cover. Make sure this line leads from the High Range or "H" Port of slave valve.

- A. When HIGH RANGE is selected, a steady blast of air should flow from disconnected line. Select LOW RANGE to shut off air flow.
- B. Move the shift lever to a gear position and select HIGH RANGE. There should be NO AIR flowing from disconnected line. Return the gear shift lever to the neutral position. There should now be a steady flow of air from disconnected line. Select LOW RANGE to shut off air flow and reconnect air line.
- C. If the air system does not operate accordingly, the slave valve or actuating components of the shift bar housing assembly are defective.

IMPORTANT: RANGE PRESELECTION

The plunger pin, located in case bore between the slave valve and actuating plunger of shift bar housing, prevents the slave valve from operating while the shift lever is in a gear position. When the lever is moved to or through the neutral position, the pin is released and the slave valve becomes operational.

6. LOW RANGE OPERATION

With the gear shift lever in neutral, select HIGH RANGE and disconnect the 1/4" I.D. air line at the fitting on range cylinder housing. Make sure this line leads from the Low Range or "L" Port of slave valve.

- A. When LOW RANGE is selected, a steady blast of air should flow from disconnected line. Select HIGH RANGE to shut off air flow.
- B. Move the shift lever to a gear position and select LOW RANGE. There should be NO AIR flowing from disconnected line. Return the gear shift lever to the neutral position. There should now be a steady flow of air from disconnected line. Select HIGH RANGE to shut off air flow and reconnect air line.

- C. If the air system does not operate accordingly, the slave valve or actuating components of the shift bar housing assembly are defective.

7. RANGE CYLINDER (Refer to the following illustration.)

If any of the seals in the range cylinder assembly are defective, the range shift will be affected.

- A. Leak at either O-ring A results in complete failure to make a range shift; steady flow of air from breather of slave valve in both ranges.
- B. Leak at gasket B results in a steady flow of air to atmosphere while in HIGH RANGE.
- C. Leak at O-ring C results in a slow shift to LOW RANGE; pressurizing of transmission case.

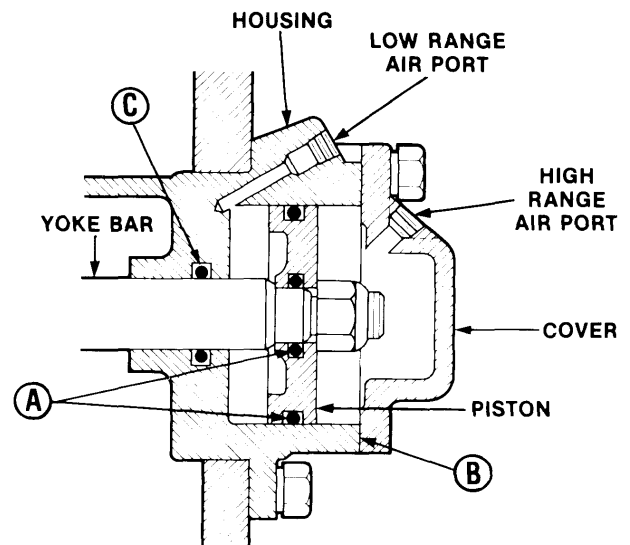

Cut 7420 4/84

Range Cylinder Assembly

AIR SYSTEM

AIR FILTER/REGULATOR ASSEMBLY

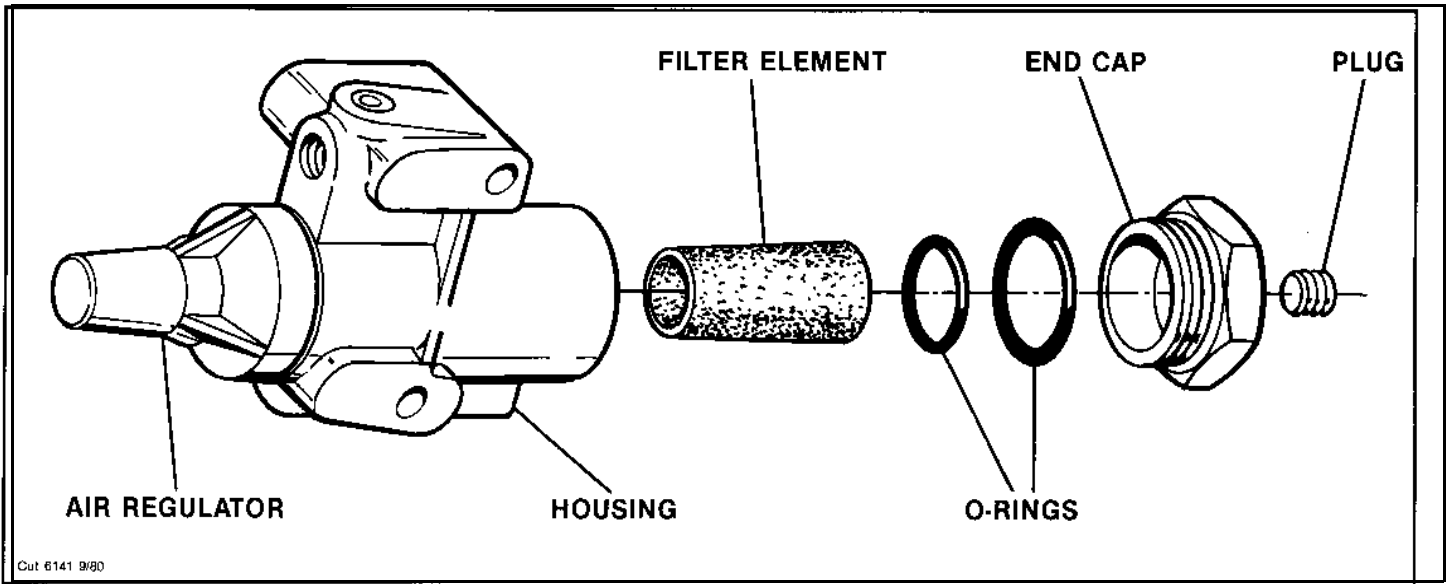

The air filter contains a replaceable filter element which can be removed by turning out the end cap. This element should be cleaned at each oil change, or more often under high humidity conditions. Replace if necessary.

SLAVE VALVES

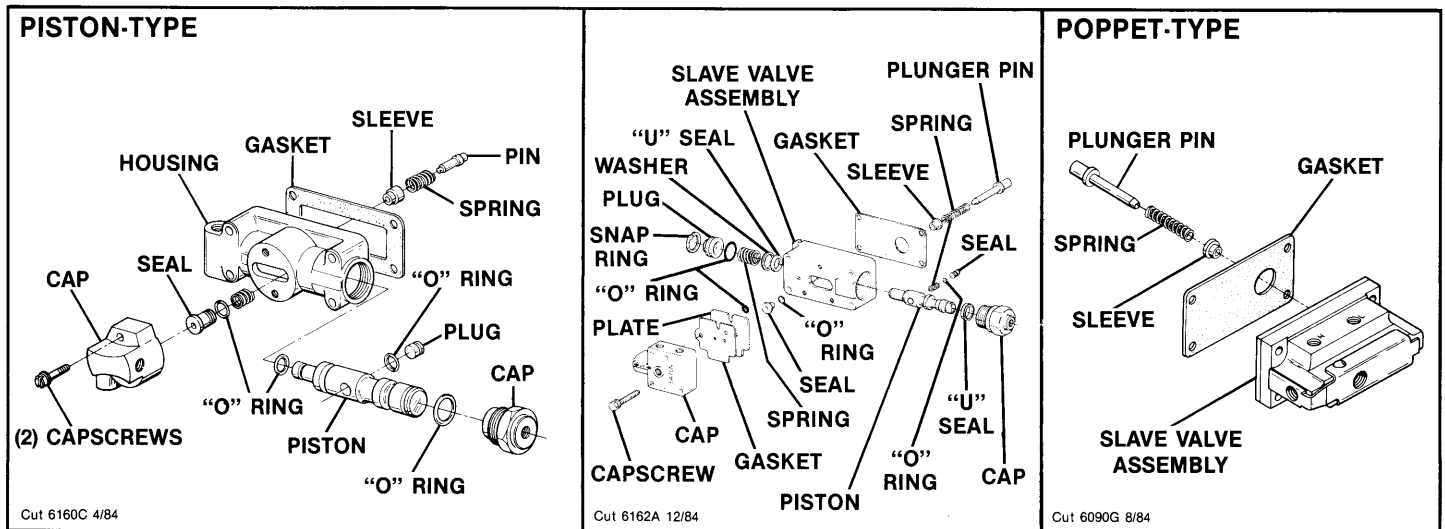

Refer to the drawing for disassembly and reassembly of the piston-type slave valve assemblies. **Should the poppet-type slave valve assembly prove to be defective, replace the complete assembly, as it is non-serviceable.** The actuating components used with these valve assemblies are non-interchangeable. Failure to use the correct plunger pin, spring, and alignment sleeve during installation on the transmission will cause hard shifting in Low Range gears.

AIR SYSTEM

RANGE CONTROL VALVE A-3546

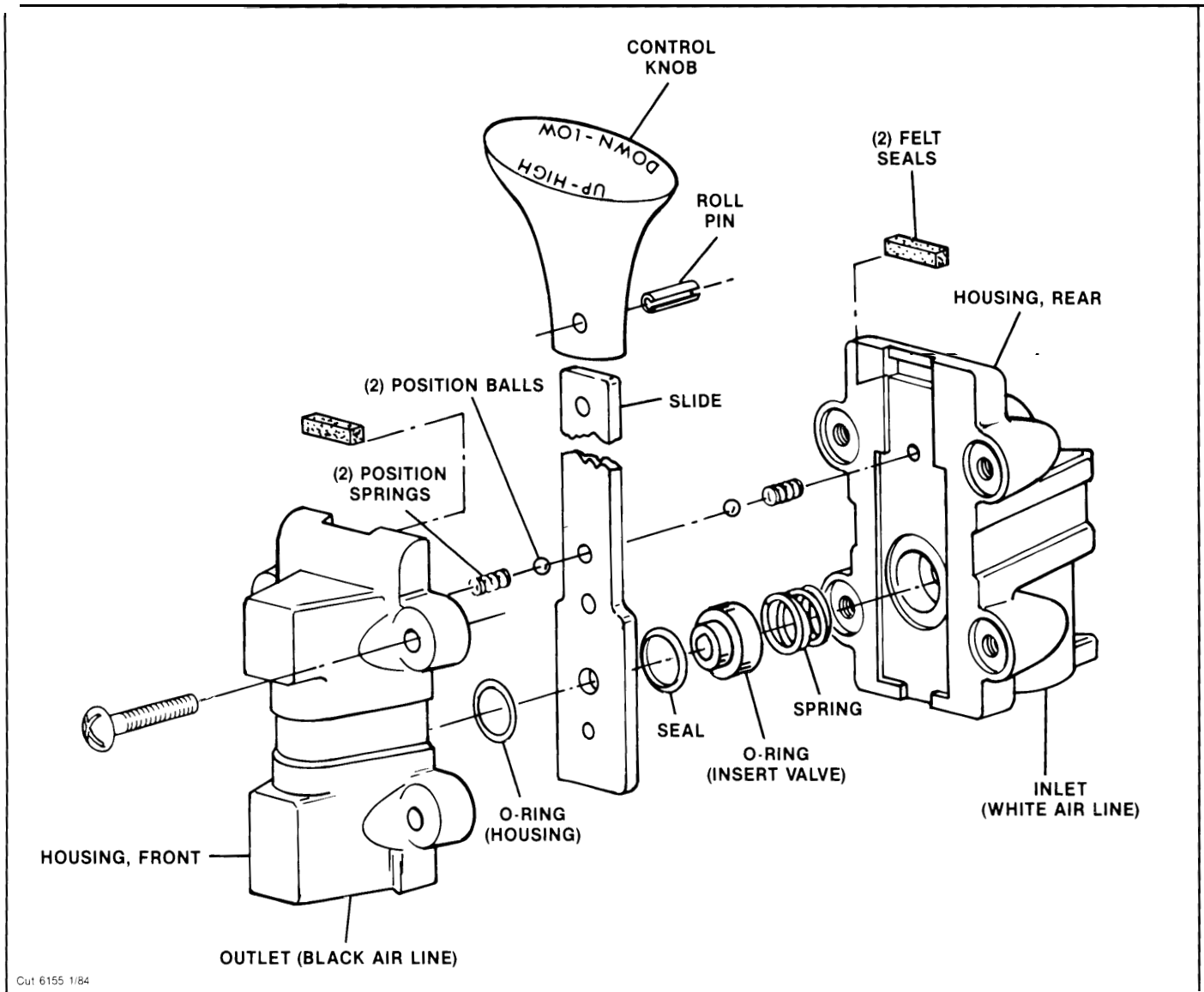

Removal and Disassembly

1. Disconnect the air lines and loosen clamp securing the valve to gear shift lever. Remove valve.
2. Remove the four screws to separate the front and rear housings and remove the slide and two sets of position springs and balls.
3. Remove the seal, insert valve O-ring and spring from rear housing.
4. If necessary, remove the two felt seals. Punch out the roll pin to remove the control knob from slide.

Reassembly and Installation

1. Refer to the drawing for proper reassembly. Use a **VERY SMALL** amount of silicone lubricant on the O-rings to avoid clogging ports. A small amount of grease on the position springs and balls will help to hold them in place during reassembly.
2. Install the air lines with their sheathing and O-rings on the gear shift lever.
3. Secure the valve on gear shift lever with mounting clamp. The control knob should face to the front and be approximately 6" below the centerline of ball grip.
4. Attach the air lines.

AIR SYSTEM

RANGE CONTROL VALVE A-5010

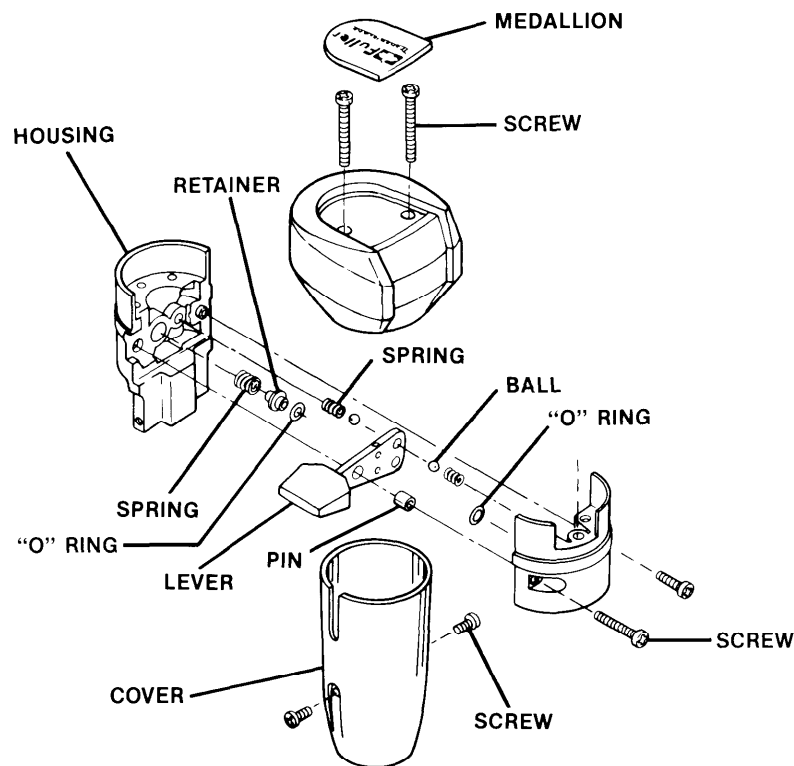

Cut 6146A 2/84

Removal and Disassembly

1. Remove two screws holding bottom cover to valve and slide cover down gearshift lever to expose air line fittings. Disconnect air lines.
2. Loosen jam nut and turn control valve from gear shift lever.
3. Pry medallion from recess in top cover.
4. Turn out the two screws to remove the top cover from valve housing.
5. Turn out the two screws in side of valve housing to separate the housing.
6. Remove the Range Preelection Lever from left housing and the position balls and guide from lever.
7. If necessary, remove spring and O-ring from bores in left housing.
8. If necessary, remove springs, O-ring and sleeve from bores in right housing.

Reassembly and Installation

1. Refer to the drawing for proper reassembly. Use a VERY SMALL amount of silicone lubricant on the O-rings to avoid clogging ports. A small amount of grease on the position springs and balls will help to hold them in place during reassembly.
2. Reinstall control valve on gear shift lever and tighten jam nut.
3. Attach air lines and reinstall bottom cover.

7L: 8: 9: and 10 Speed (2-Speed Auxiliary)

Range—LO

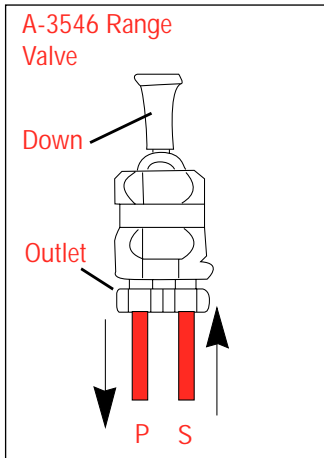

OR

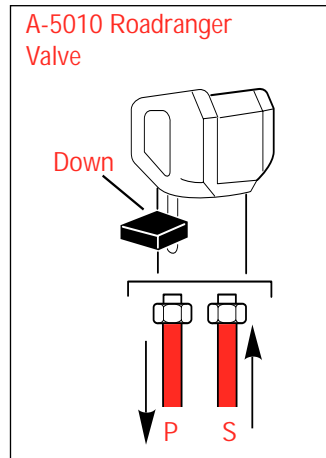

Slave Valve Identification

A-4688 Valve

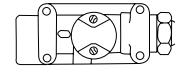

A-5000 Valve

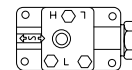

19470 Valve

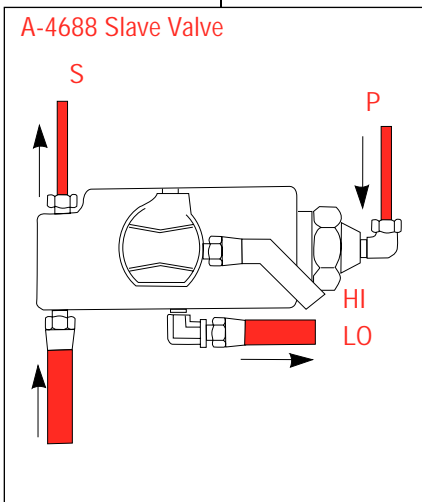
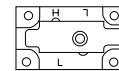

OR

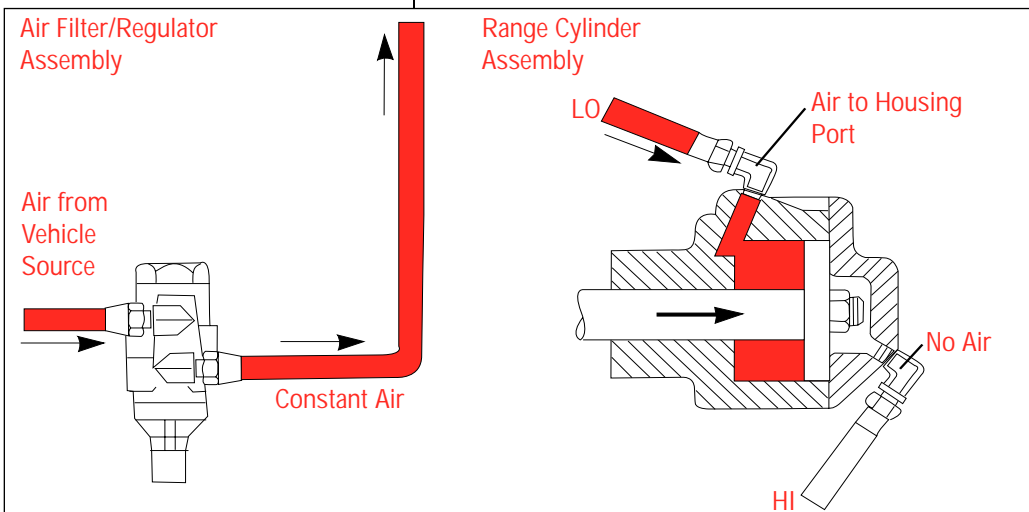
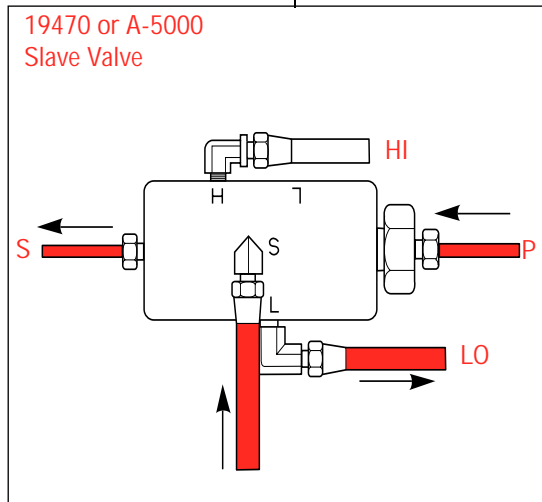

Schematic

For all questions concerning removal and replacement, refer to Eaton Service and Parts Literature.

7L: 8: 9: and 10 Speed (2-Speed Auxiliary)

Range—HI

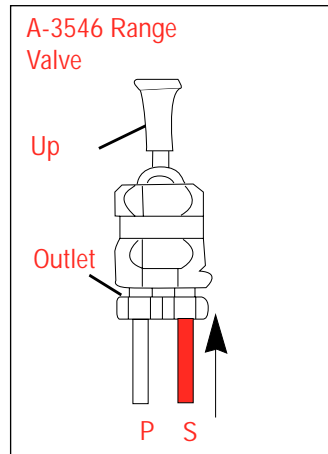

OR

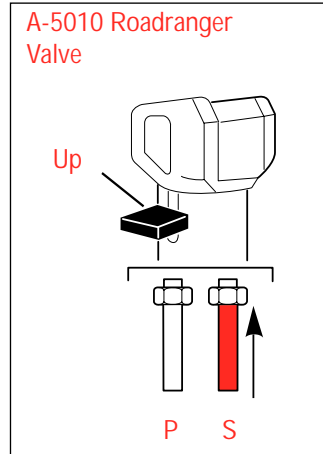

Slave Valve Identification

A-4688 Valve

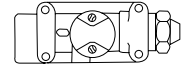

A-5000 Valve

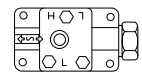

19470 Valve

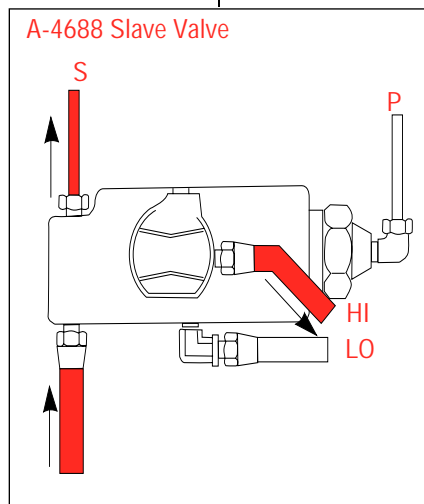
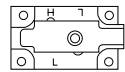

OR

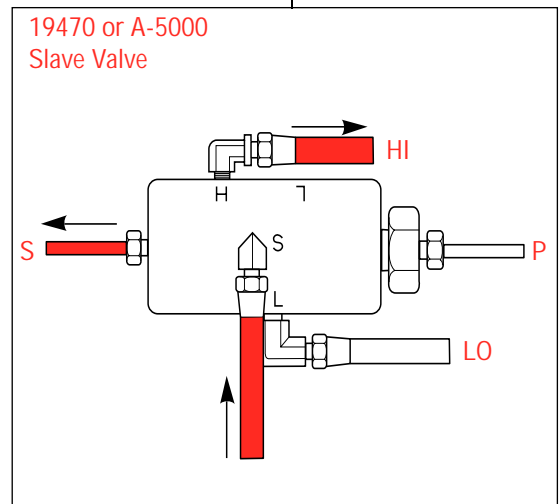

Schematic

For all questions concerning removal and replacement, refer to Eaton Service and Parts Literature.

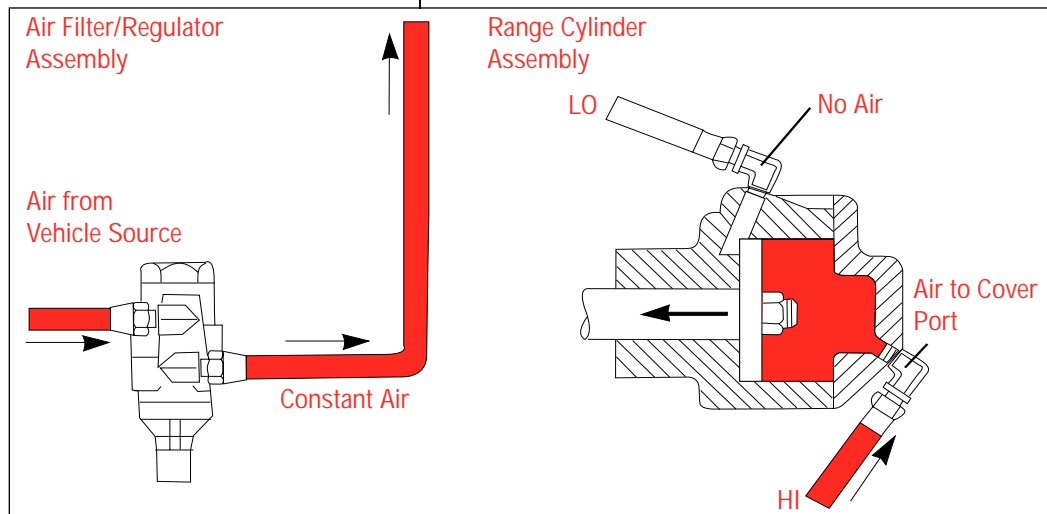

DISASSEMBLY AND REASSEMBLY SHIFTING CONTROLS

AIR SYSTEM

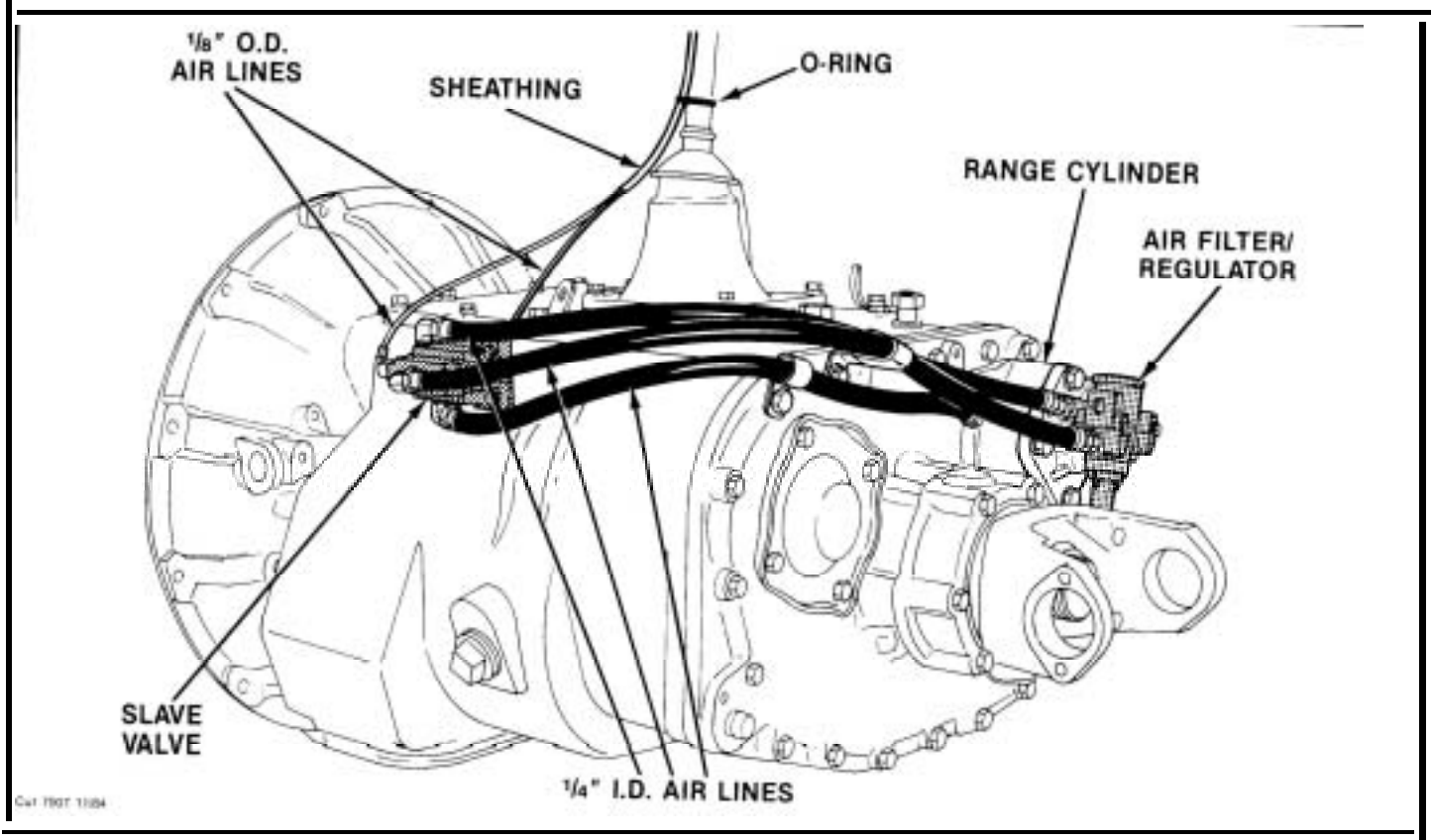

RANGE
CONTROL
VALVE
A-5010
(2) PORT
CONNECTORS

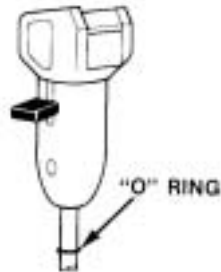

RANGE
CONTROL
VALVE
A-3546
(2) PORT
CONNECTORS



A. Removal of Control Valve

NOTE: For removal and disassembly of models also equipped with the Countershaft Brake Control, see Page 106.

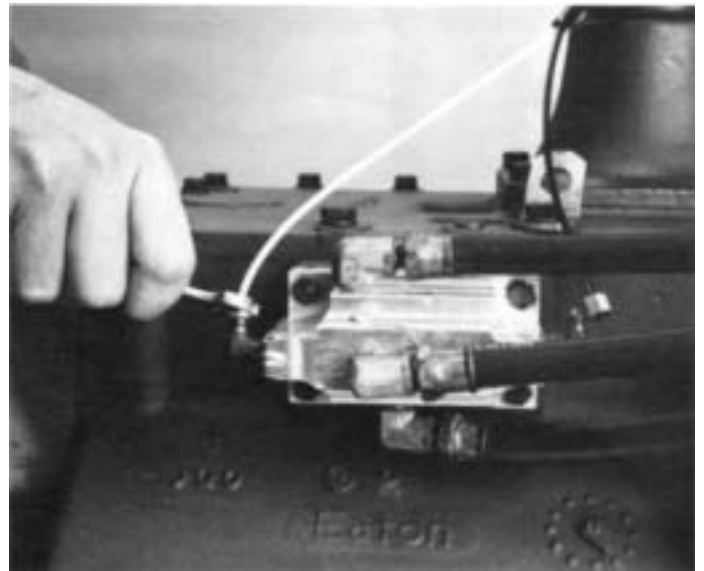

1. Disconnect two 1/8" O.D. air lines at the "S" or Supply Port and the "P" or End Port of slave valve on transmission case.

DISASSEMBLY AND REASSEMBLY SHIFTING CONTROLS

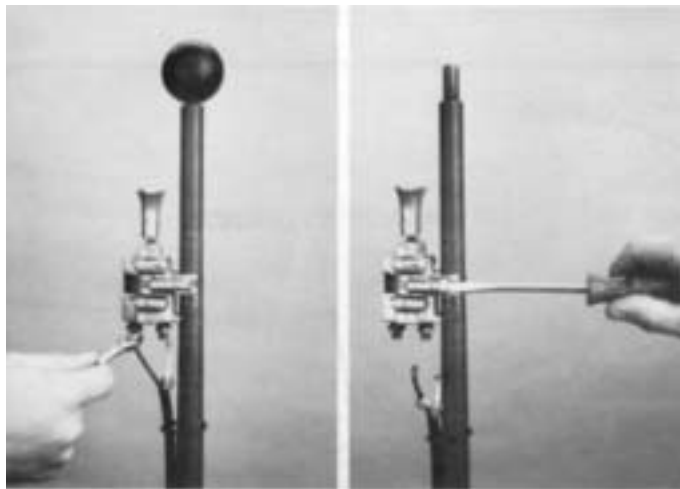

3. Disconnect two 1/8" O.D. air lines at Range Control Valve of models so equipped (left). Remove ball grip, loosen valve mounting clamp and remove valve, mounting clamp, air lines, sheathing and O-rings from gear shift lever (right).
NOTE: For disassembly and reassembly of Range Control Valve, see Page 23.



5. Slide cover down shift lever to expose valve ports and disconnect two 1/8" O.D. air lines at valve.



4. For models equipped with an A-5010 Valve, turn out two mounting screws in valve cover.



6. Loosen jam nut and turn the A-5010 Valve and nut from gear shift lever. Remove valve cover, air lines, sheathing and O-rings from lever.
NOTE: For disassembly and reassembly of A-5010 Valve, see Page 24.

DISASSEMBLY AND REASSEMBLY SHIFTING CONTROLS

B. Removal of Air Filter Regulator Assembly

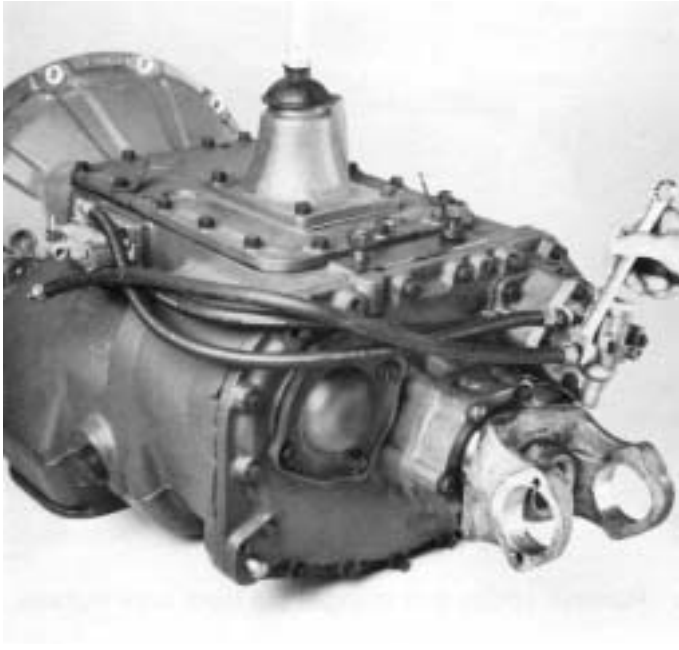

1. Disconnect and remove 1/4" I.D. air line between the slave valve and air filter/regulator assembly.

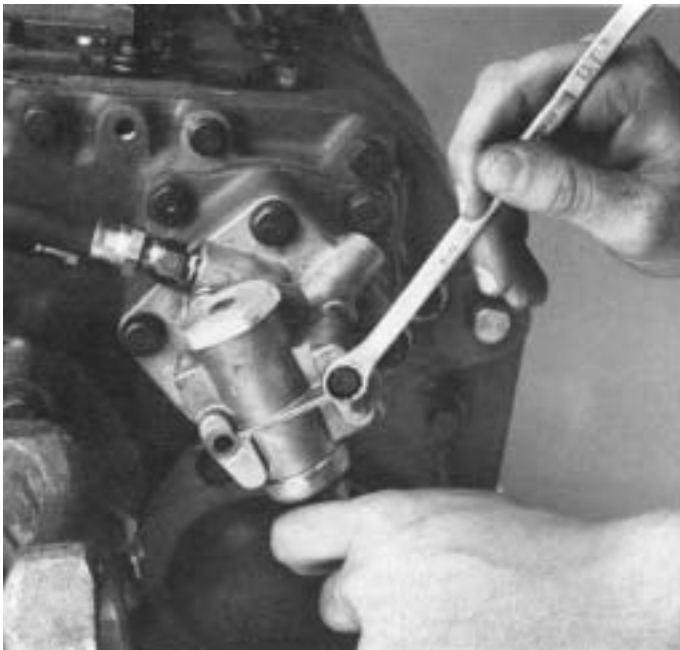

2. Turn out capscrews and remove air filter/regulator assembly.
NOTE: For disassembly and reassembly of Air Filter/Regulator Assembly, see Page 22.

C. Removal of Slave Valve 19470 Slave Valve shown. For other slave valve combinations see Air System Schematics page 25.



1. Disconnect and remove 1/4" I.D. air line between the slave valve and High Range Port in housing of range cylinder.



2. Disconnect and remove 1/4" I.D. air line between the slave valve and Low Range Port in cover of range cylinder.

DISASSEMBLY AND REASSEMBLY SHIFTING CONTROLS

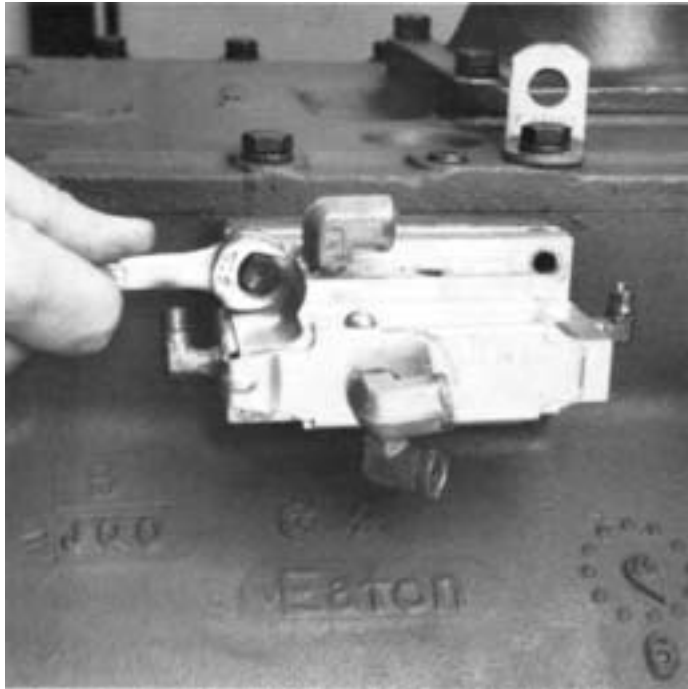

3. Turn out four retaining capscrews and remove slave valve from transmission.



5. Remove spring and plunger pin from bore in case.

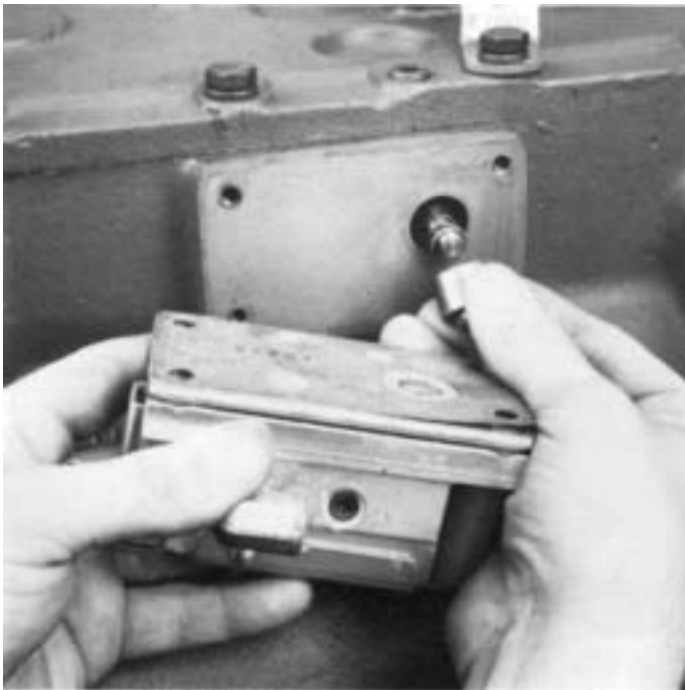

4. Remove hat-type alignment sleeve from bore in slave valve.

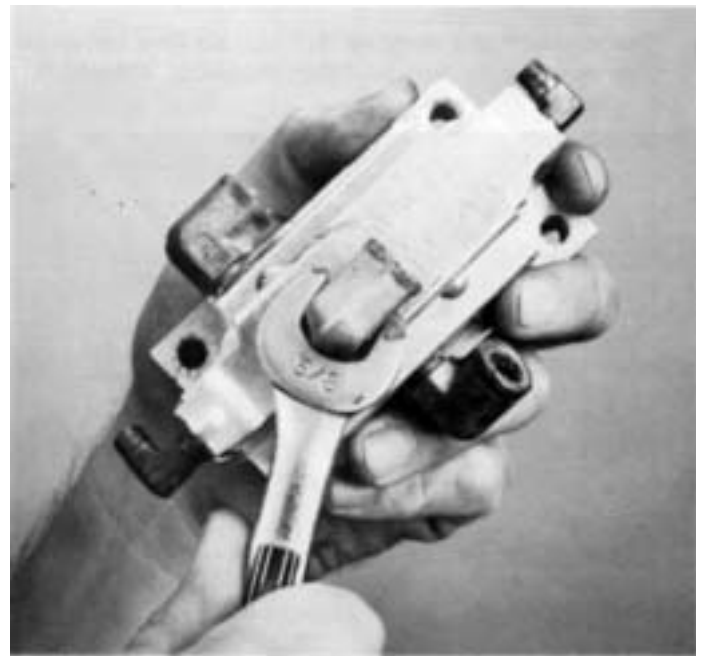

6. If necessary, remove air line fittings from slave valve.

NOTE: For disassembly and reassembly of piston-type Slave Valve Assembly ONLY, see Page 22.

DISASSEMBLY AND REASSEMBLY SHIFTING CONTROLS

GEAR SHIFT LEVER HOUSING ASSEMBLY

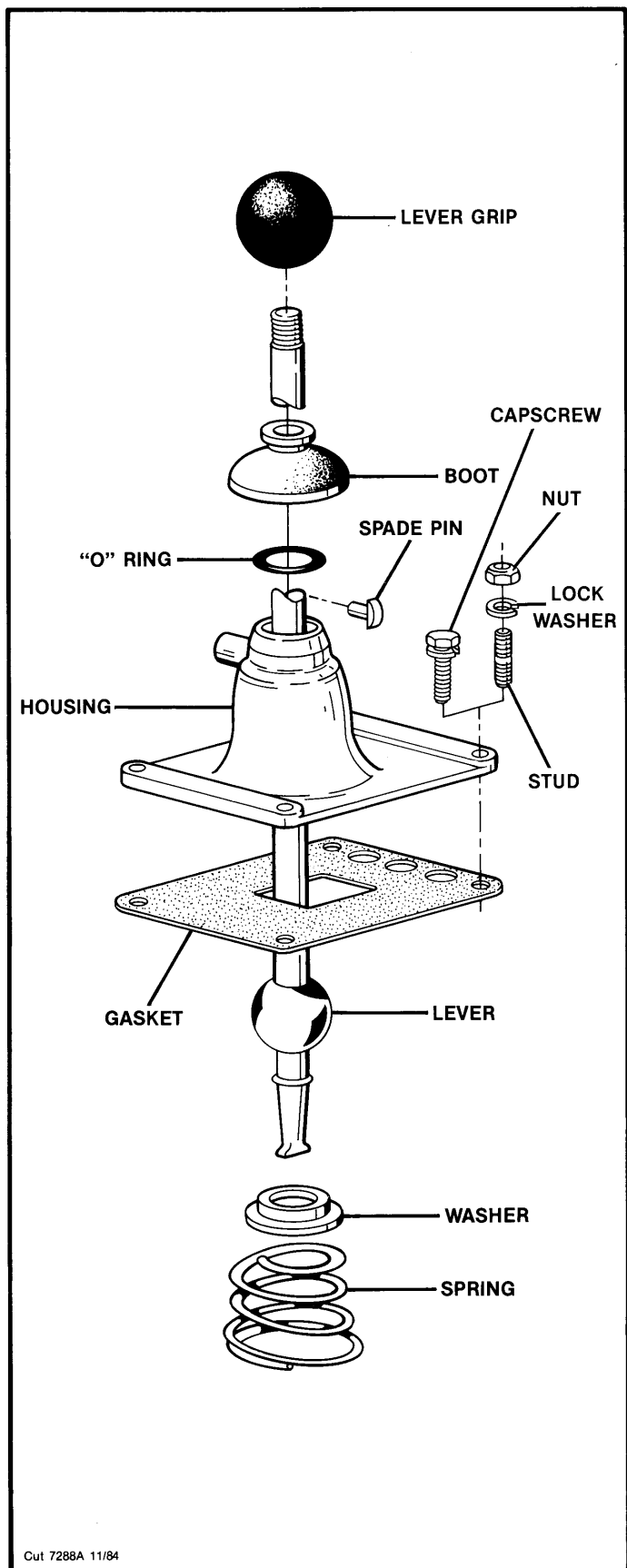

A. Removal and Disassembly



4-2

1. Turn out four cap screws, jar lightly to break gasket seal and remove gear shift lever housing from shift bar housing.

NOTE: Remote control housings are removed from shift bar housing in the same manner. For disassembly and reassembly of LRC Assemblies, see Illustrated Parts List No. P-541. For disassembly and reassembly of SRC Assemblies, see Illustrated Parts List No. P-515.

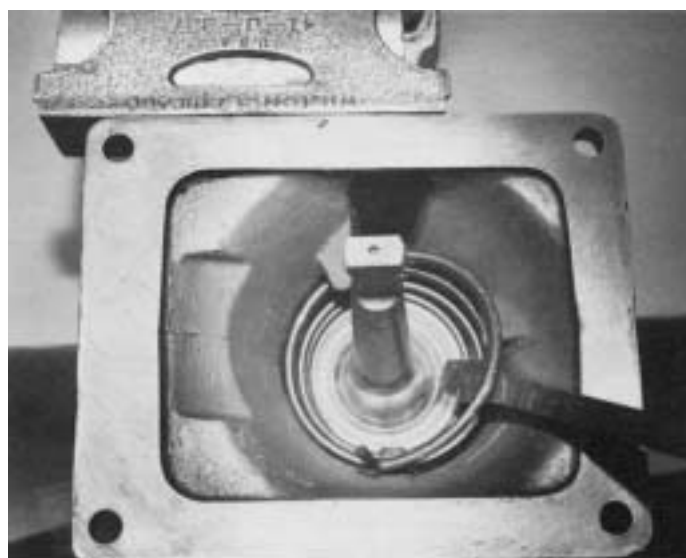

2. Remove boot from gear shift lever and secure assembly in vise with bottom of housing up. Use a large screwdriver to twist between spring and housing, forcing spring from under lugs in housing. Do one coil at a time.

DISASSEMBLY AND REASSEMBLY SHIFTING CONTROLS

B. Reassembly of Gear Shift Lever Housing Assembly



3. Remove tension spring, washer and gear shift lever from housing.



1. With gear shift lever housing secured in vise as during disassembly, install spade pin in bore of housing tower. If previously removed, install O-ring in tower groove.



4. Remove spade pin from bore in housing tower. If necessary, remove the O-ring from groove inside tower.



2. Position gear shift lever in housing with spade pin in lever ball slot and install tension spring washer over ball, dished-side up.

DISASSEMBLY AND REASSEMBLY SHIFTING CONTROLS



3. Install tension spring under lugs in housing, seating one coil at a time. Use of a spring driving tool is recommended.



4. Remove assembly from vise and install rubber against housing.

DISASSEMBLY AND REASSEMBLY SHIFTING CONTROLS

SHIFT BAR HOUSING ASSEMBLY

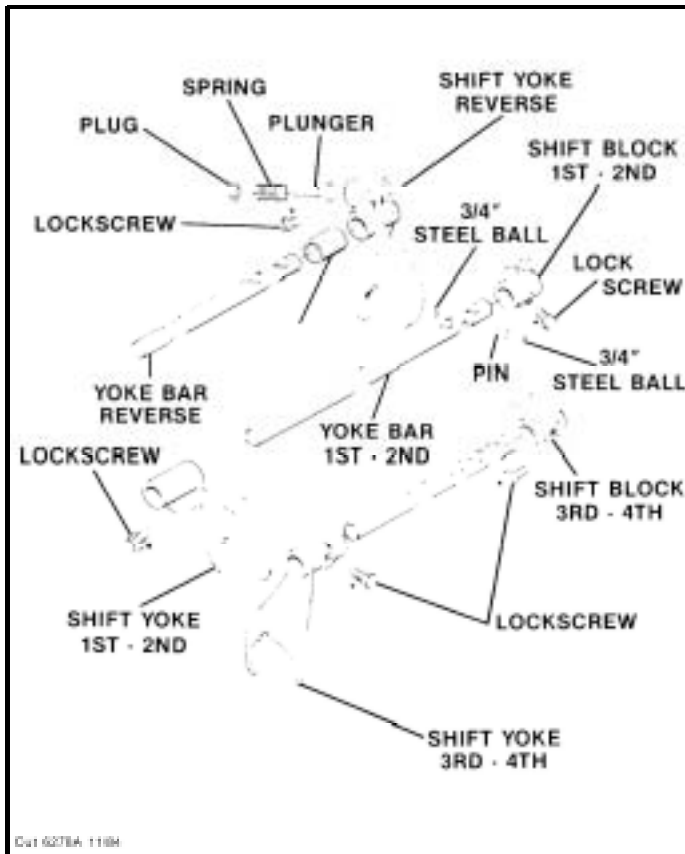

Cat 6278A, 1110H

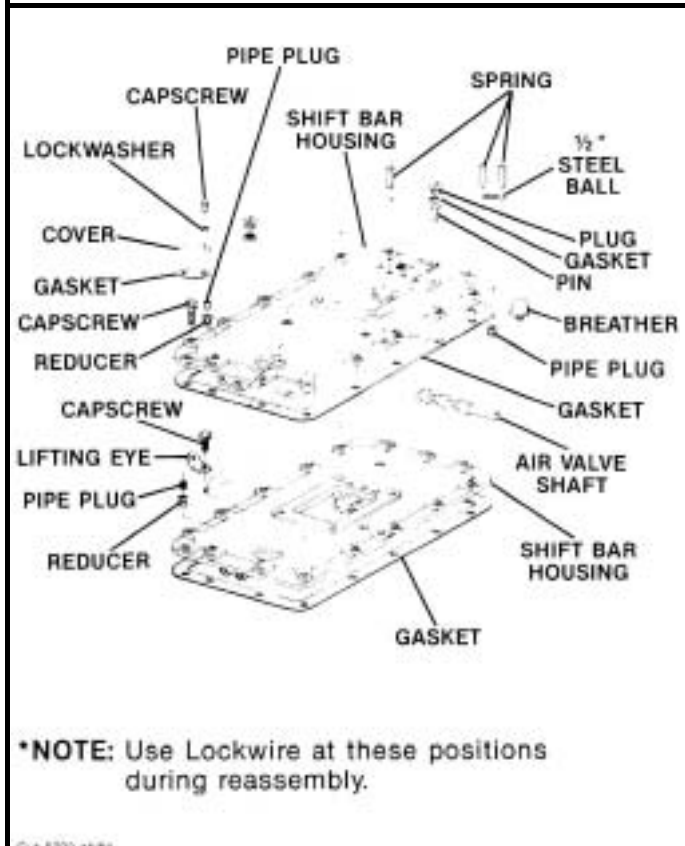

Cat 6278A, 1110H

A. Removal and Disassembly

NOTE: For models equipped with an Oil Pump and/or Cooler Assemblies, make sure to disconnect the lube line at fitting on shift bar housing prior to proceeding with the following instructions.

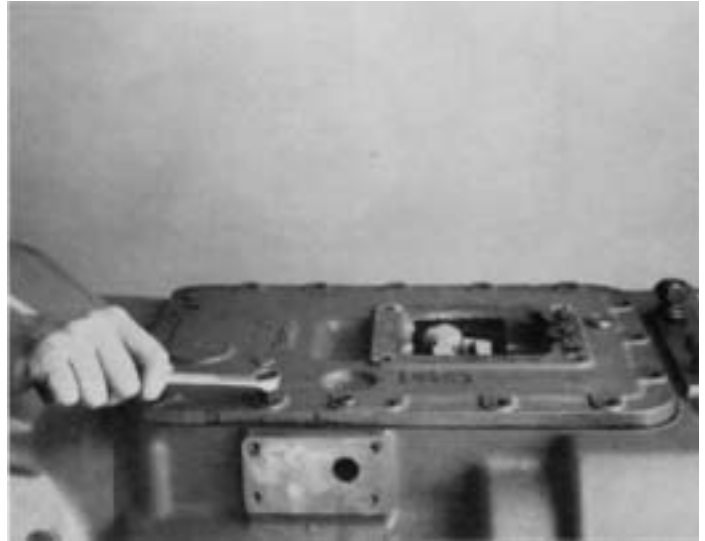

1. Turn out capscrews, jar to break gasket seal and lift shift bar housing from case.

NOTE: During disassembly, lay all parts on a clean bench in order of removal from housing to facilitate reassembly. Shift bars not being removed **MUST** be kept in the neutral position or interlock parts will lock bars. For disassembly and reassembly of "X" and "F" model assemblies, see Illustrated Parts List.

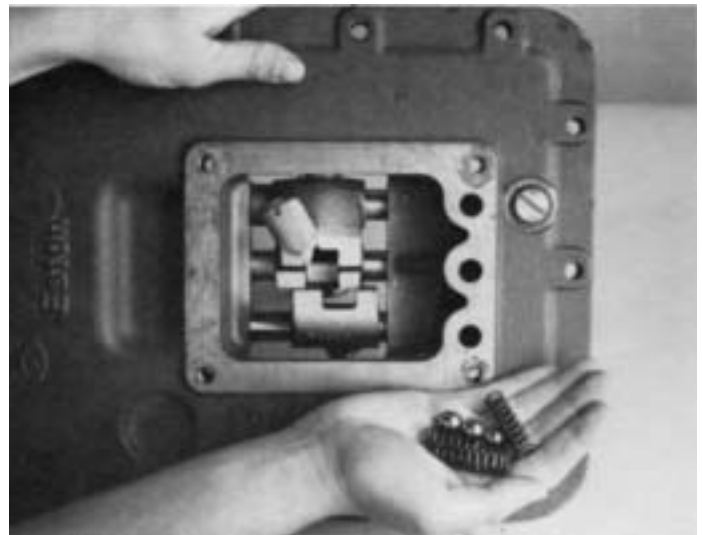

2. Tilt assembly and remove three tension springs and balls from housing.

DISASSEMBLY AND REASSEMBLY SHIFTING CONTROLS

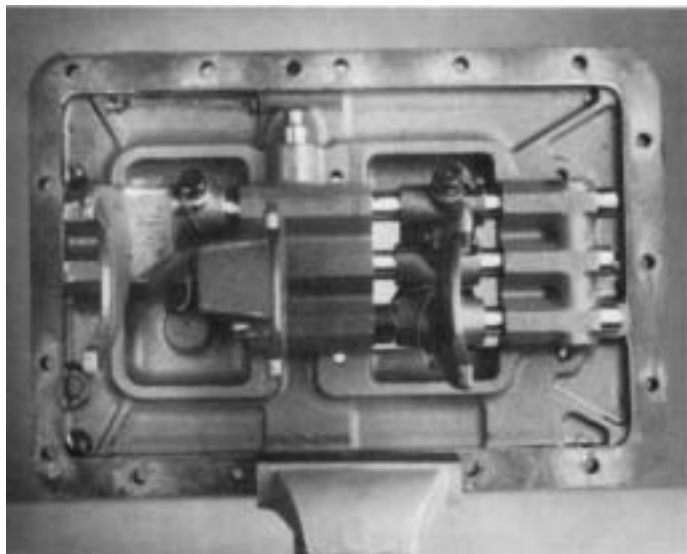

3. Mount assembly in a vise with plunger-side up and secure on housing flange. For models so equipped, cut lockwire and turn out the retaining capscrews to remove oil trough from housing.
NOTE: Starting with the upper shift bar, move all bars to the right and out bore of rear boss. Cut lockwire and remove lockscrews from each bar just prior to their removal from housing.

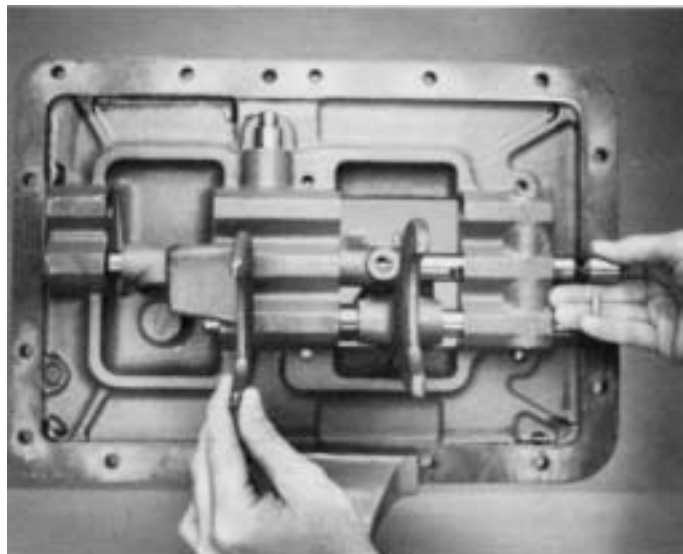

5. Move 1st-2nd speed shift bar to rear of housing, removing yoke and block from bar. As notch in bar clears rear boss, remove small interlock pin from bore at notch.

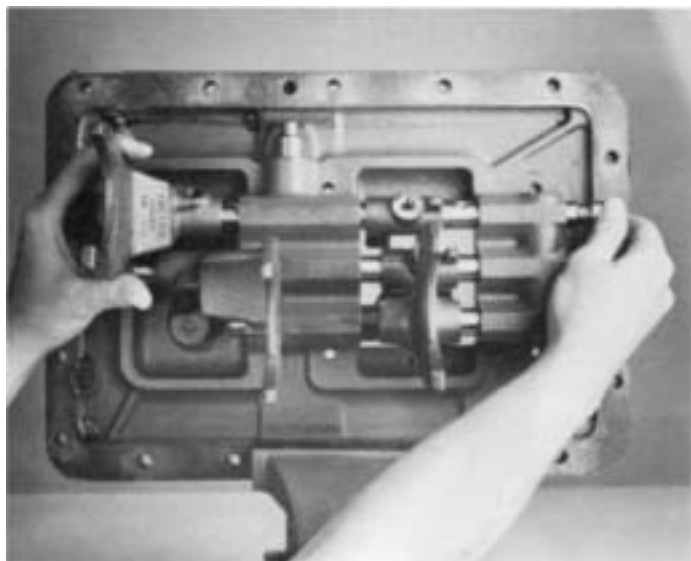

4. Move 3rd-4th speed shift bar to rear of housing, removing yoke and block from bar.

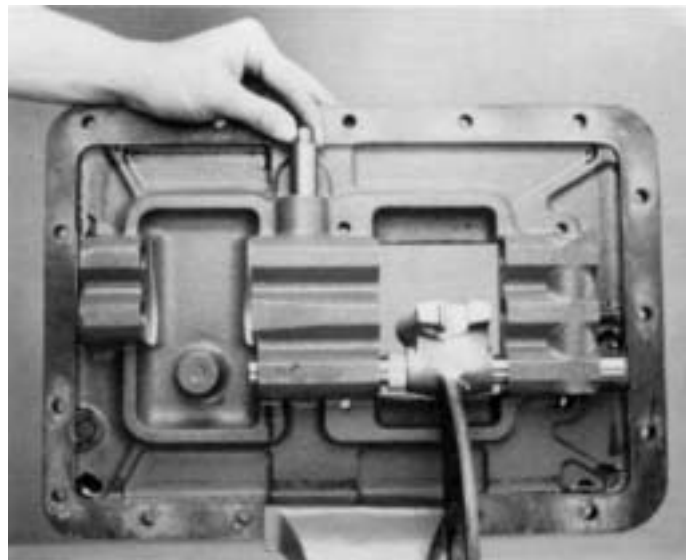

6. Remove actuating plunger from bore at top of center boss.

DISASSEMBLY AND REASSEMBLY SHIFTING CONTROLS

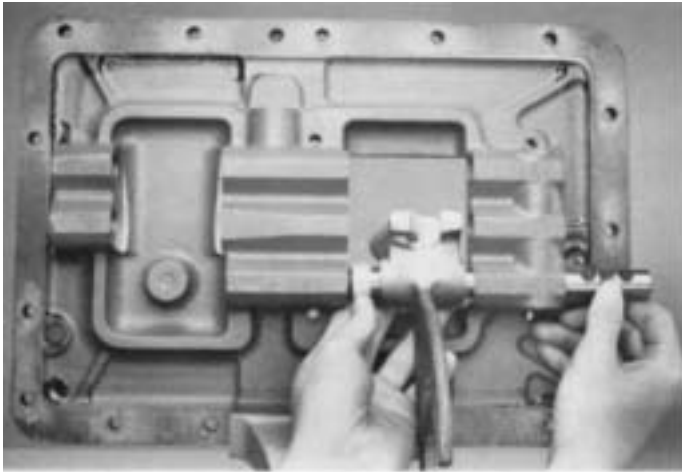

7. Move Reverse speed shift bar to rear of housing, removing yoke and spacer from bar.

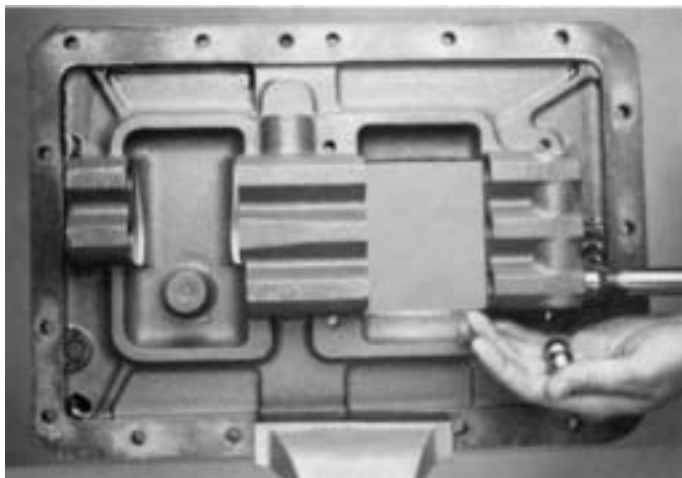

8. As shift bar is removed from housing, two 3/4" interlock balls will drop from bottom bore of rear boss.



9. If necessary, remove plug, spring and plunger from bore in Reverse shift yoke.

B. Reassembly of Shift Bar Housing Assembly



1. If previously removed, install plunger in Reverse shift yoke, making sure plunger is fully seated in bore at yoke slot.



2. Install spring in bore of yoke and onto shank of plunger.

DISASSEMBLY AND REASSEMBLY SHIFTING CONTROLS

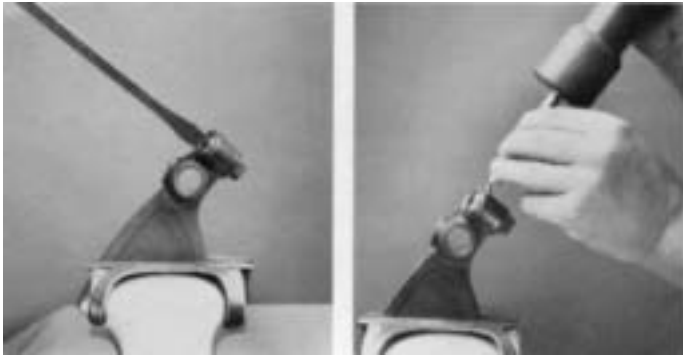

3. Install plug and tighten to compress spring (left). Back plug out 1 - 1 1/2 turns and stake plug through small hole in yoke (right).

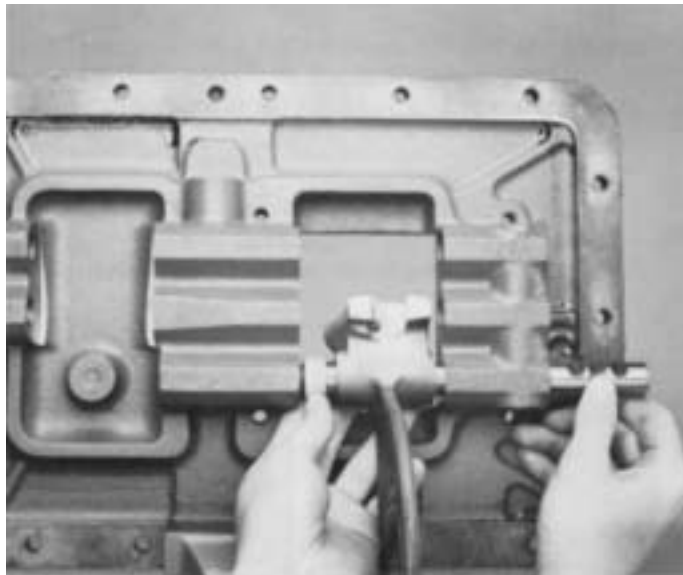

4. With shift bar housing secured in vise as shown, hold notched-end of Reverse shift bar and install in lower bore of housing bosses, positioning spacer and yoke on bar between the bosses. Install yoke lockscrew, torque to 35-45 lbs./ft. and wire securely.
NOTE: Keep bars in neutral position during installation. DO NOT EXCEED recommended torque ratings for yoke lockscrews.

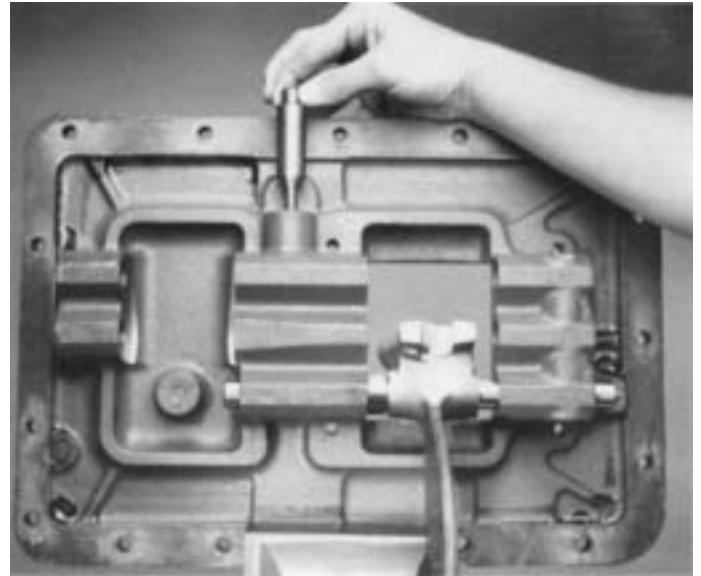

5. Install actuating plunger in bore at top of center boss as shown.

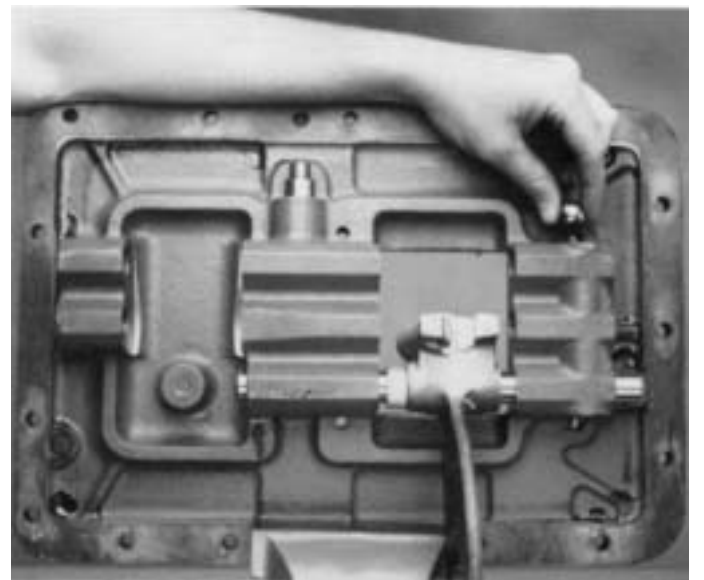

6. Install one 3/4" interlock ball in bore at top of rear boss.

DISASSEMBLY AND REASSEMBLY SHIFTING CONTROLS

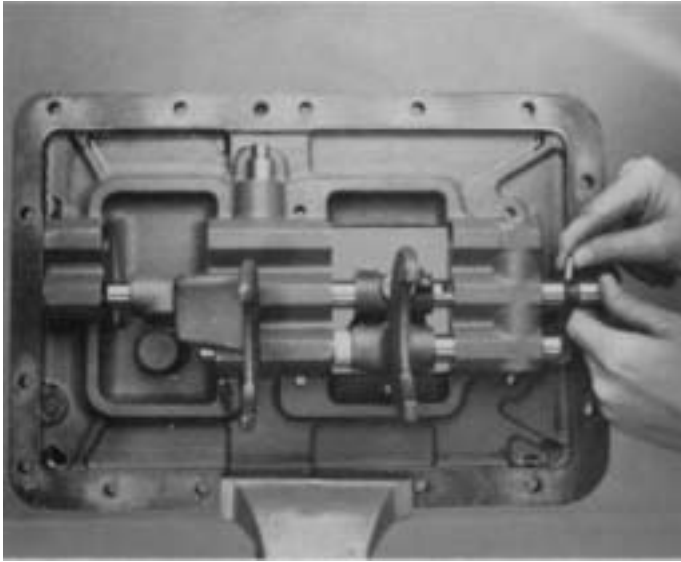

7. Install 1st-2nd speed shift bar in middle bore, positioning the shift block and yoke on bar as shown. Just prior to pushing notched end of bar in boss, install the interlock pin VERTICALLY in bore at neutral notch. Install the block and yoke lock screws, torque to 35-45 lbs./ft. and wire securely.

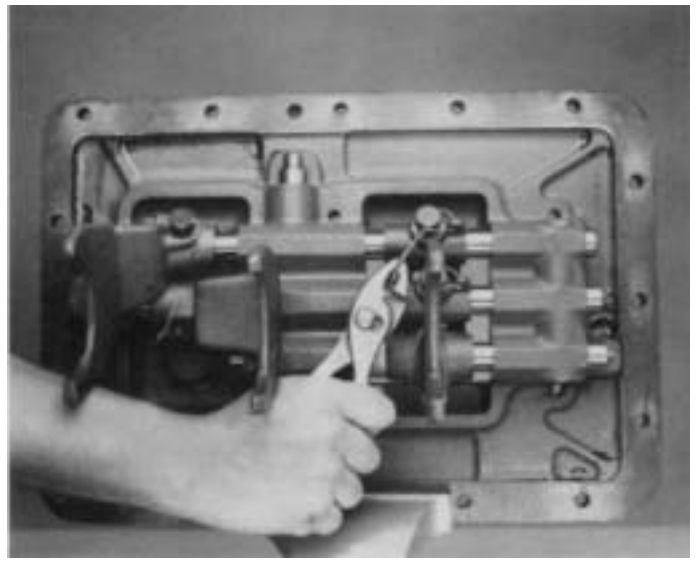

9. Install the 3rd-4th speed shift bar in upper bore, positioning the shift block and yoke as shown. Install the block and yoke lock screws, torque to 35-45 lbs./ft. and wire securely.

10. For models so equipped, install the oil trough on housing. Tighten capscrews and wire securely.

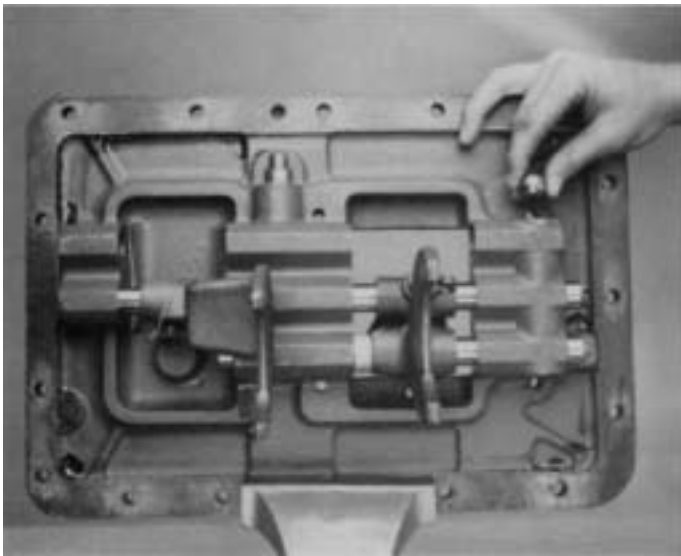

8. Install second 3/4" interlock ball in bore.

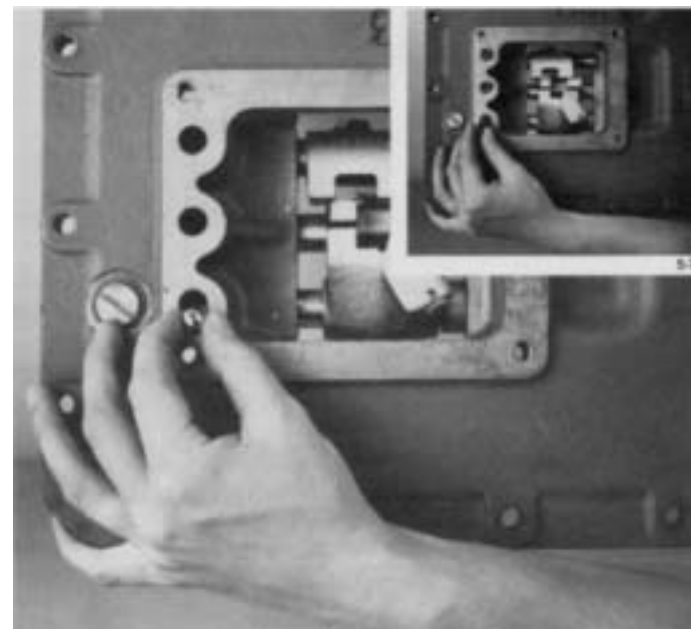

11. Remove assembly from vise and install three tension balls, one in each bore and three tension springs, one over each ball in housing bores (inset).

REMOVAL-COMPANION FLANGE, AUXILIARY SECTION AND CLUTCH HOUSING

COMPANION FLANGE, AUXILIARY SECTION AND CLUTCH HOUSING

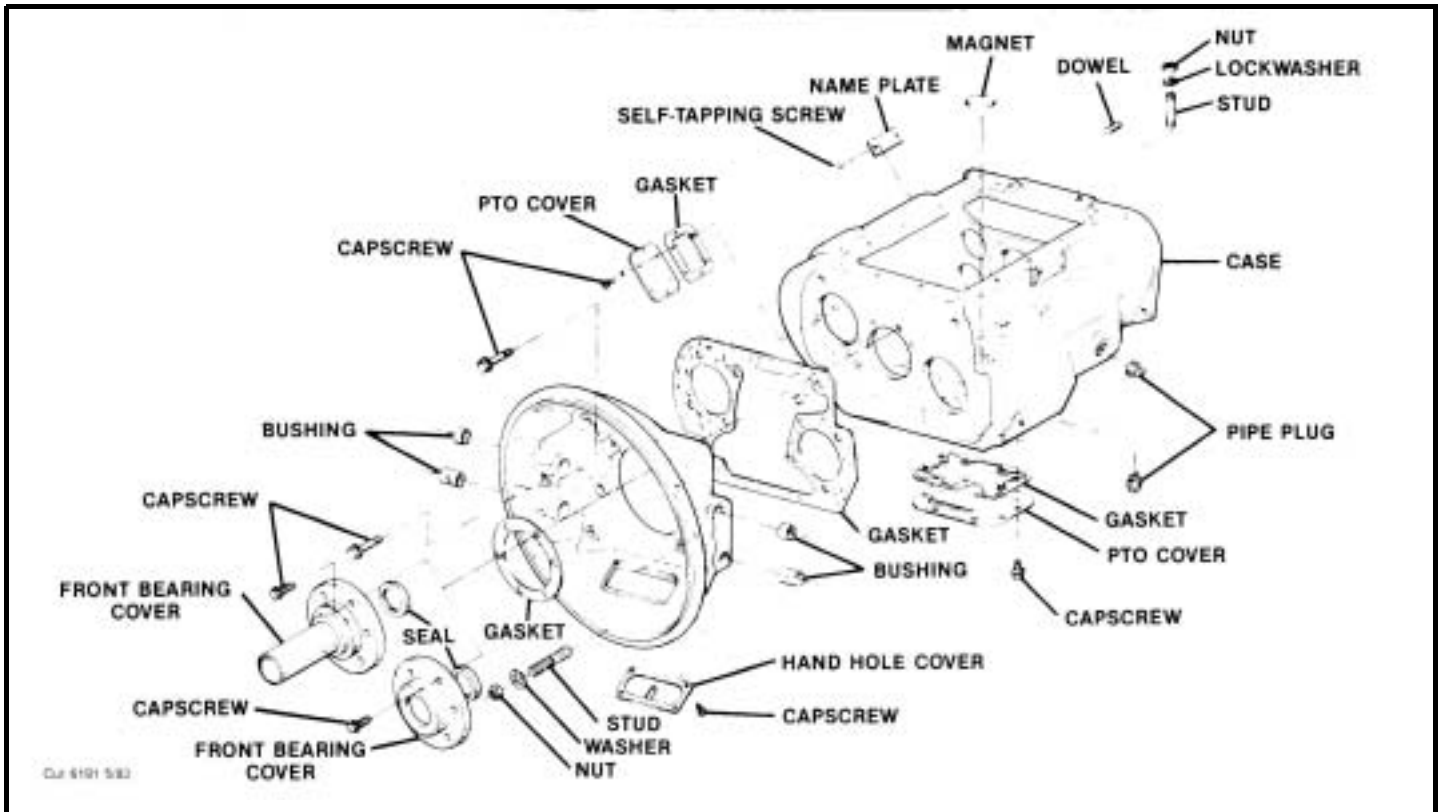

A. Removal of Universal Joint Companion Flange or Yoke

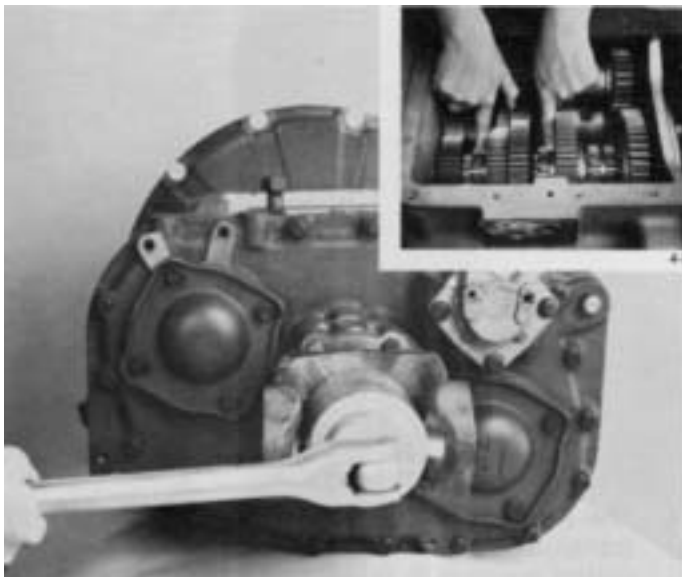

1. Lock transmission by engaging two mainshaft gears with sliding clutches (inset). Use a large breaker bar to turn nut from output shaft and remove washer if so equipped.



2. Pull companion flange or yoke from splines of output shaft. Remove speedometer drive gear or replacement spacer from hub of flange/yoke or from inside rear bearing cover remaining on output shaft.

REMOVAL-COMPANION FLANGE, AUXILIARY SECTION AND CLUTCH HOUSING

B. Removal of Auxiliary Section

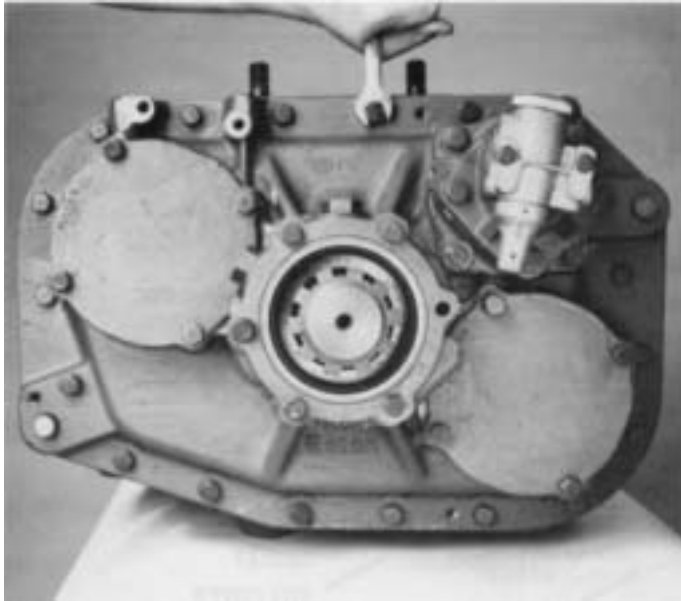

1. Turn out capscrews in auxiliary housing flange.

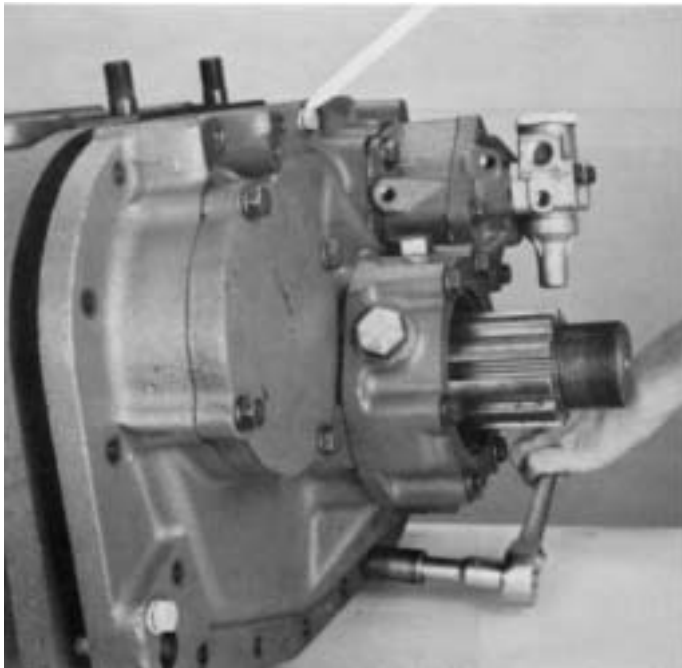

2. Insert three puller screws in tapped holes of housing flange. Tighten evenly to move auxiliary section to rear and just far enough from front section to break gasket seal.



3. Remove puller screws and attach a chain hoist to auxiliary section. Move assembly to rear until free of front section and remove gasket.



4. The auxiliary section can also be removed with transmission set in vertical position. Block under clutch housing to prevent damage to input shaft, remove capscrews in housing flange and lift assembly evenly from front section.

REMOVAL-COMPANION FLANGE, AUXILIARY SECTION AND CLUTCH HOUSING

C. Removal of Clutch Housing

1. For models so equipped, remove the clutch release mechanism and/or clutch brake assembly. See OPTIONS page 104.

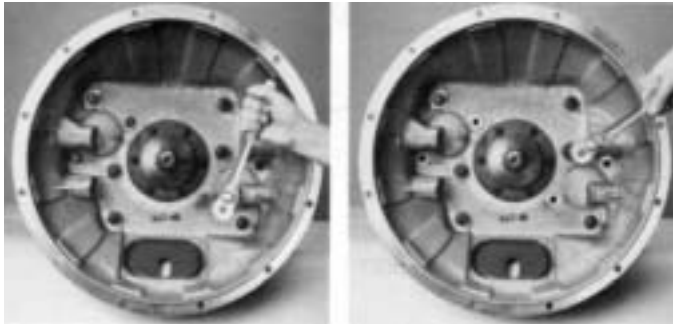

2. Turn out and remove four capscrews (left) and remove six nuts and lockwashers from studs (right) securing the clutch housing to transmission case.

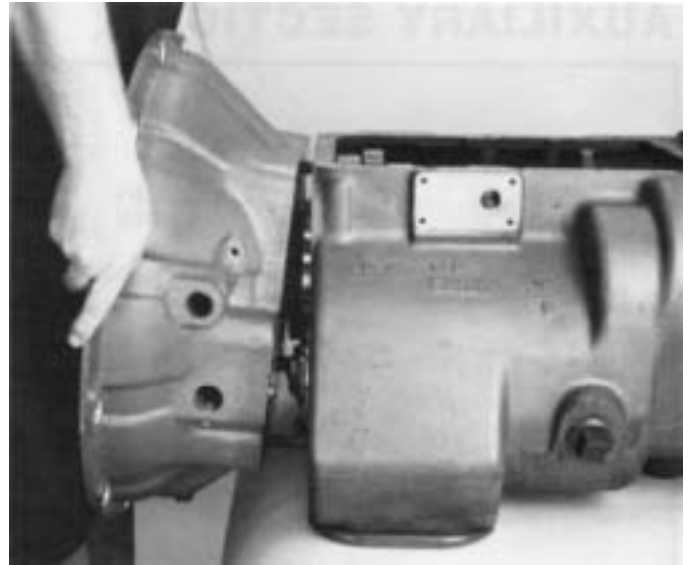

3. Jar clutch housing with a rubber mallet to break gasket seal and pull from transmission case.

DISASSEMBLY-AUXILIARY SECTION

AUXILIARY SECTION

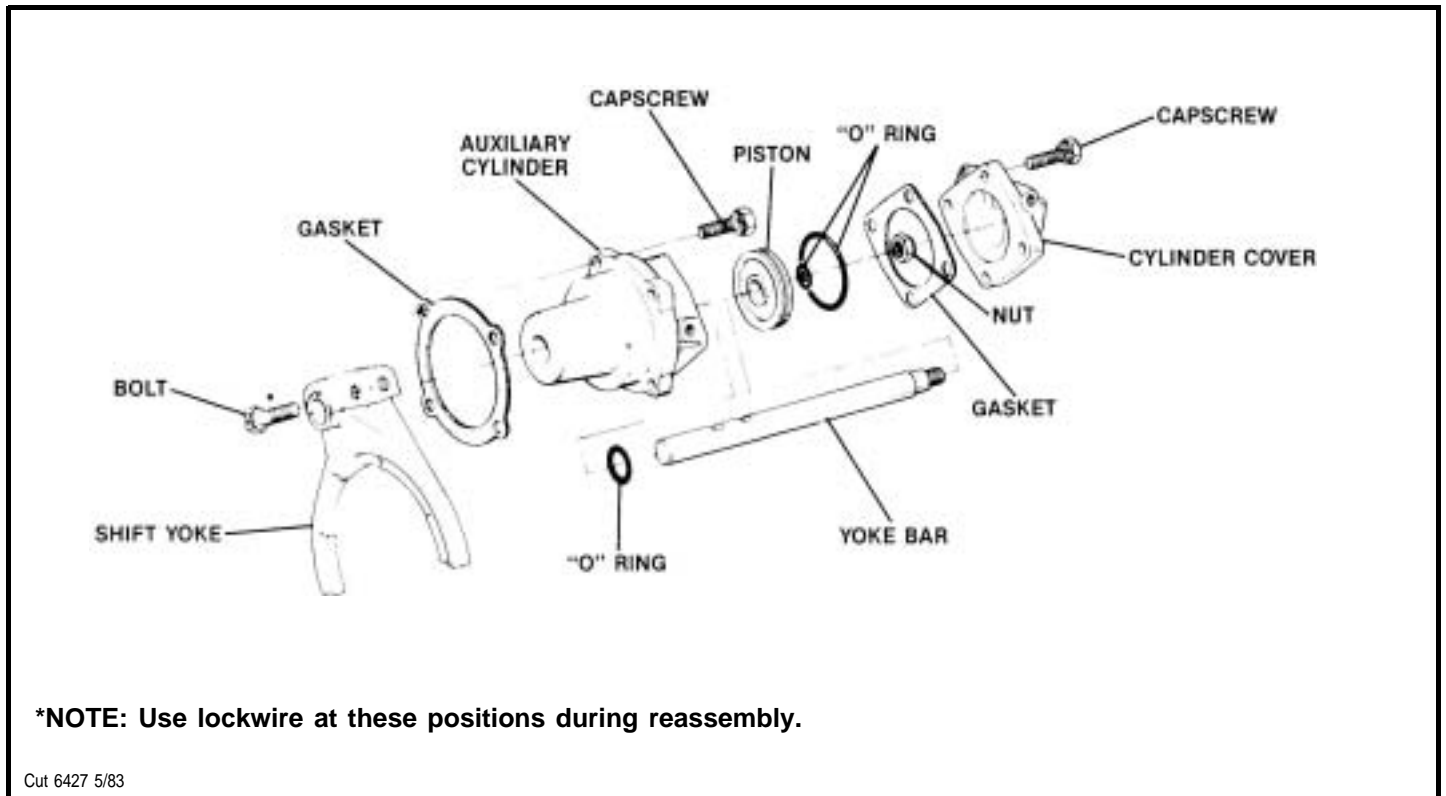

A. Removal and Disassembly of Range Cylinder Assembly

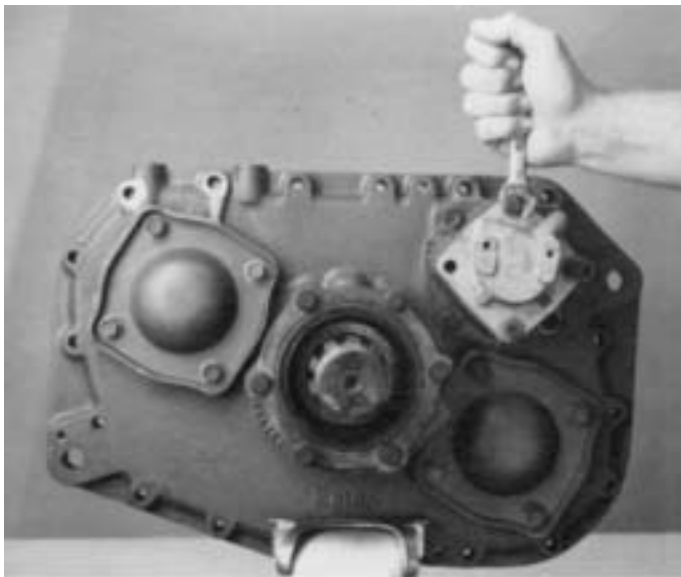

1. For ease of disassembly, mount auxiliary section upright in vise as shown. Turn out cap screws and remove range cylinder cover.

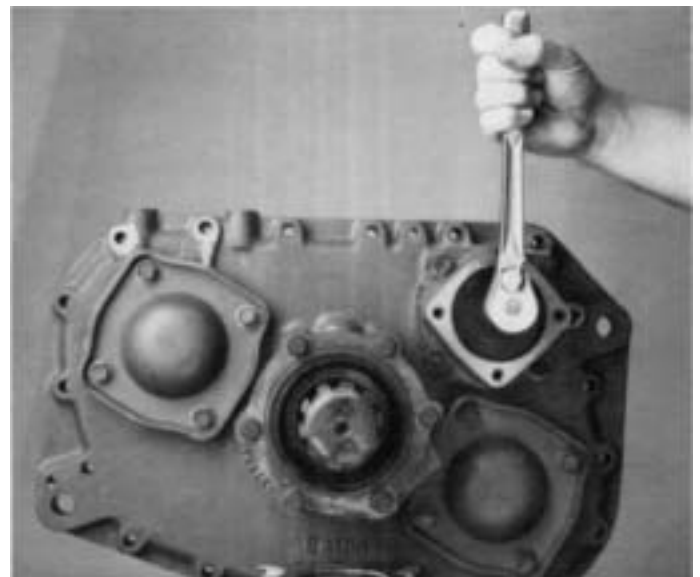

2. Remove nut from end of yoke bar.

DISASSEMBLY-AUXILIARY SECTION

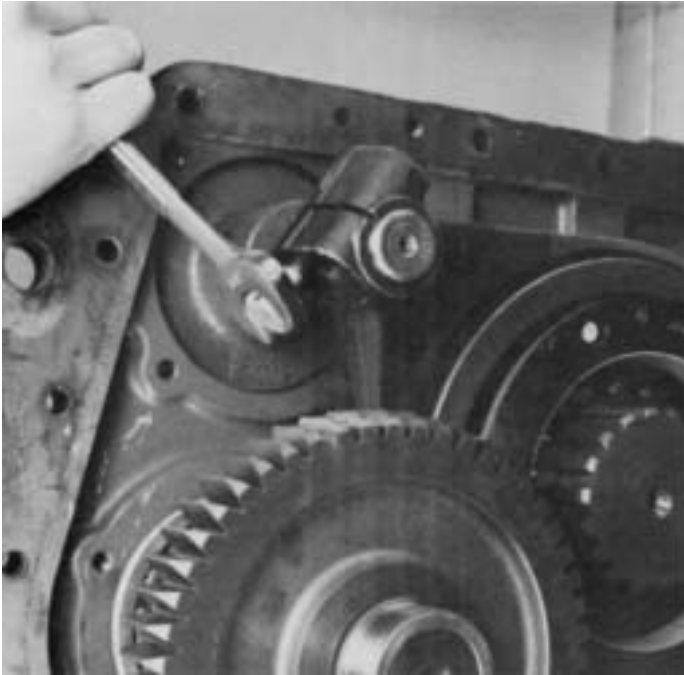

3. Cut lockwire and remove two yoke lockscrews.

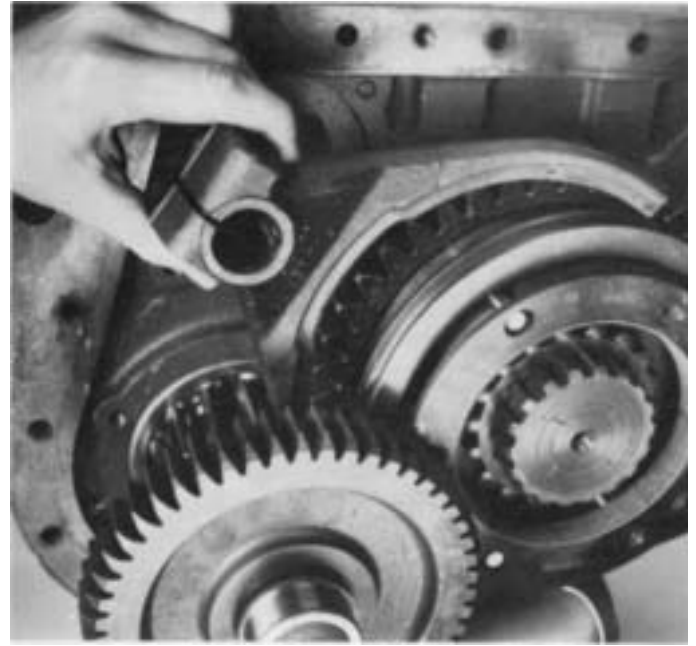

5. Remove range yoke from sliding clutch of syn-

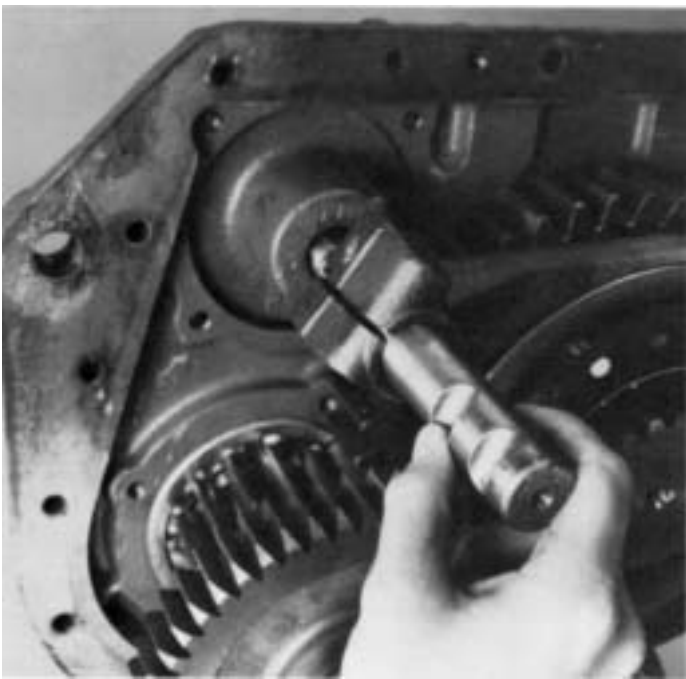

4. Pull yoke bar from bore of cylinder housing.

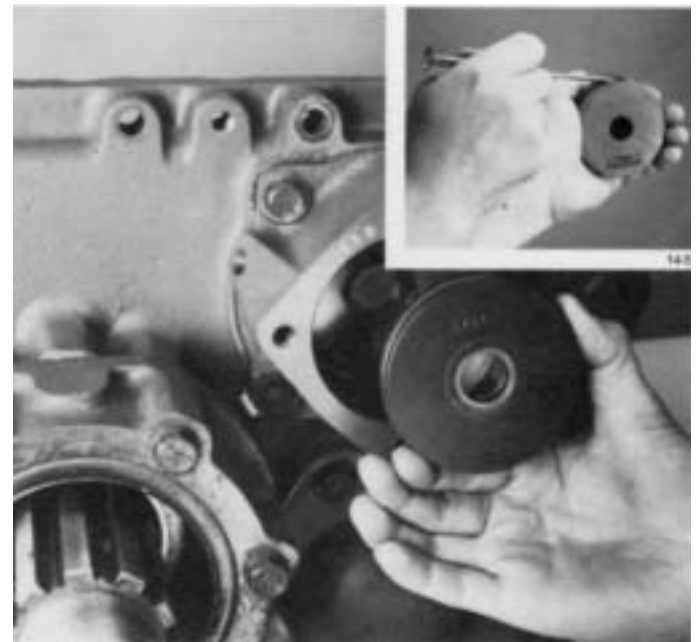

6. Remove range piston from cylinder bore.
If necessary, remove the O-rings from piston I.D.
and O.D. (inset).

DISASSEMBLY-AUXILIARY SECTION

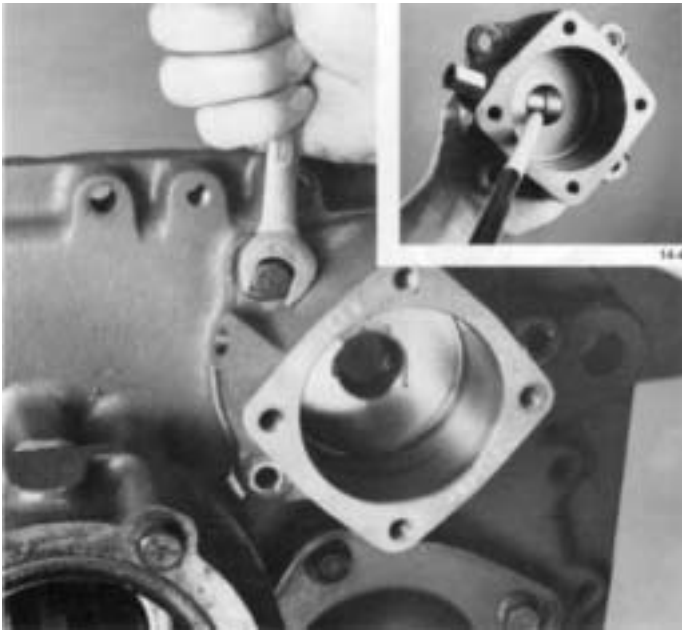

7. Turn out capscrews and remove range cylinder housing. If necessary, remove small O-ring from groove in housing bore (inset).

DISASSEMBLY-AUXILIARY SECTION

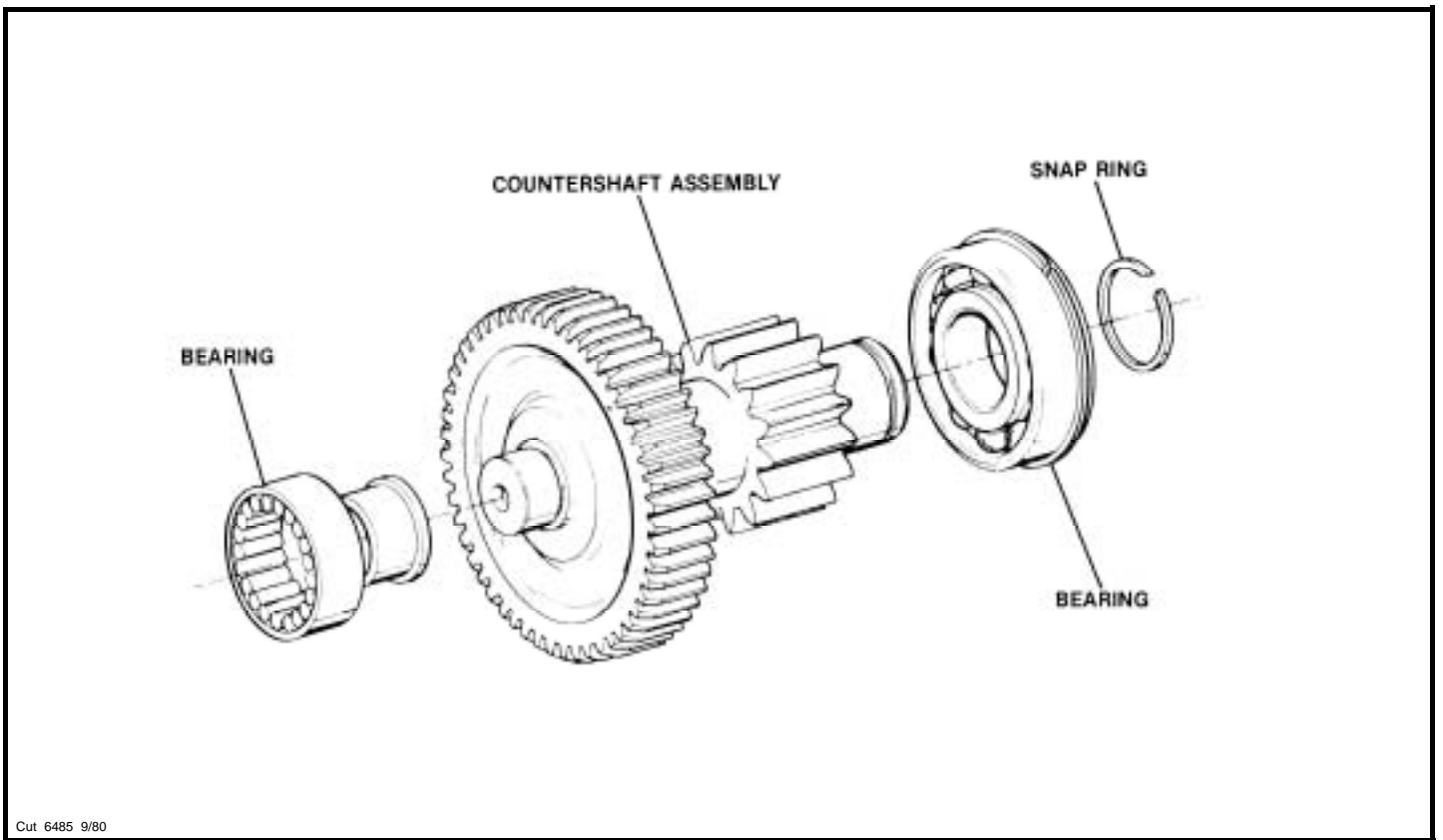

B. Removal of Auxiliary Countershaft Assemblies

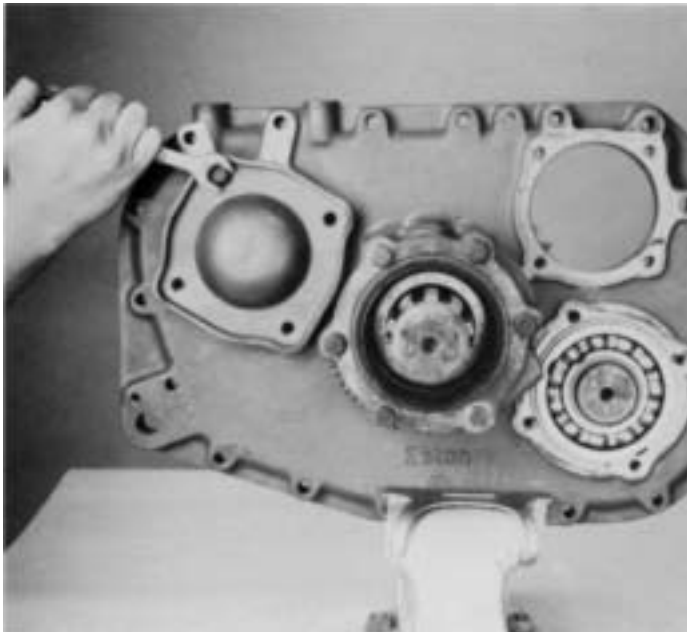

1. Turn out capscrews and remove both countershaft rear bearing covers and gaskets.

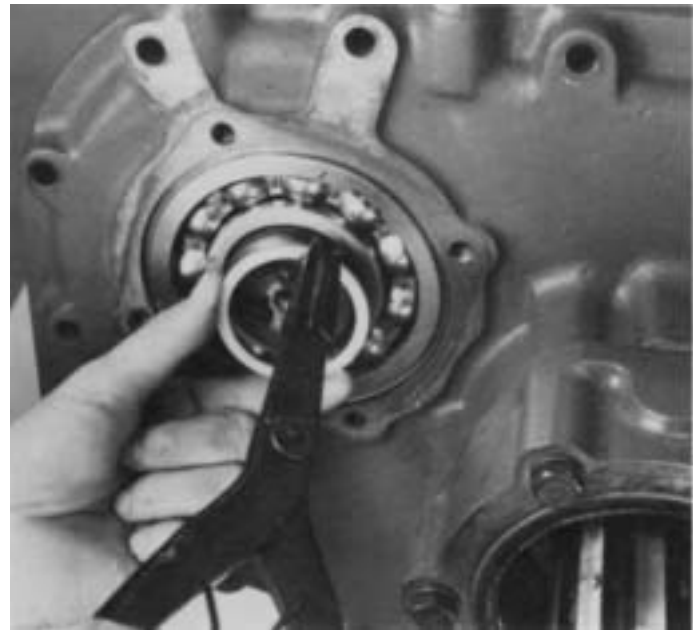

2. Remove snap ring from groove at rear of each countershaft.

DISASSEMBLY-AUXILIARY SECTION



3. Use a soft bar and maul to drive countershaft forward and from rear bearings.

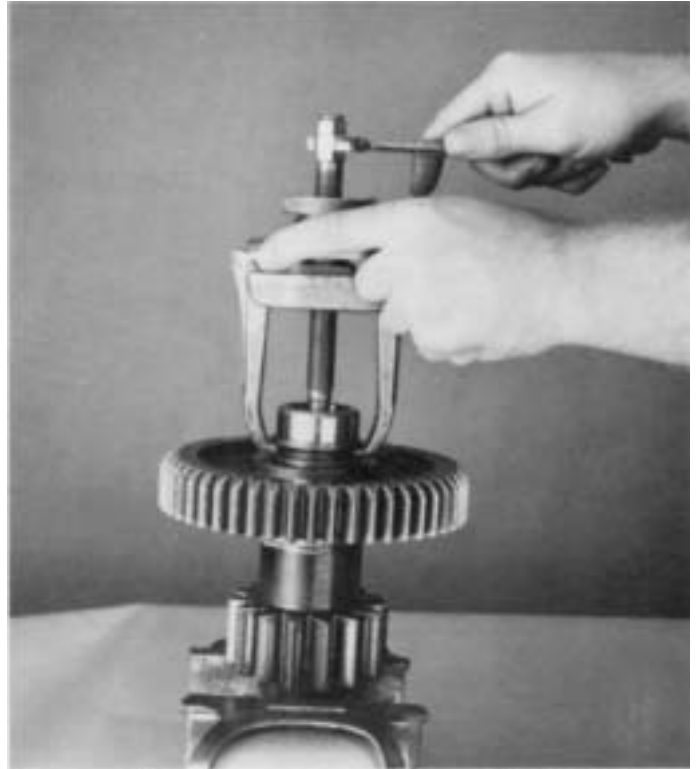

5. If necessary, secure assembly in a vise and remove bearing inner race from front of countershaft with jaw pullers.

NOTE: The vise used should be equipped with brass jaws or wood blocks to prevent damage to countershaft.



4. Remove bearings from bores in auxiliary plate by tapping lightly and evenly to rear with a soft bar.

DISASSEMBLY-AUXILIARY SECTION

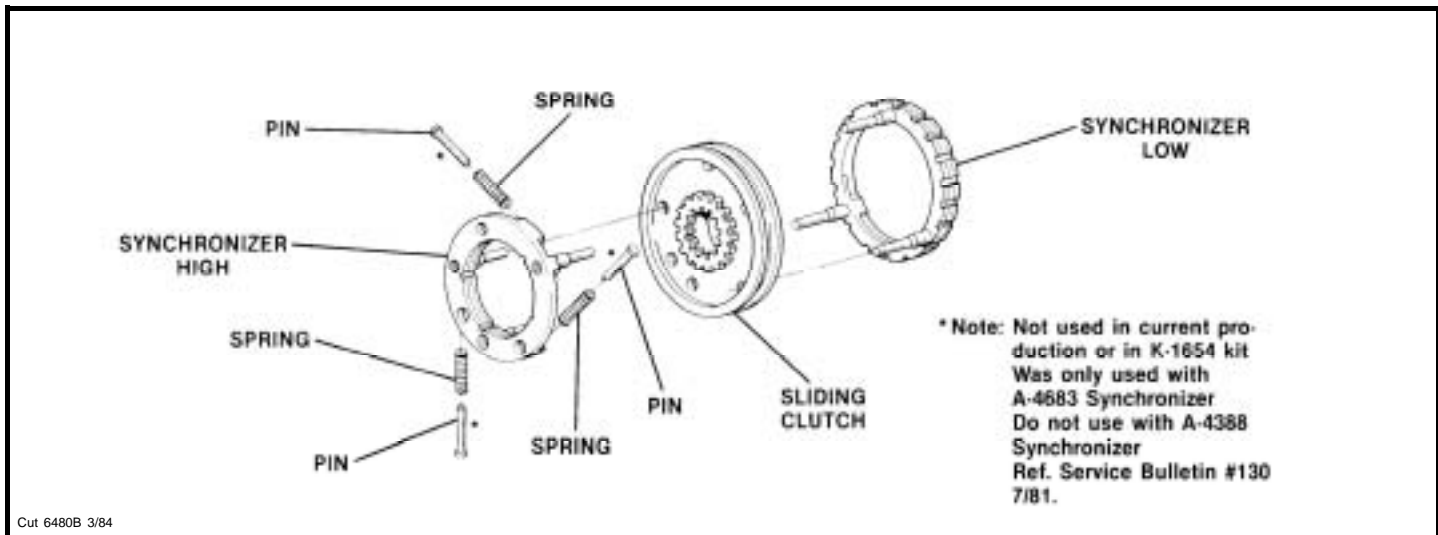

C. Removal and Disassembly of Synchronizer Assembly



1. Pull synchronizer assembly from splines of output shaft.



2. Place larger low range synchronizer ring on bench and pull high range synchronizer from blocker pins. However, before doing so, cover the assembly with a shop rag to prevent losing the three springs released from high range synchronizer at pin locations.



3. Remove sliding clutch from pins of low range synchronizer ring.

DISASSEMBLY—AUXILIARY SECTION

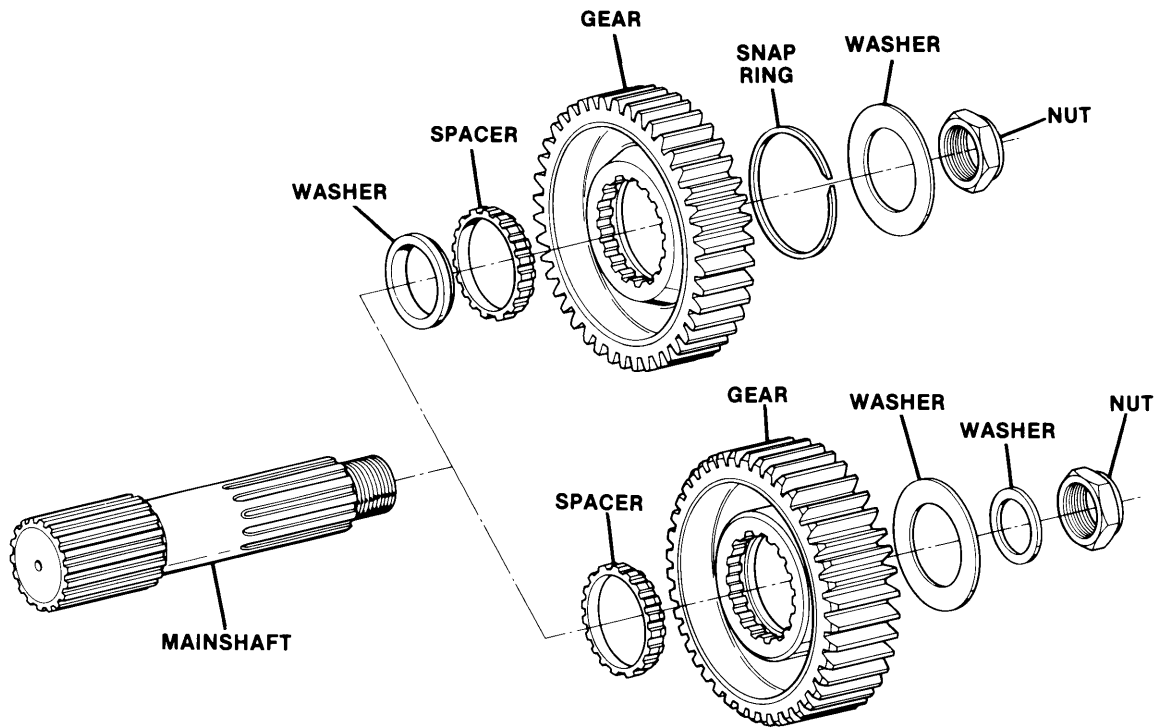

Cut 6551A 4/84

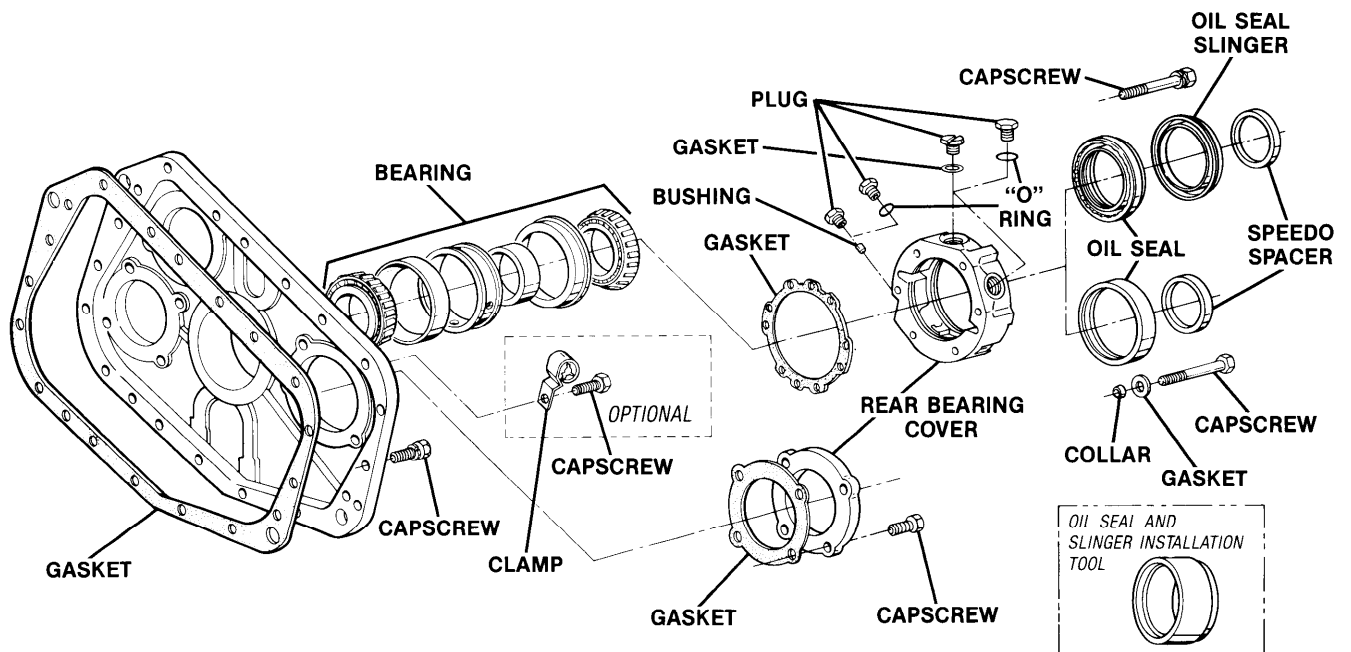

Cut 6544 11/84

DISASSEMBLY-AUXILIARY SECTION

D. Removal and Disassembly of Output Shaft and Rear Bearing Assemblies



1. Use a soft bar and maul to drive output shaft forward and through rear bearing assembly.

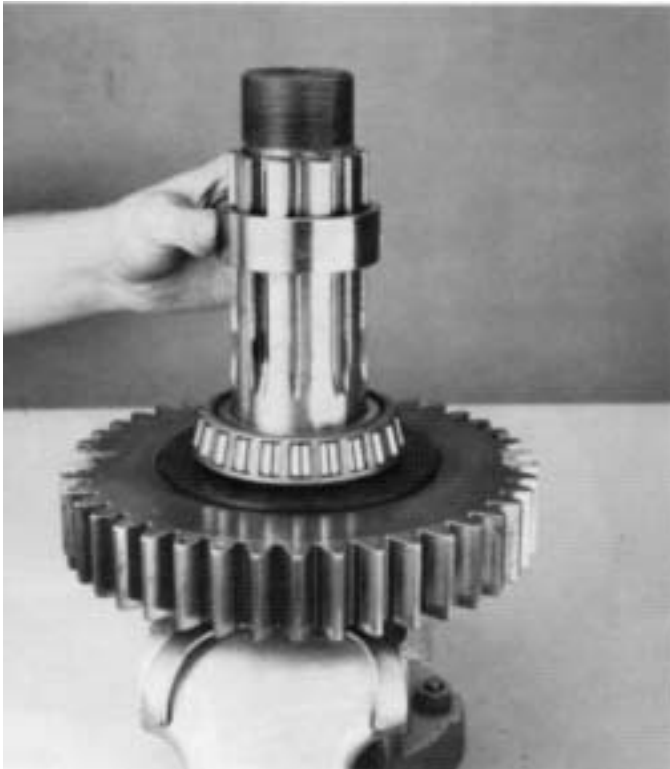

2. Remove bearing inner spacer from output shaft.



3. Using front face of low range gear as a base, press the output shaft through gear and bearing. Remove bearing and washer from hub of low range gear.

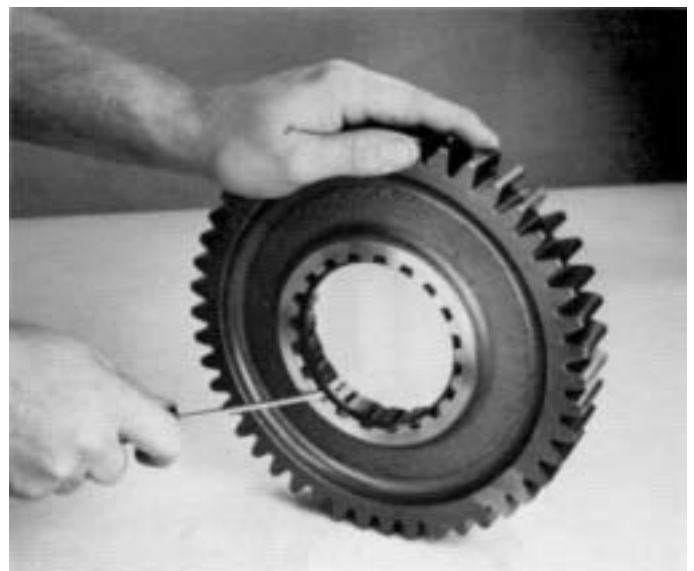

4. If necessary, remove snap ring from low range gear of models so equipped.

DISASSEMBLY-AUXILIARY SECTION



5. Remove splined spacer from output shaft.



7. Turn out capscrews and remove rear bearing cover. Rear bearing cone will drop from bore in auxiliary plate when cover is removed. If necessary, remove oil seal from cover (inset).

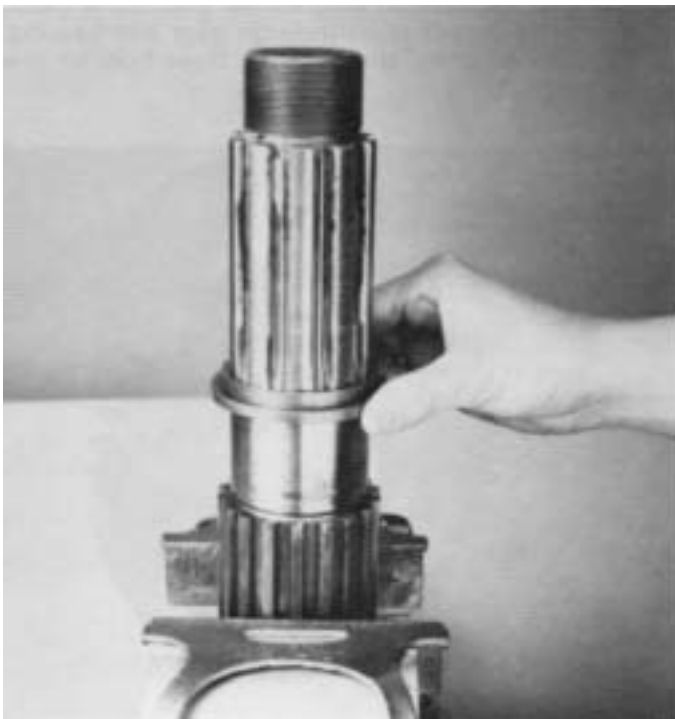

6. Remove stepped washer from shaft of models so equipped.



8. Remove two bearing cups and outer spacer from bore in auxiliary plate.

REASSEMBLY-AUXILIARY SECTION

AUXILIARY SECTION

A. Reassembly and Installation of Output Shaft and Rear Bearing Assemblies



1. Secure output shaft in a vise with threaded end up. For 11608 models, install stepped washer on shaft large diameter down (arrow), then install splined spacer.

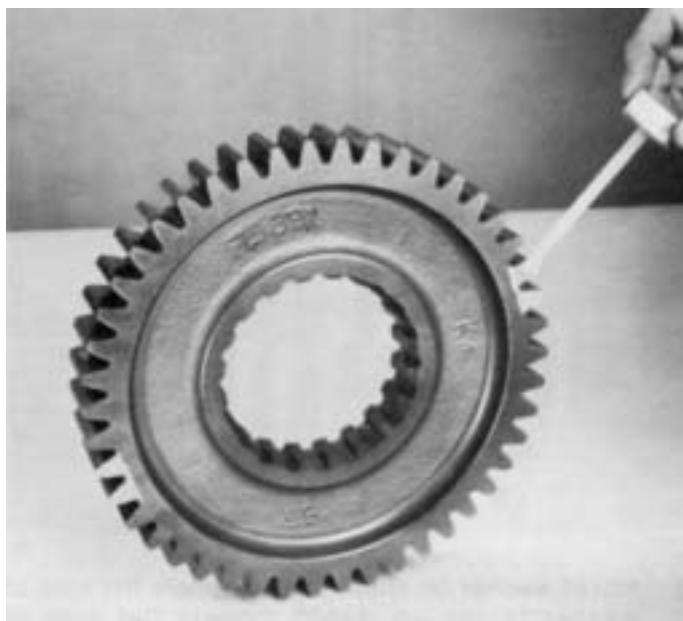

3. **IMPORTANT:** Mark any two adjacent teeth on low range gear and repeat procedure for two adjacent teeth directly opposite first set marked. A highly visible color-of toolmakers' dye is recommended.



2. For 14608 models, install spacer with large diameter splines down.



4. If previously removed, install snap ring in low range gear of models so equipped (inset). Install the gear on output shaft, clutching teeth down and engaged with splines of spacer.

REASSEMBLY-AUXILIARY SECTION

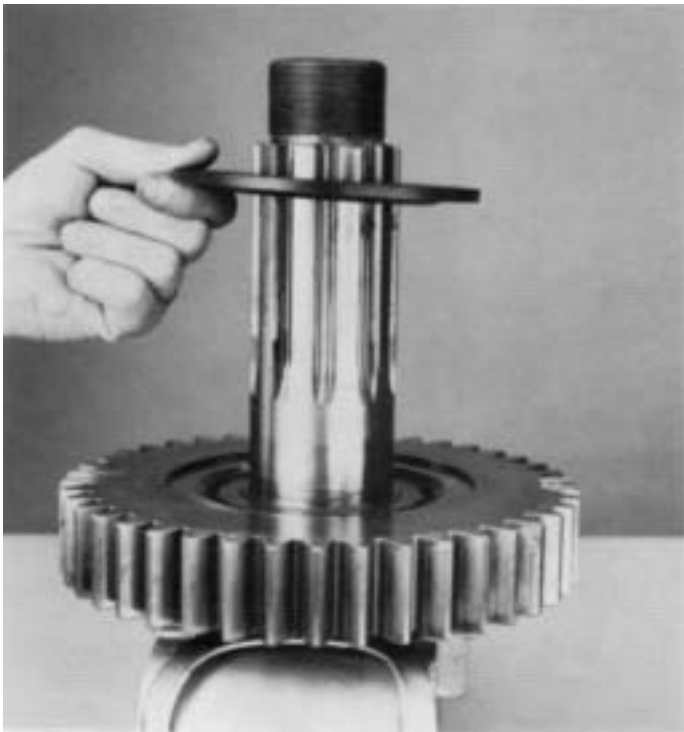

5. Install washer on shaft; 11608 models flat side of washer facing up, 14608 models flat side of washer facing down.

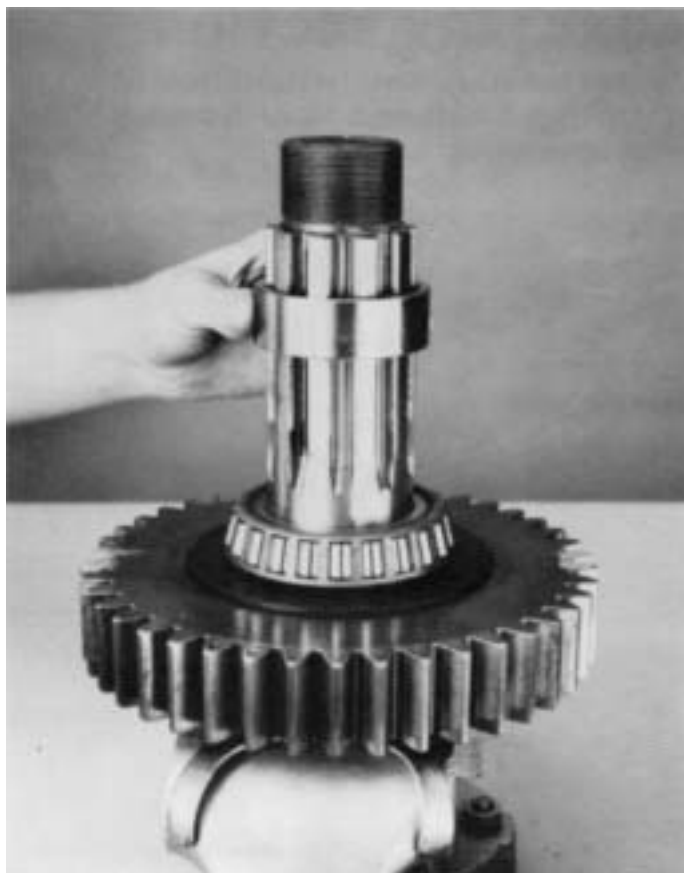

7. Install bearing inner spacer on output shaft.



6. Heat front bearing cone and install on shaft against washer, bearing taper up.
NOTE: DO NOT HEAT BEARING ABOVE 275°F (136°C). If possible, use heat lamps as source.



8. Install front bearing cup in bore of auxiliary plate, taper to the inside. Use a soft bar to start cup into bore.

REASSEMBLY-AUXILIARY SECTION



9. Place bearing outer spacer against cup and use a soft bar or flanged-end driver to move both parts evenly into bore.

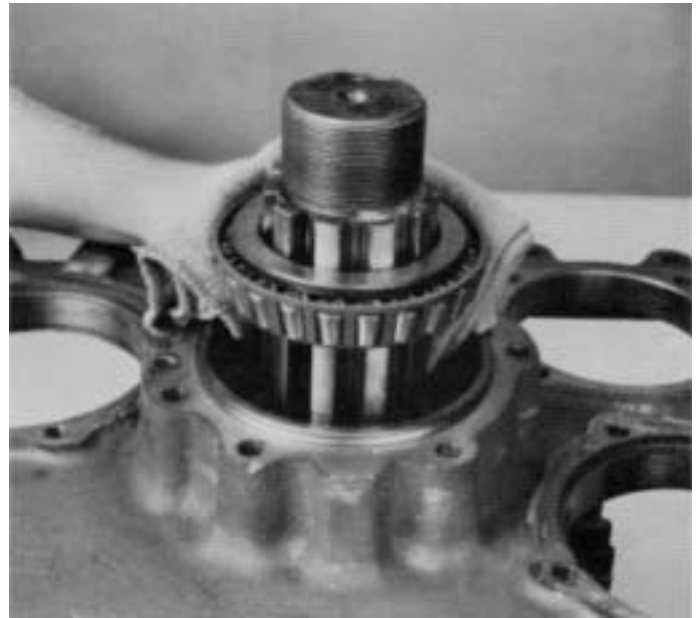

11. Install auxiliary plate over end of output shaft assembly. Heat rear bearing cone and install on shaft, taper down and inside bearing cup.

NOTE: DO NOT HEAT BEARING ABOVE 275°F (136°C).



10. Place rear bearing cup against spacer. Use a flanged-end driver to move all three parts evenly into bore until lip of rear bearing cup seats on auxiliary plate.

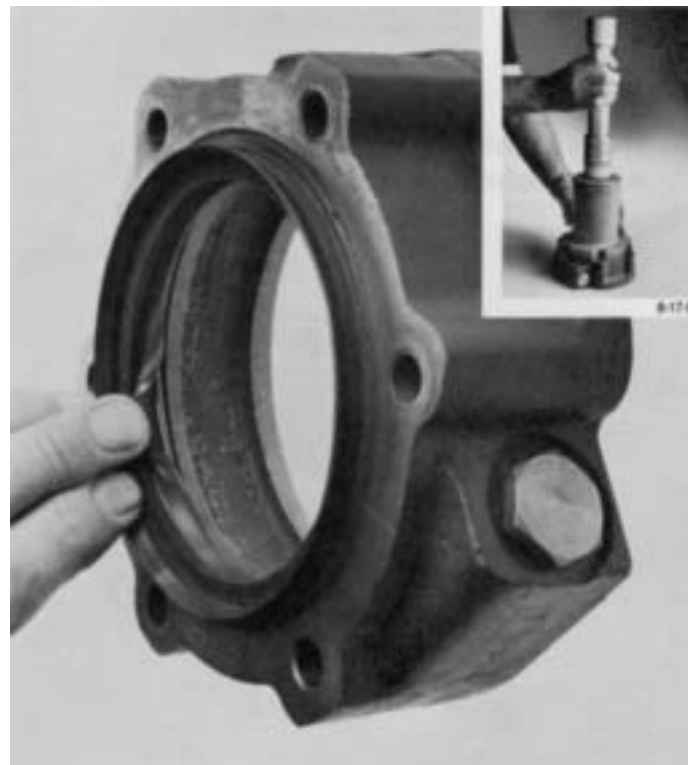

12. If previously removed, install oil seal in rear bearing cover with a flanged driver (inset). Seal should be installed so the spring is to front of transmission.

REASSEMBLY-AUXILIARY SECTION

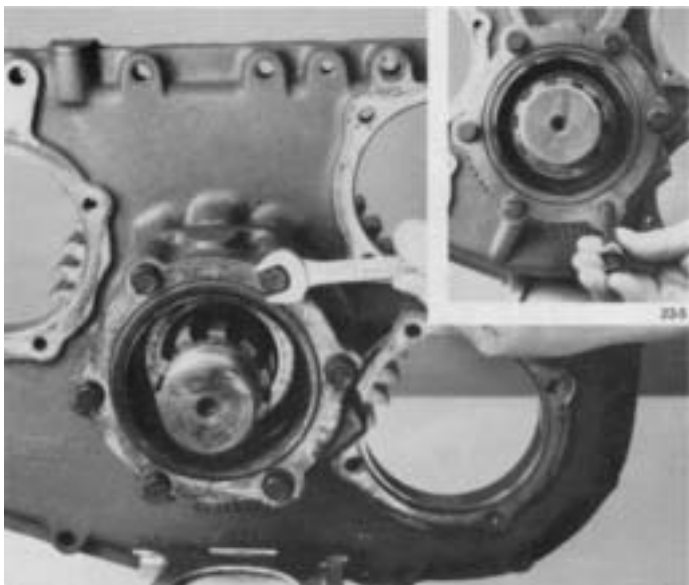

13. Remount the assembly upright in vise and secure on flange of auxiliary plate. Position corresponding new gasket on cover mounting surface and install the rear bearing cover. Use the nylon collar and brass washer with capscrew at the chamfered hole which intersects speedometer bore (inset). Secure cover to auxiliary plate.

NOTE: Because collar becomes distorted when compressed, DO NOT RE-USE OLD NYLON COLLAR.



2. Install three springs in bores of high range synchronizer ring.

B. Reassembly and Installation of Synchronizer Assembly



1. Place larger low range synchronizer ring on bench and install sliding clutch on blocker pins, recessed side up.



3. Place high range synchronizer ring over blocker pins of low range synchronizer, seating springs against pins.

REASSEMBLY-AUXILIARY SECTION



4. Apply downward pressure to high range synchronizer ring WHILE TWISTING COUNTER-CLOCKWISE to compress springs and fully seat ring on blocker pins of low range synchronizer.



5. Install synchronizer assembly on splines of output shaft, low range ring in recess of low range gear.

C. Timing and Installation of Auxiliary Countershaft Assemblies



1. If previously removed, install bearing inner race on front of each countershaft.

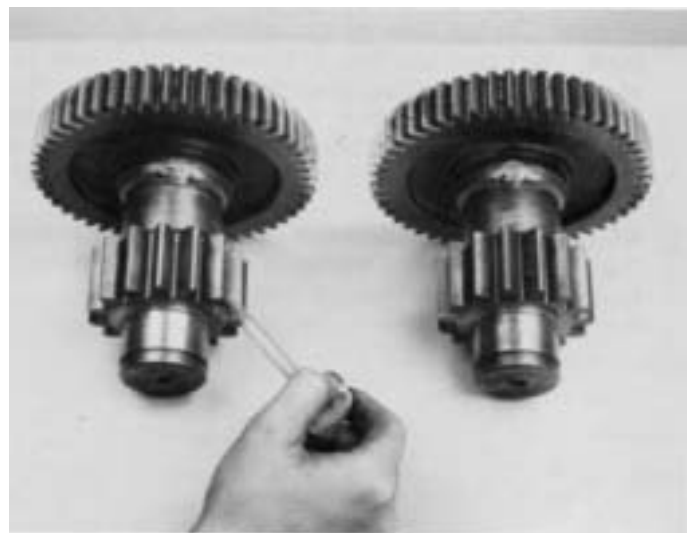

2. **IMPORTANT:** On low range gear of each auxiliary countershaft assembly, use a highly visible color of toolmaker's dye to mark the tooth stamped with an "O" for timing purposes.

REASSEMBLY-AUXILIARY SECTION (10-SPEED MODELS)

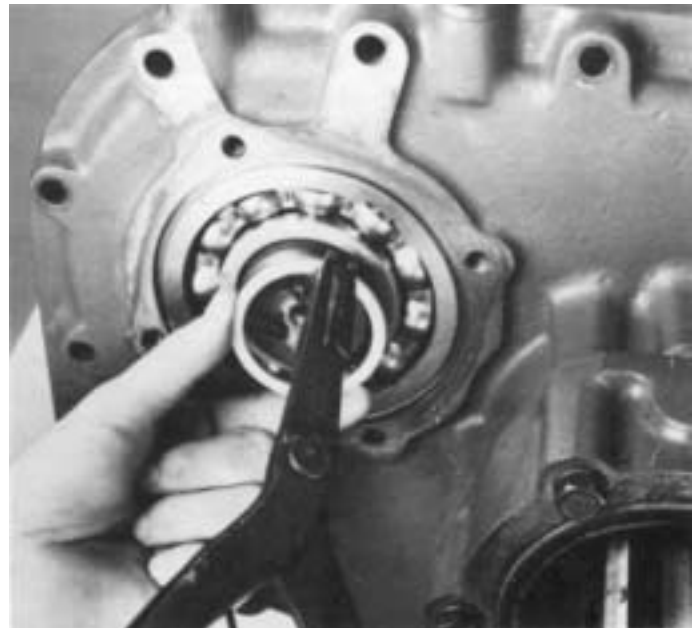
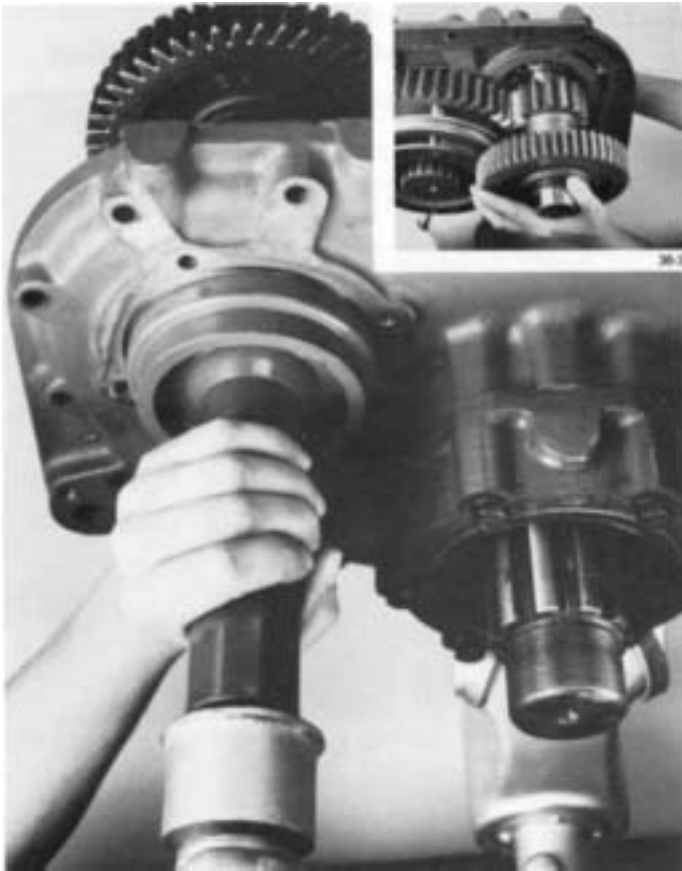

4. Install snap ring in groove at rear of each countershaft.

3. Place one countershaft assembly into position in rear plate, meshing the marked tooth of countershaft low range gear with either set of two marked teeth of low range gear on output shaft (inset). Center rear of countershaft in bearing bore, start rear bearing in bore and complete installation with a flanged-end driver and maul. Repeat the procedure with other auxiliary countershaft assembly, making sure the low range gear set remains in time during bearing installation.

NOTE: Check synchronizer assembly for springs that may have been released from bores in high range ring during bearing installation.

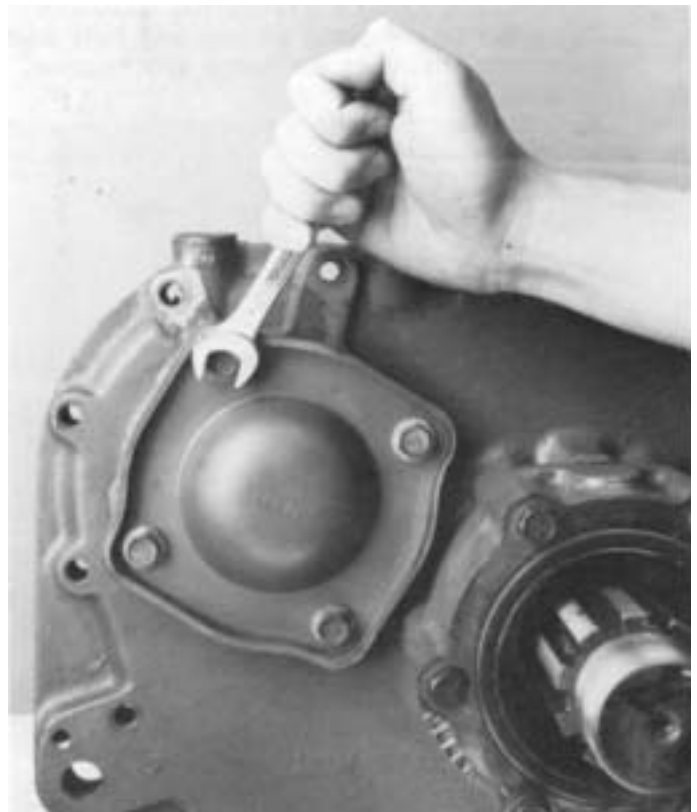

5. Position corresponding new gasket on cover mounting surface and install both rear bearing covers.

REASSEMBLY-AUXILIARY SECTION

D. Reassembly and Installation of Range Cylinder Assembly

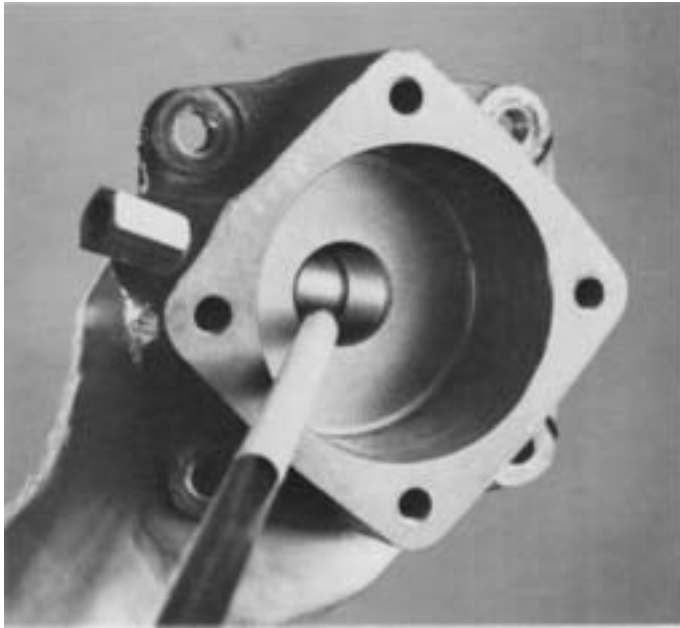

1. If previously removed, install O-ring in bore of range cylinder housing.

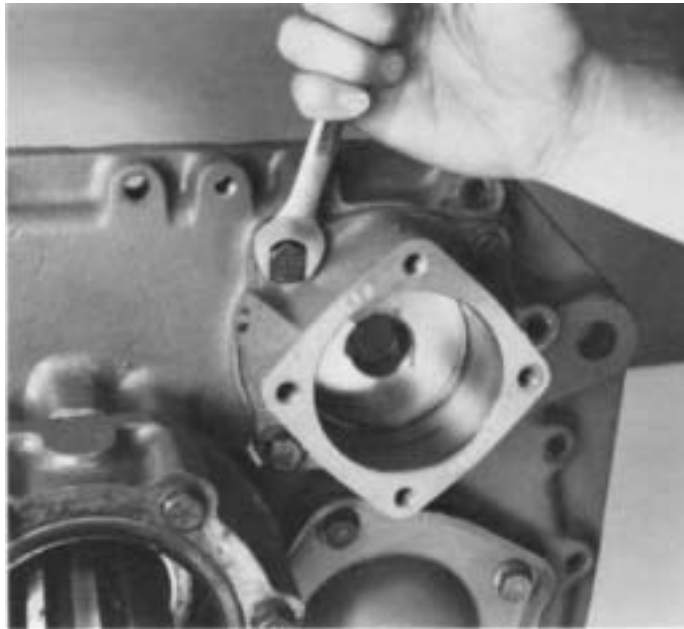

2. Position corresponding new gasket on housing mounting surface and install cylinder housing in rear bore of auxiliary plate, air fitting to the upper left. Secure housing to plate.

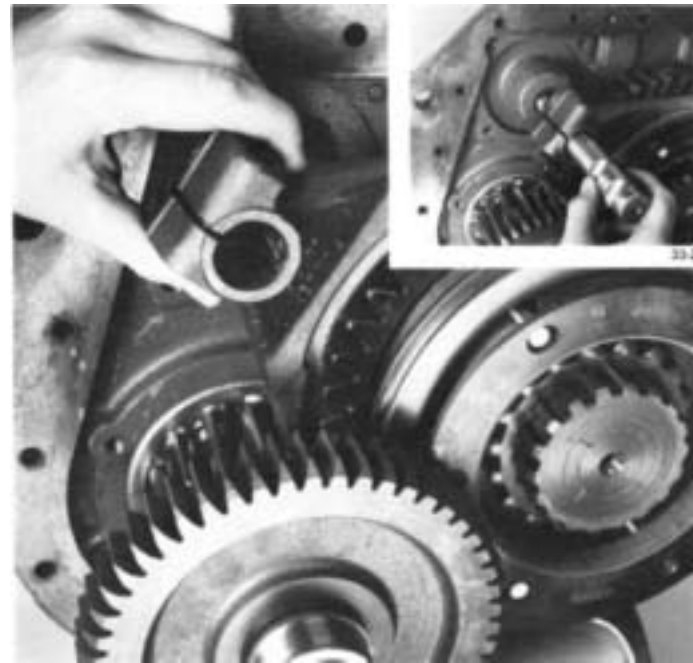

3. Place range yoke into position with sliding clutch of synchronizer assembly, long hub of yoke to the front (RT-11608 Series); long hub of yoke to the rear (RT-14608 Series). Insert threaded-end of yoke bar through yoke and into bore of range cylinder housing, aligning notches in bar with yoke lockscrew holes (inset).

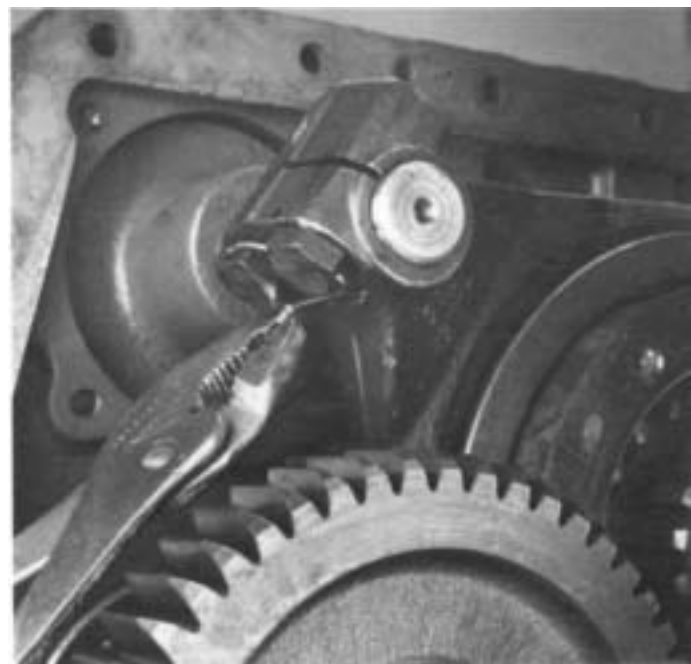

4. Install two yoke lock screws, tighten and wire securely.

REASSEMBLY-AUXILIARY SECTION



5. If previously removed, install O-rings in I.D. and O.O. of range piston.

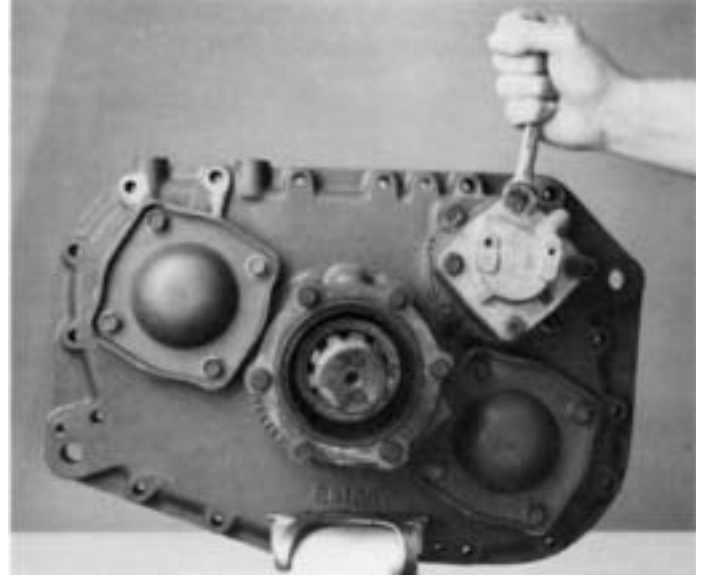

7. Position corresponding new gasket on cover mounting surface and install range cylinder cover on housing, open port to the upper left. Tighten capscrews to secure cover to housing.

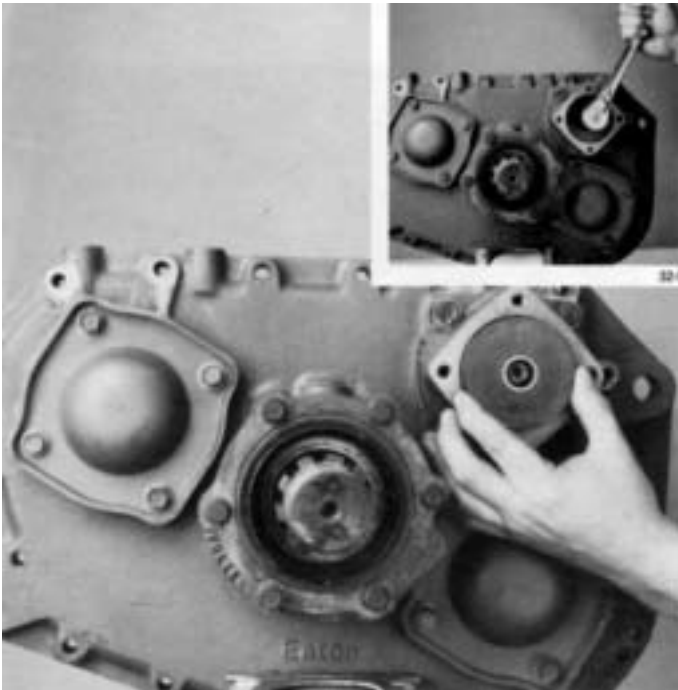

6. In cylinder housing bore, install range piston on yoke bar, flat side to the rear. Secure with nut tightened to recommended torque ratings (Inset).

DISASSEMBLY,, FRONT SECTION

A. Removal of Front Bearing Cover and Input Shaft Nut



1. Turn out retaining capscrews and remove drive gear bearing cover and gasket.

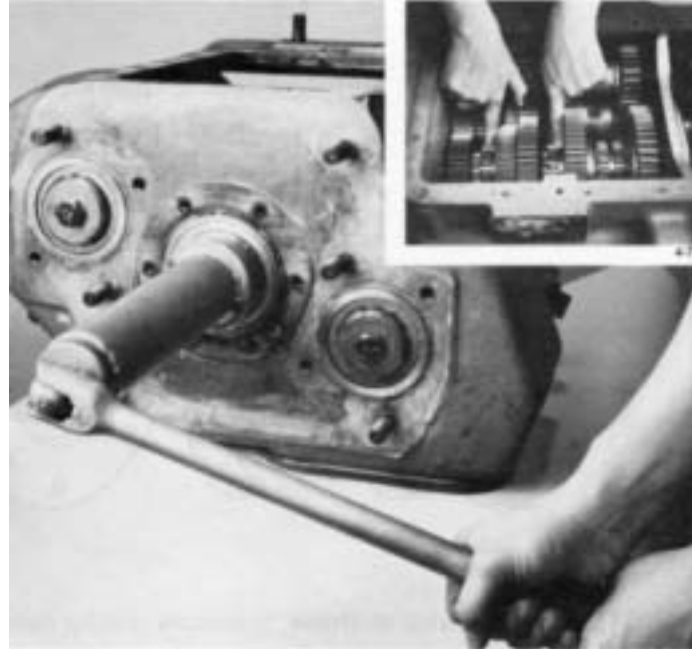

3. Engage two mainshaft sliding clutches into gear (inset), this prevents transmission from rotating. Remove nut (left hand thread) with drive gear nut removing tool.

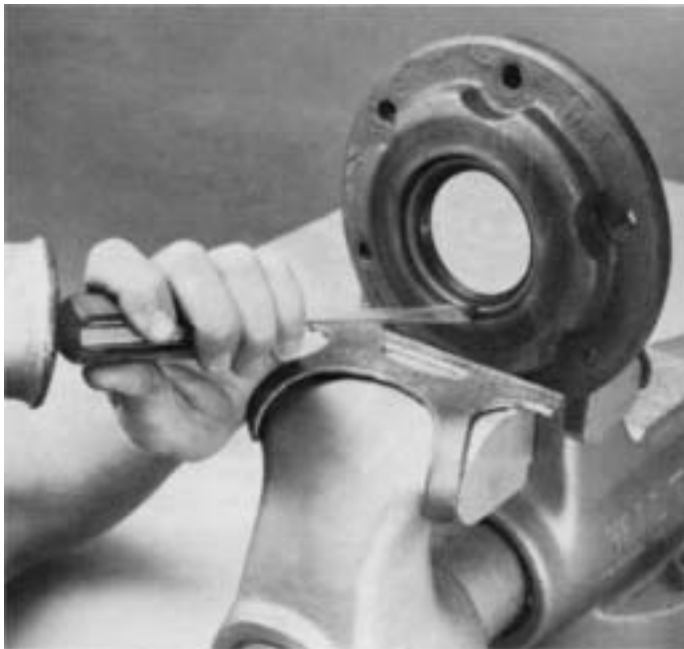

2. If necessary remove oil seal from cover of models so equipped.

DISASSEMBLY - FRONT SECTION

CASE ASSEMBLIES

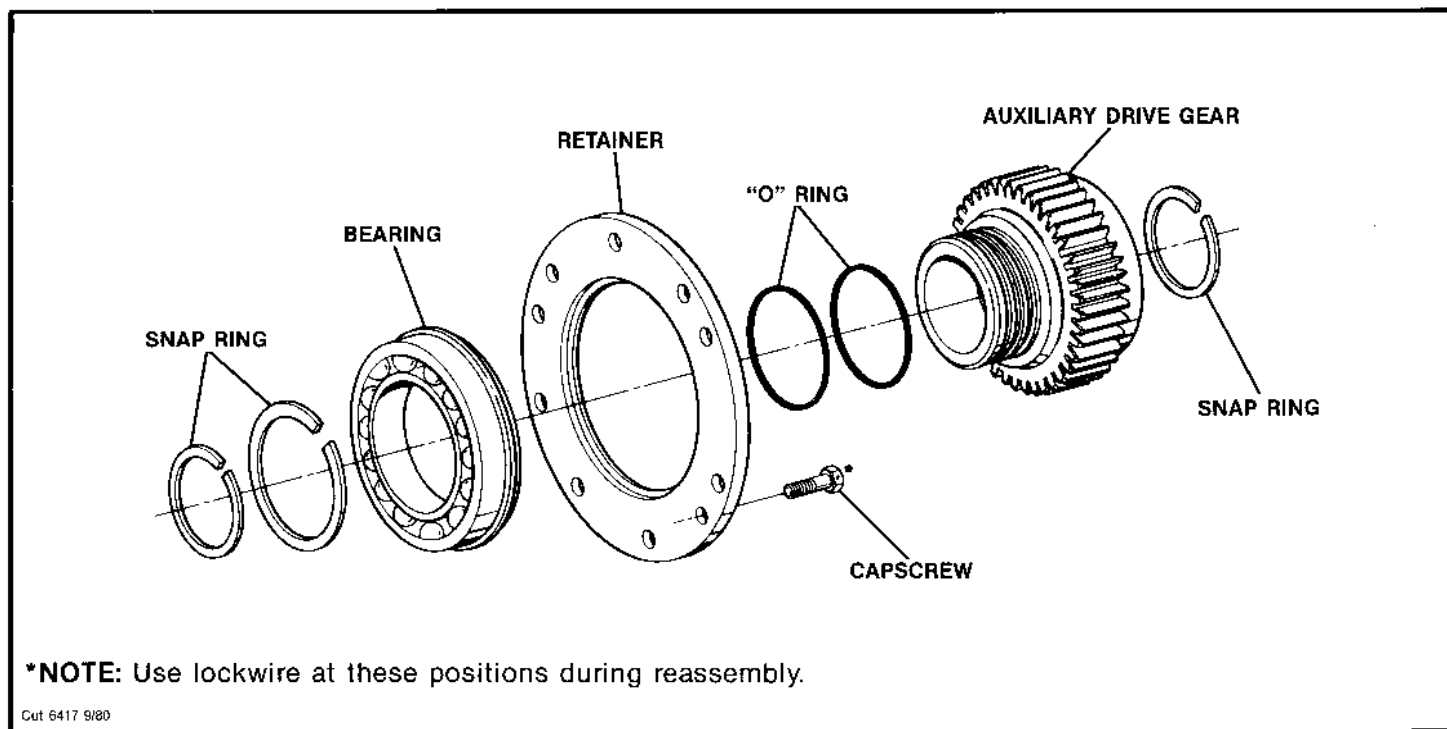

B. Removal and Disassembly of Auxiliary Drive Gear Assembly

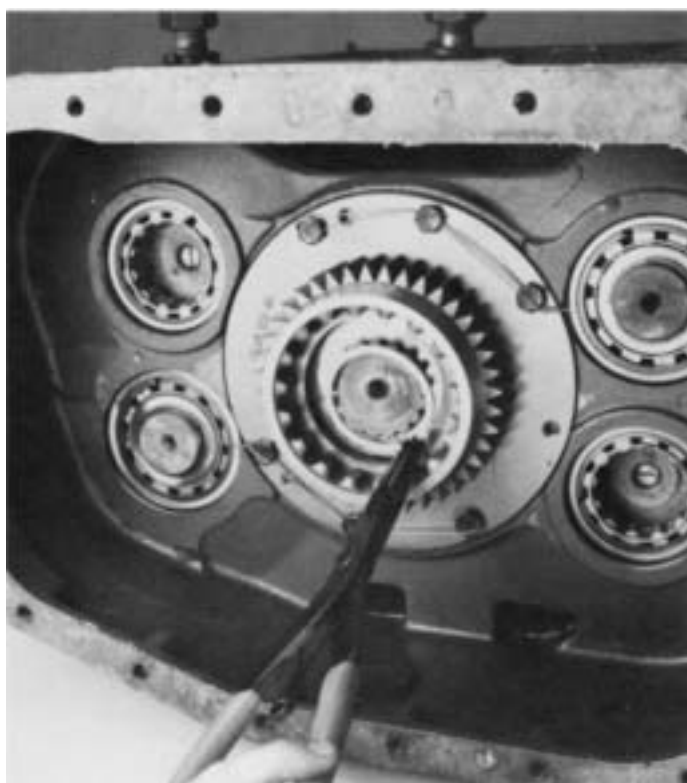

1. Remove snap ring from groove at rear of main shaft.

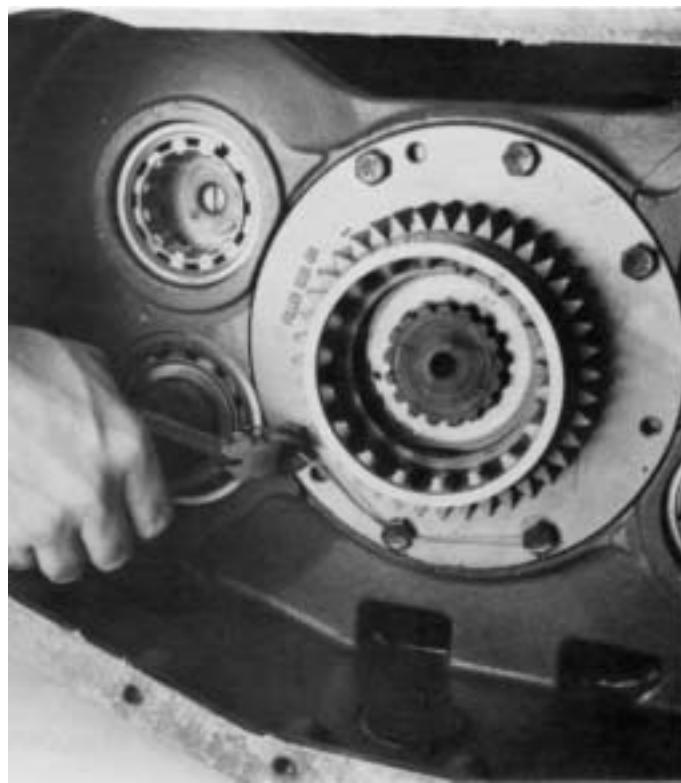

2. Cut lockwire and remove cap screws from bearing retainer ring.

DISASSEMBLYÑFRONT SECTION

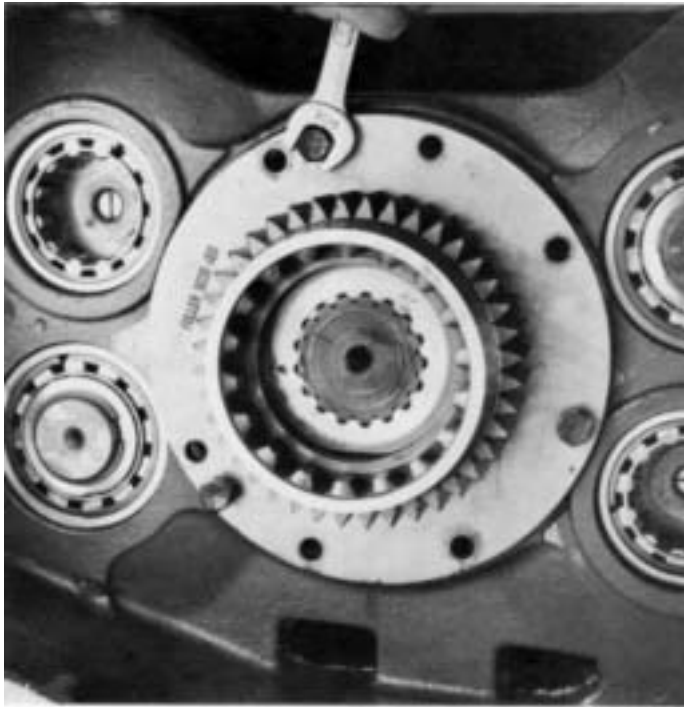

3. Insert three puller screws in the specially tapped holes of retainer ring. Tighten screws evenly to pull auxiliary drive gear assembly from case bore.



5. Using rear face of retainer ring as a base, press drive gear through bearing.



4. Remove snap ring from hub of auxiliary drive gear.



6. If necessary, remove O-rings from hub O.D. of auxiliary drive gear.

DISASSEMBLY-FRONT SECTION

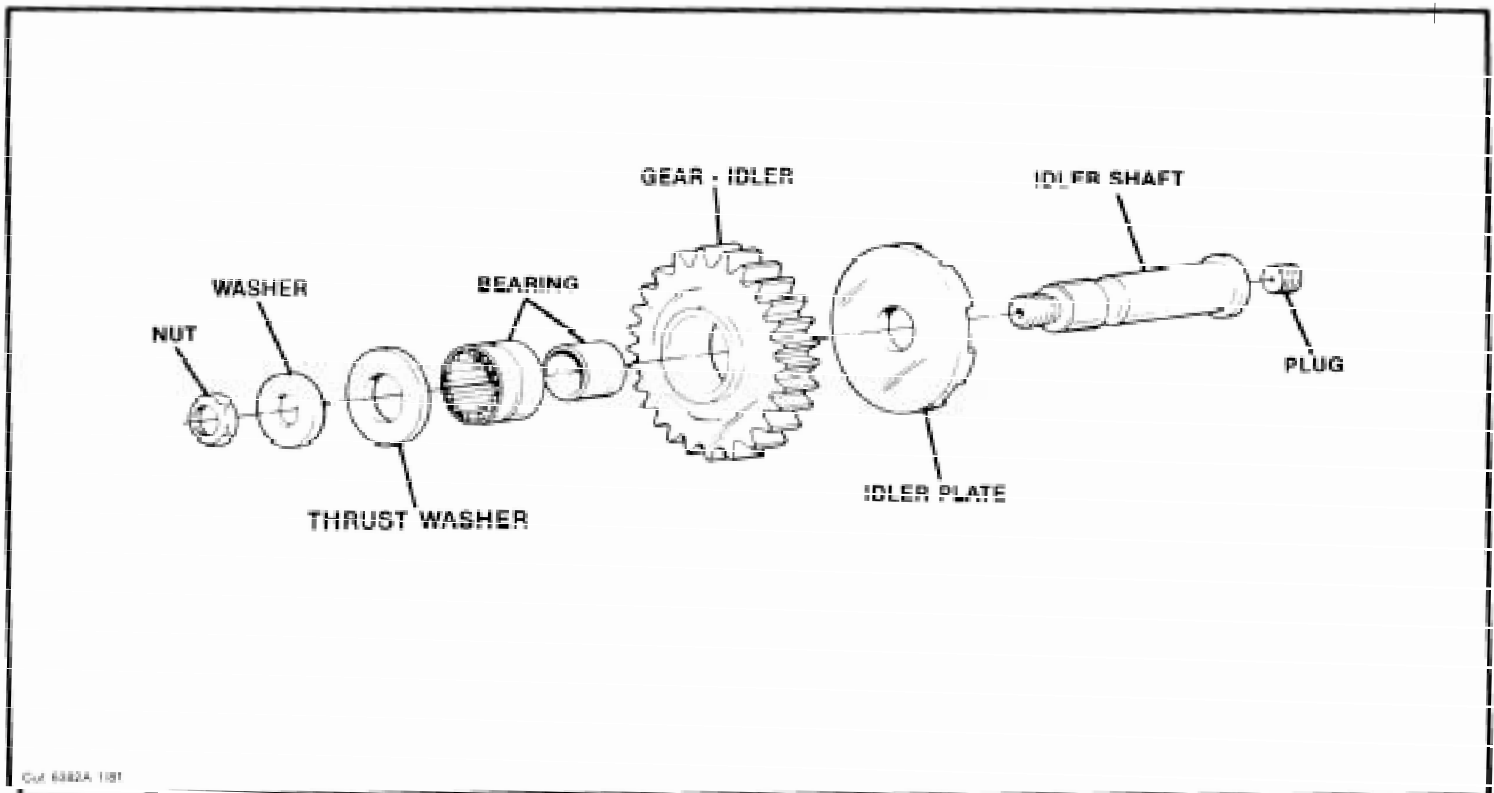

C. Removal and Disassembly of Left Reverse Idler Gear Assembly

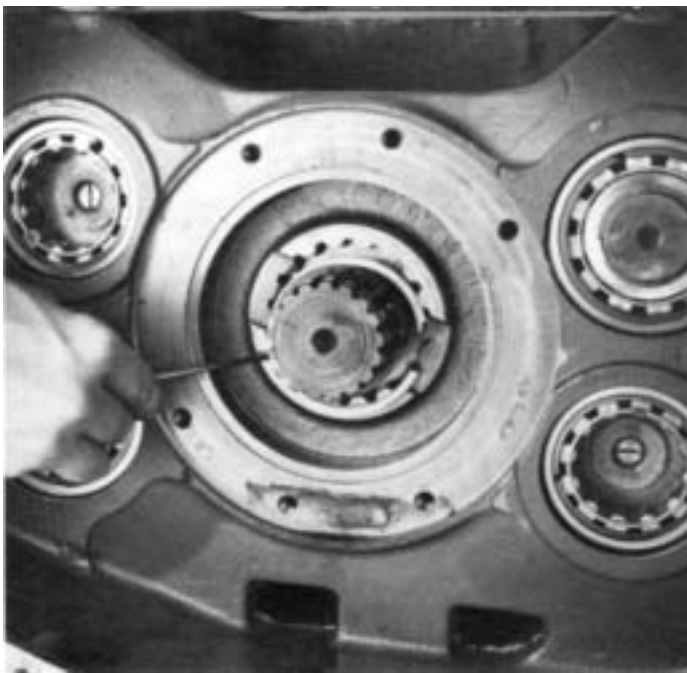

1. Move mainshaft reverse gear as far to rear as possible and remove snap ring from I.D. of gear.

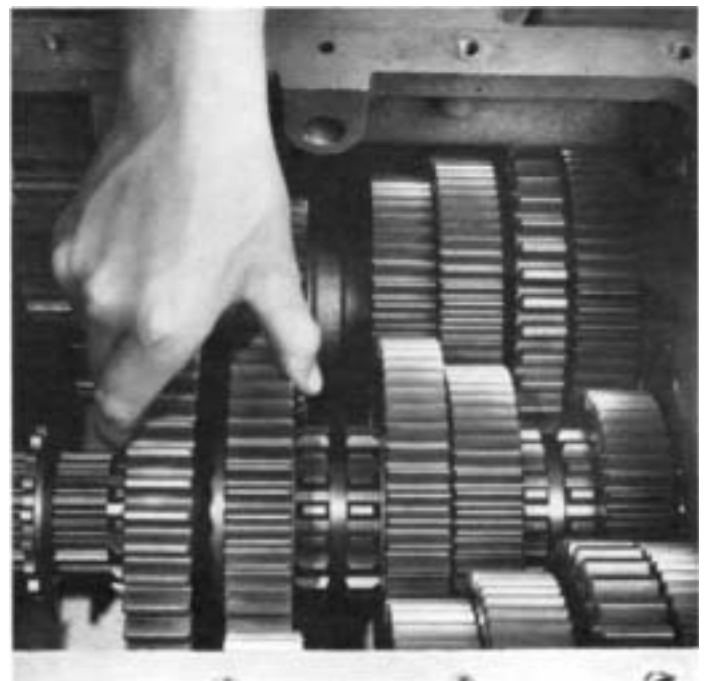

2. Move reverse gear forward and against spacer, engaging splines of mainshaft sliding clutch.

DISASSEMBLY-FRONT SECTION

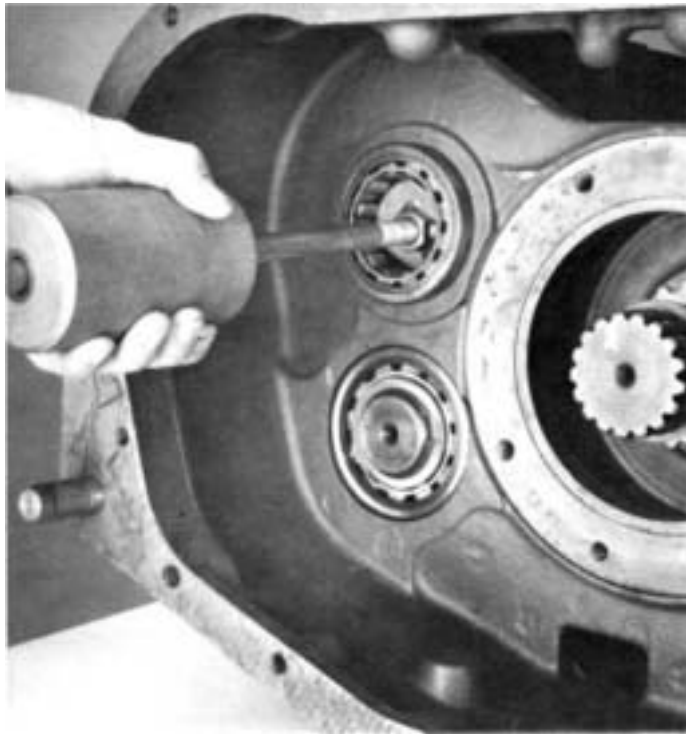

3. Using impact puller, remove auxiliary countershaft front bearing from left reverse idler gear bore. If necessary, repeat procedure for removing auxiliary countershaft front bearing from right reverse idler gear bore.

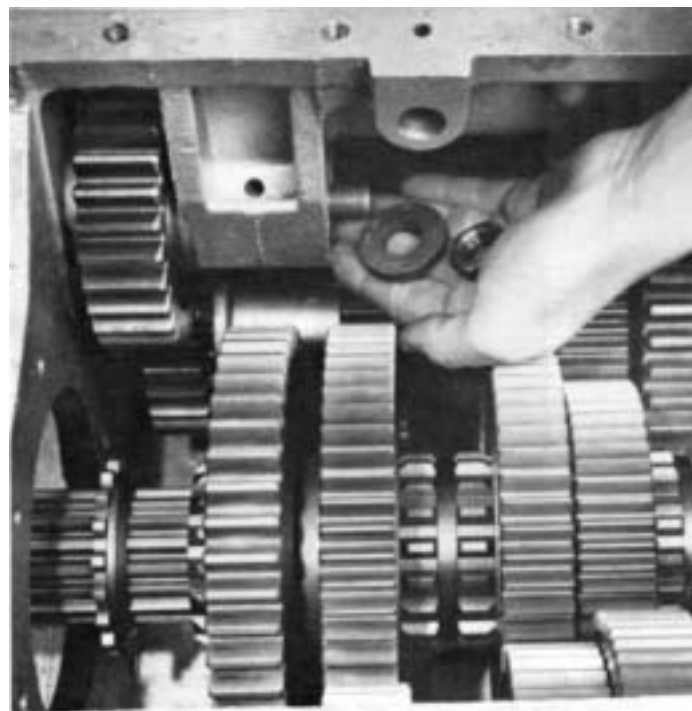

4. Turn out stop nut from front of idler shaft and remove washer.



5. Remove plug from rear of idler shaft and use an impact puller, 1/2-13 threaded end, to remove shaft from case bore (inset).

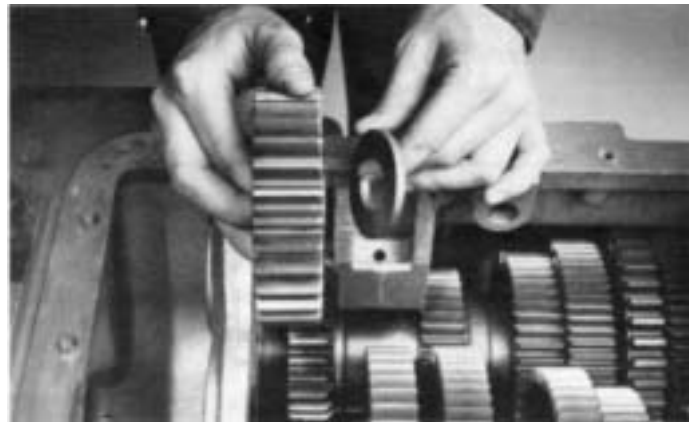

6. As idler shaft and idler plate is moved to the rear, remove the thrust washer, and gear from case.



7. If necessary, remove inner race from bearing and press needle bearing from idler gear.

DISASSEMBLY- FRONT SECTION

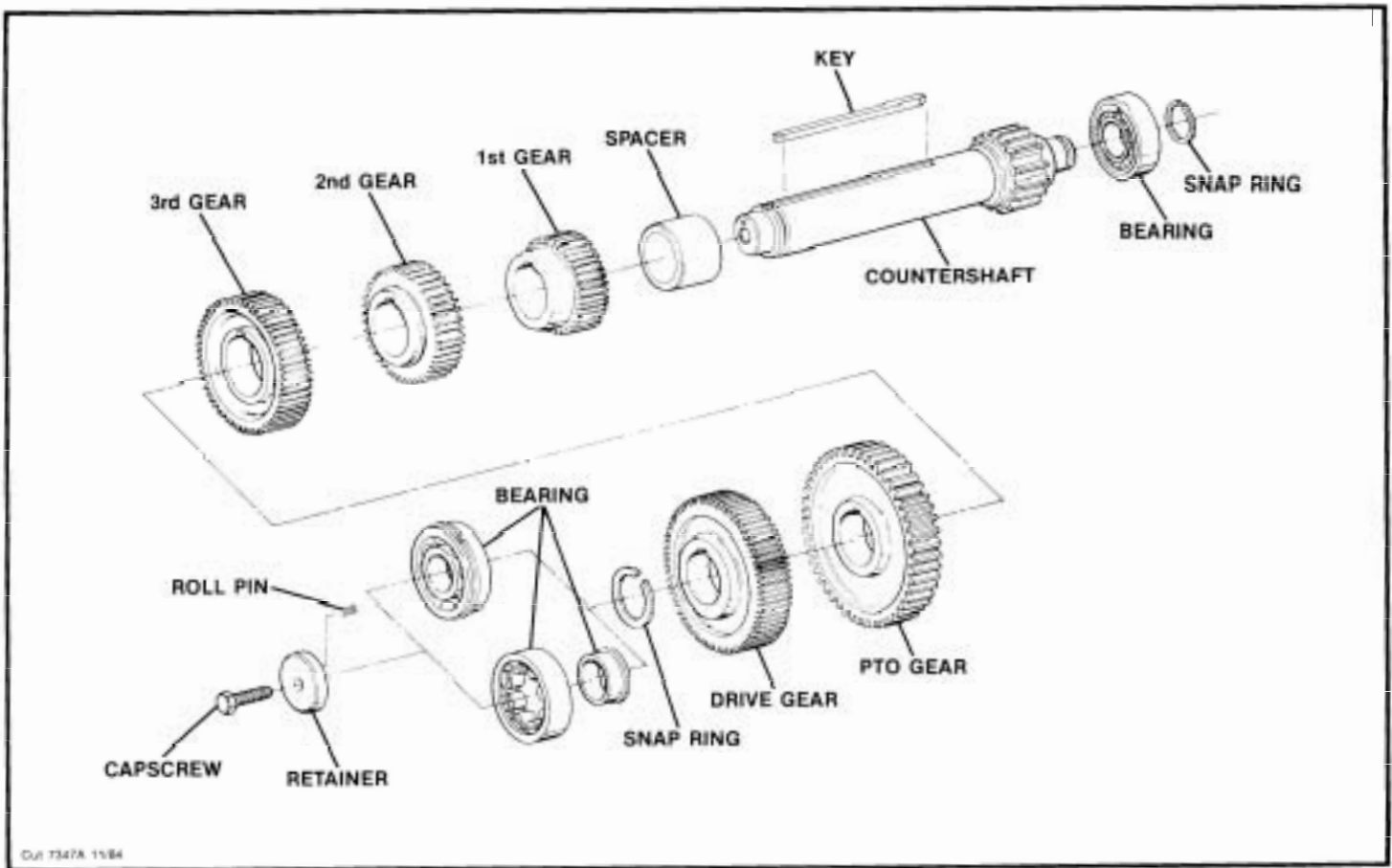

D. Removal of Countershaft Bearings

NOTE: In the following instructions, the front and rear bearings from BOTH countershaft are removed. For removal of the mainshaft assembly from case, it is necessary to remove the bearings from right countershaft ONLY.

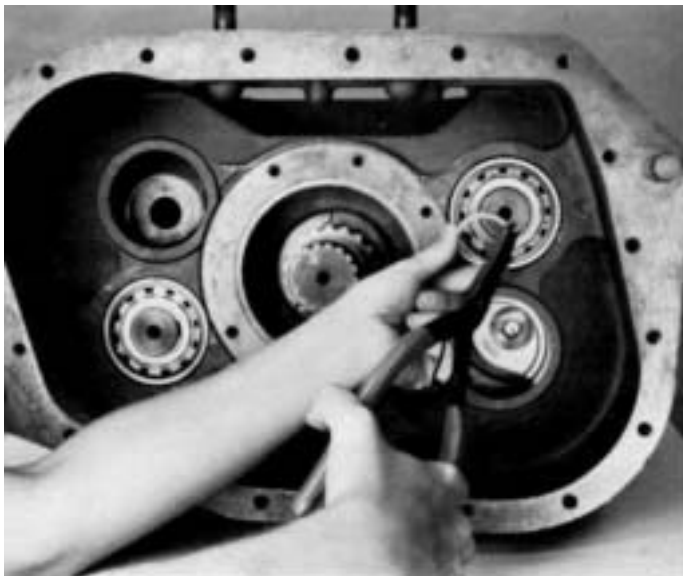

1. Remove snap ring from groove at rear of each countershaft.

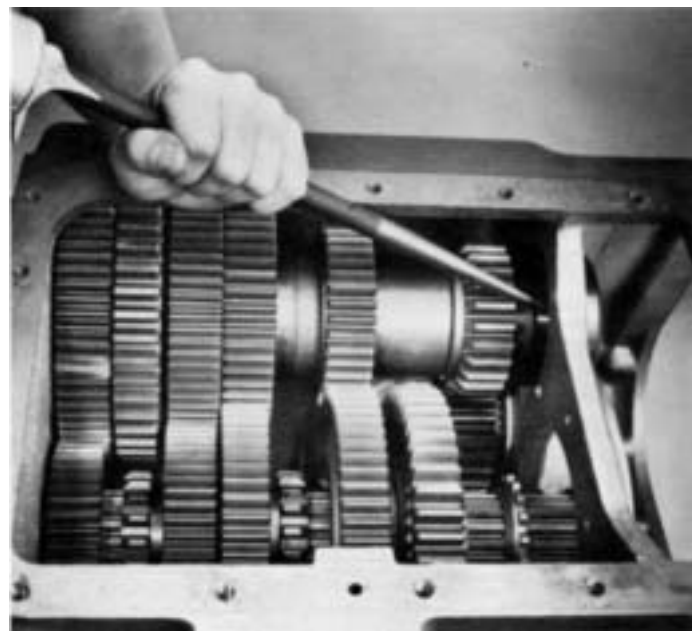

2. From inside case, use a soft punch and maul to drive the countershaft rear bearings to the rear and from case bores.

NOTE: This procedure will damage bearings and should not be attempted unless replacement of bearings is planned.

DISASSEMBLY-FRONT SECTION

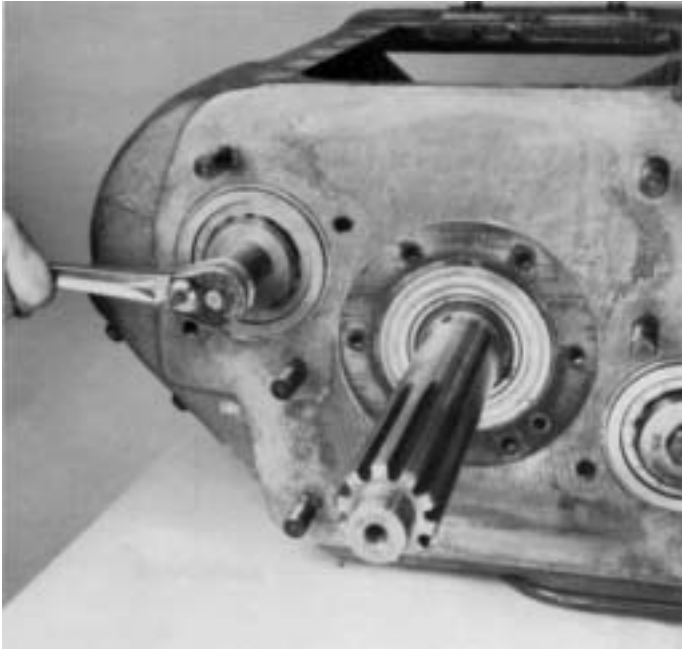

3. Turn out capscrew and remove front bearing retainer plate from right countershaft.

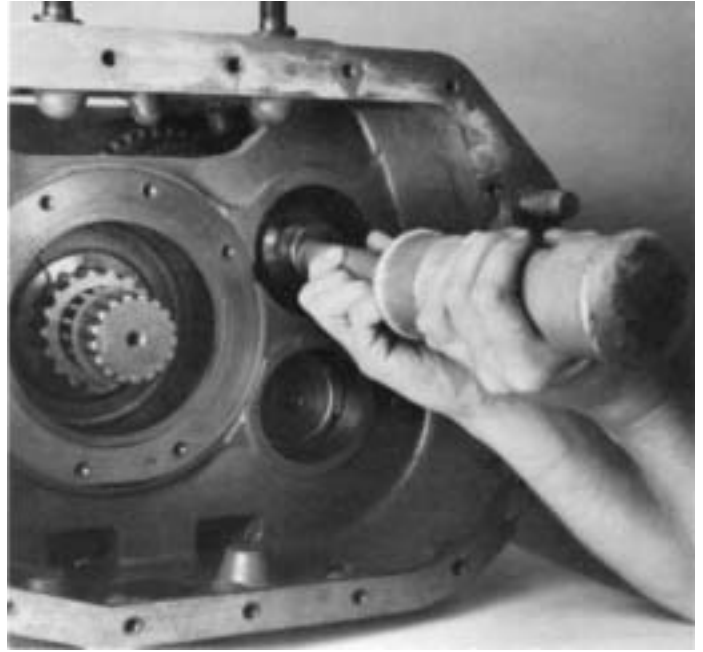

5. From the rear of case, use a soft bar and maul to drive right countershaft forward to unseat front bearing from case bore and expose the bearing snap ring.



4. Use a soft bar and maul to drive countershaft to the rear as far as possible. This will partially unseat the front bearing.
NOTE: The soft bar used should have a flattened end that is large enough so as not to damage holes for roll pin and capscrew.



6. Use a bearing puller to remove the countershaft front bearing.
NOTE: The bearing inner race of models equipped with roller-type front bearings will remain pressed on countershaft.

DISASSEMBLY—FRONT SECTION

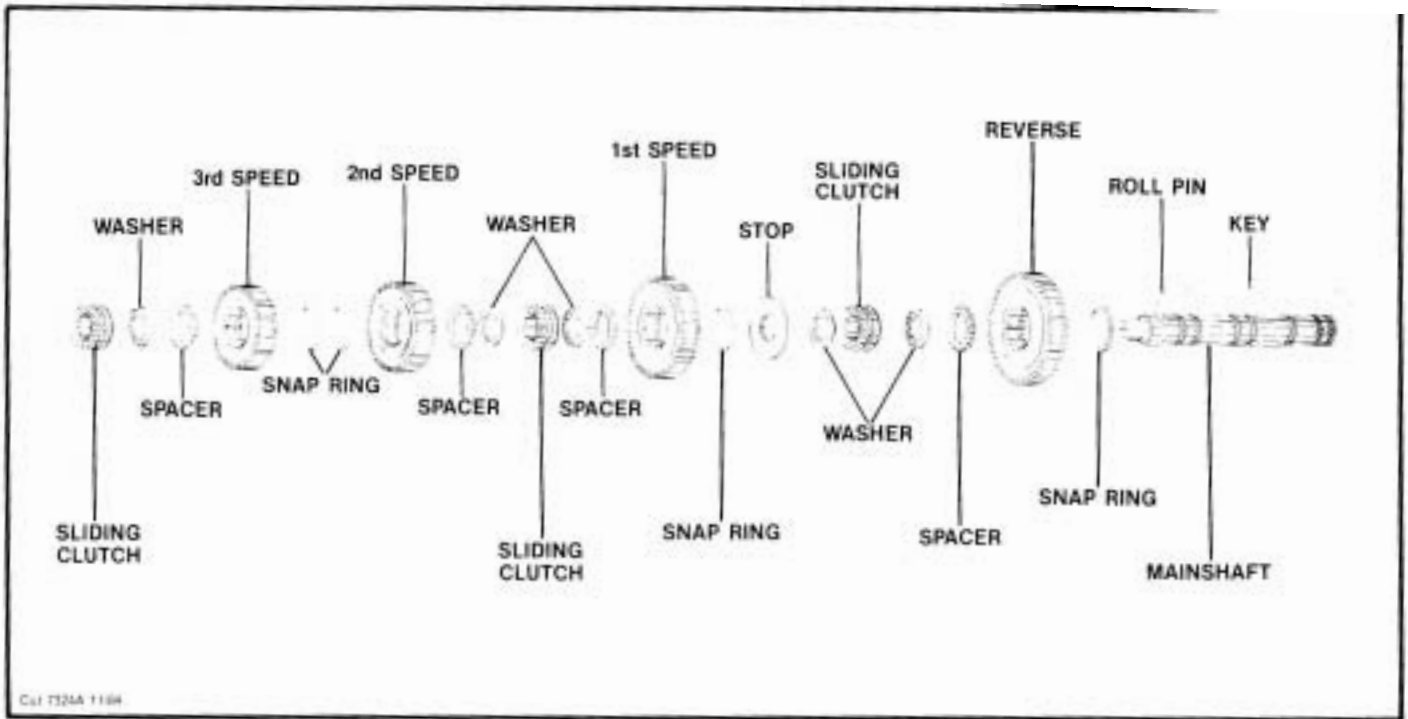

E. Removal and Disassembly of Mainshaft Assembly

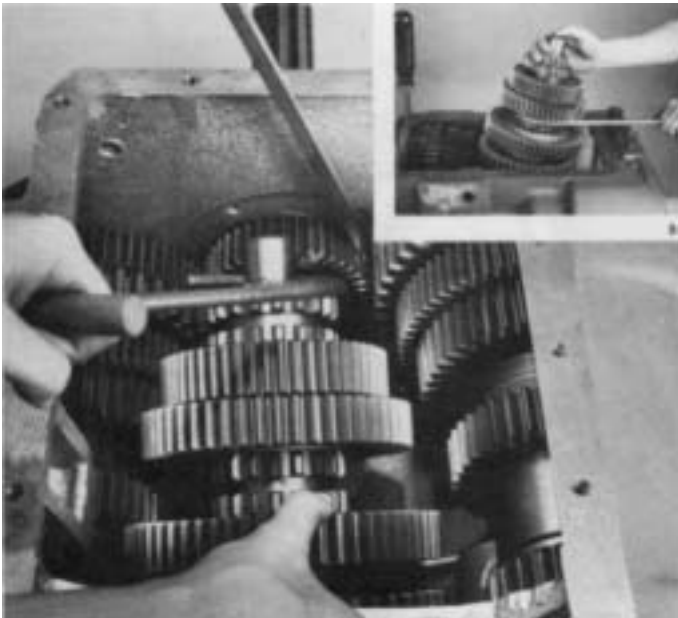

1. Block right countershaft assembly against case wall and pull mainshaft assembly to the rear to free pilot from pocket of input shaft. Tilt front of mainshaft up and lift assembly from case (inset). Use caution. Reverse gear is free and can fall from shaft.

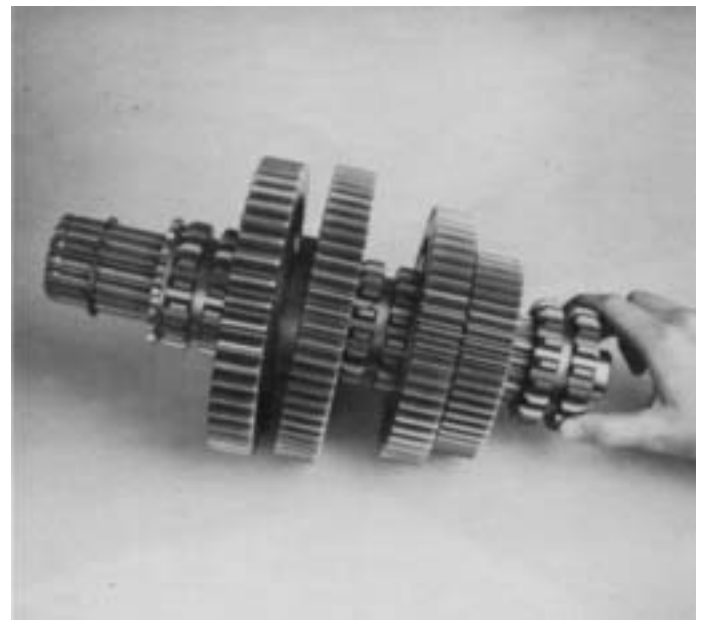

2. Remove 3rd-4th speed sliding clutch from front of mainshaft.

DISASSEMBLY-FRONT SECTION

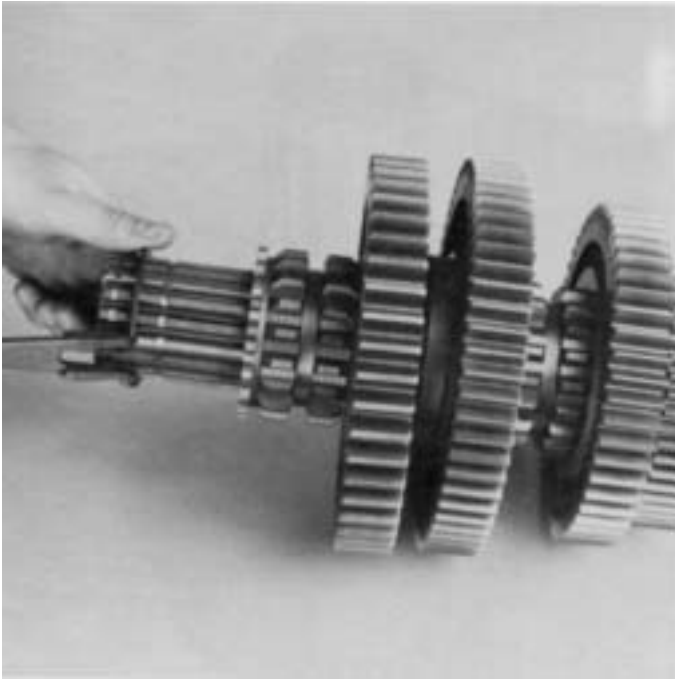

3. Remove snap ring from groove at rear of mainshaft.

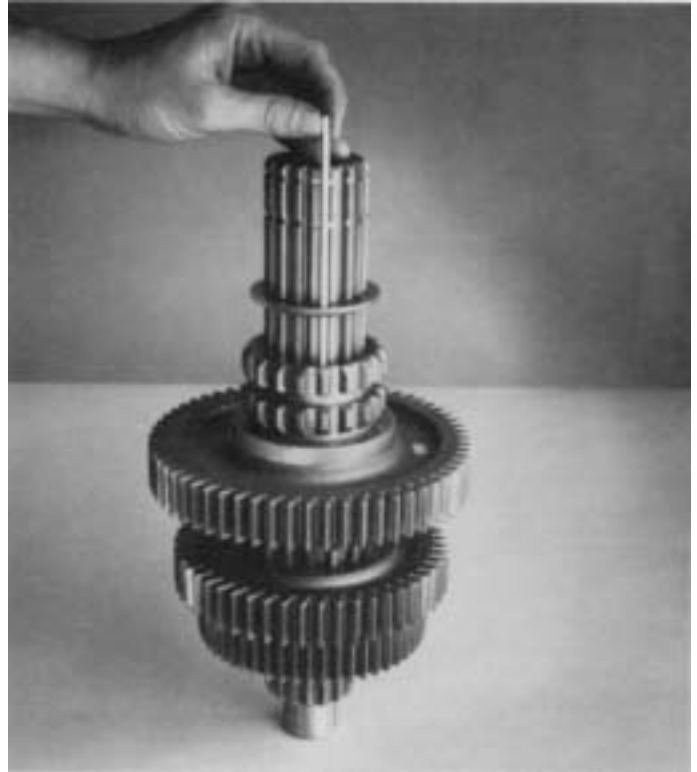

5. From rear of mainshaft, pull the key from mainshaft keyway.

NOTE: When removing limit washers, spacers and gears, note their location on mainshaft to facilitate reassembly. There is **ONLY** one limit washer and one spacer belonging to each gear.

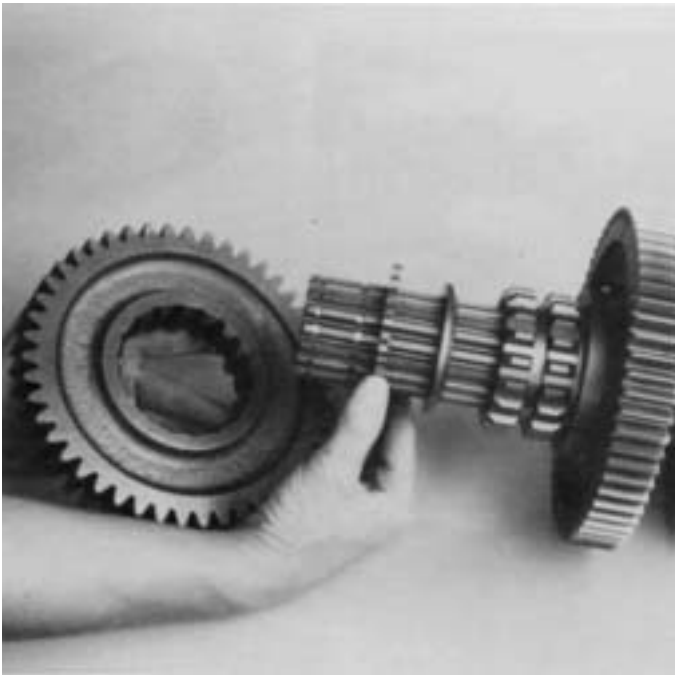

4. Remove reverse gear and spacer from rear of mainshaft.



6. Turn reverse gear limit washer to align its splines with those of mainshaft and remove washer.

DISASSEMBLY-FRONT SECTION

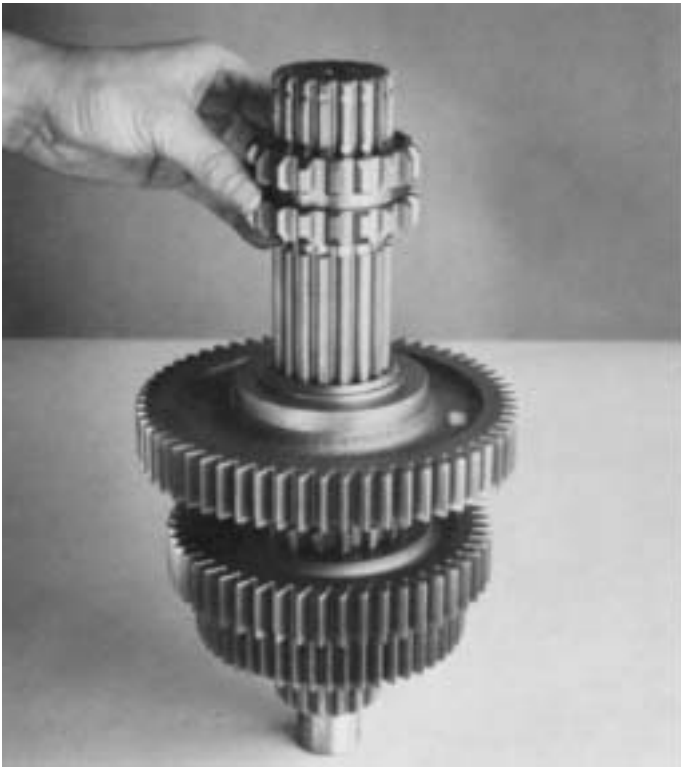

7. Remove Reverse speed sliding clutch from mainshaft.

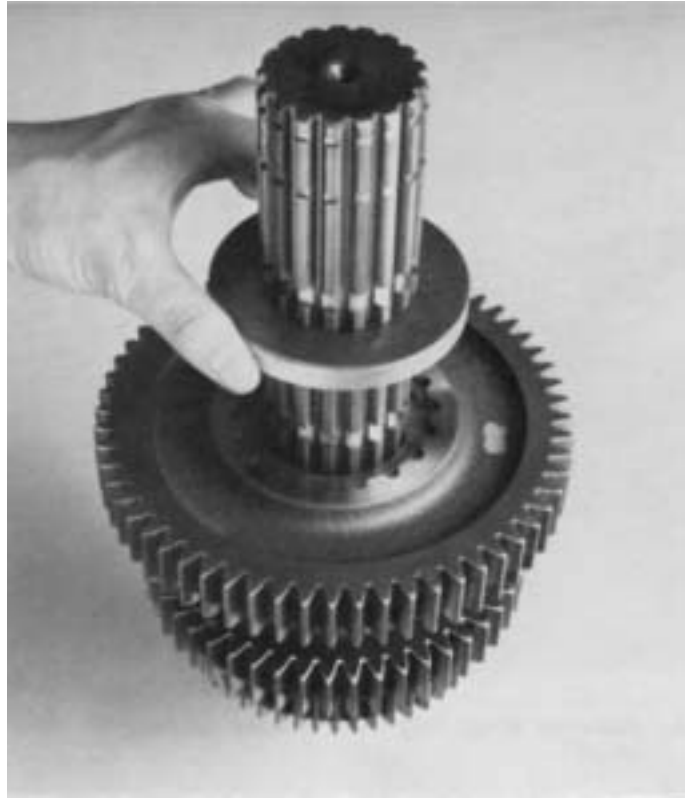

9. Remove spacer from mainshaft.

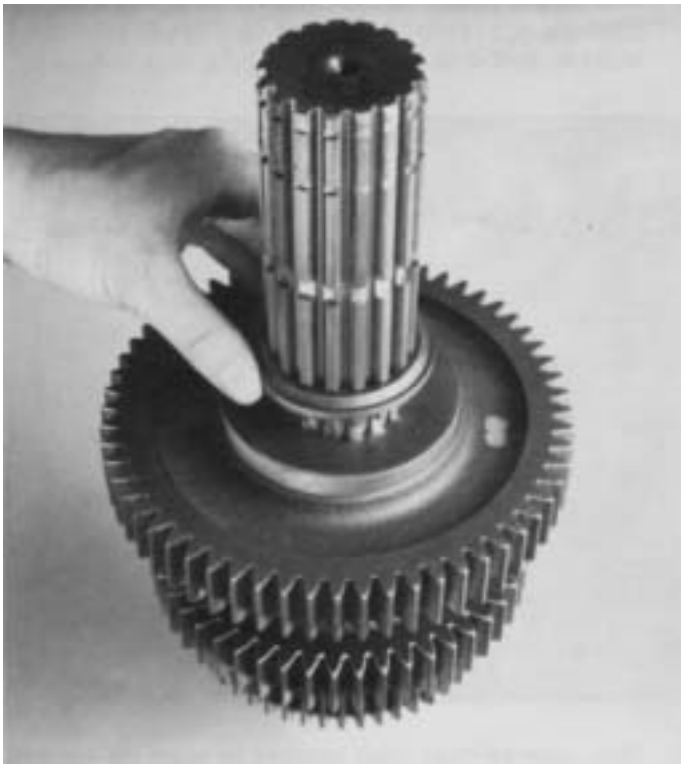

8. Using a small screwdriver, turn limit washer align its splines with those of mainshaft and move from rear of mainshaft.

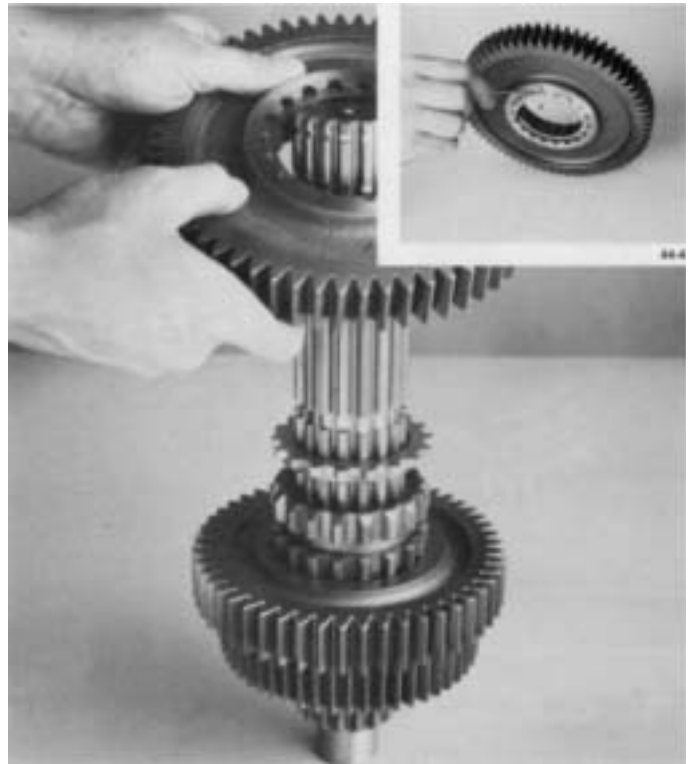

10. Remove 1st speed gear from rear of mainshaft. If necessary, remove the snap ring from I.D. of gear (inset).

DISASSEMBLY-FRONT SECTION

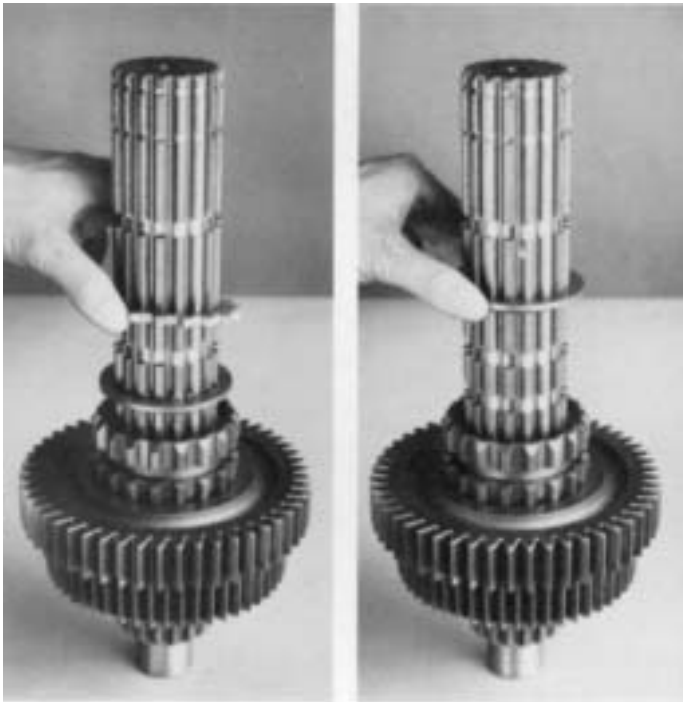

11. Remove spacer (left), rotate limit and limit washer (right) and remove from rear of mainshaft.

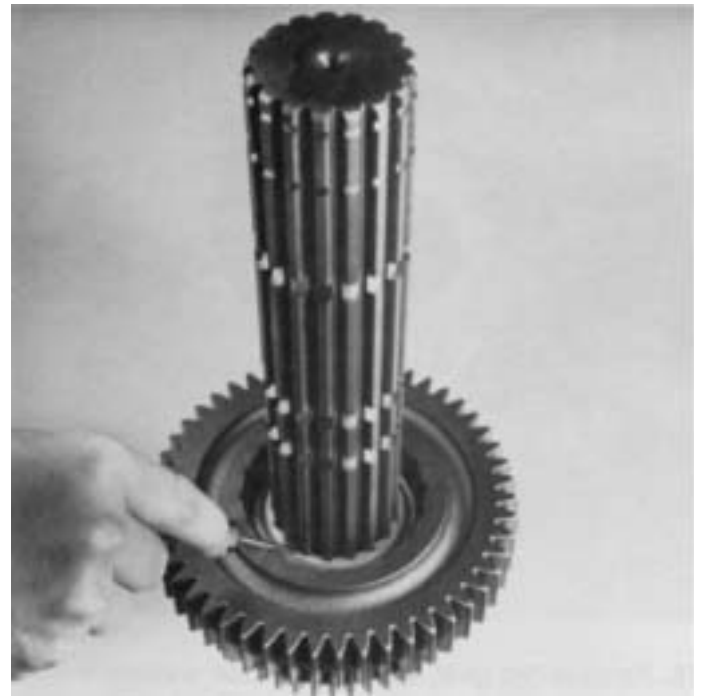

13. Using a small screwdriver, turn limit washer in hub of 2nd speed gear to align its splines with those of the mainshaft.

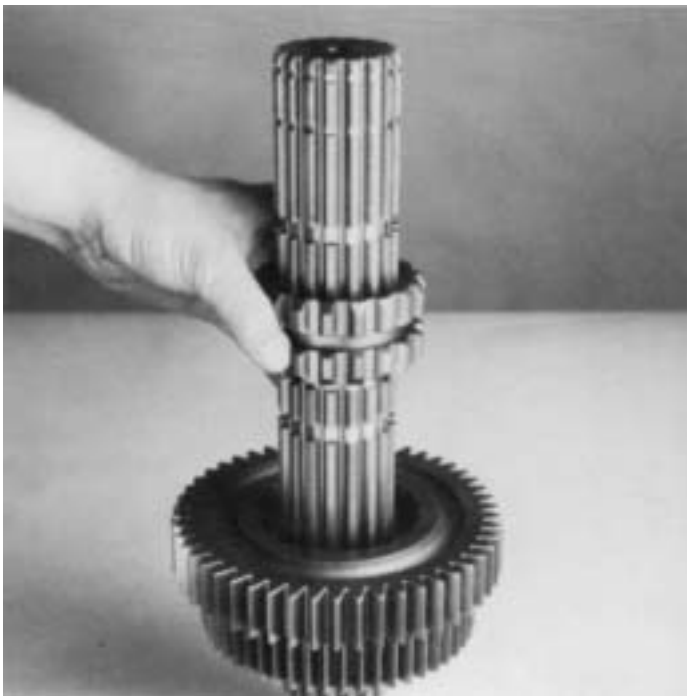

12. Remove 1st-2nd speed sliding clutch.



14. Lift 2nd speed gear from rear of mainshaft to remove limit washer, spacer, and gear. If necessary remove snap ring from I.D. of gear.

DISASSEMBLY-FRONT SECTION

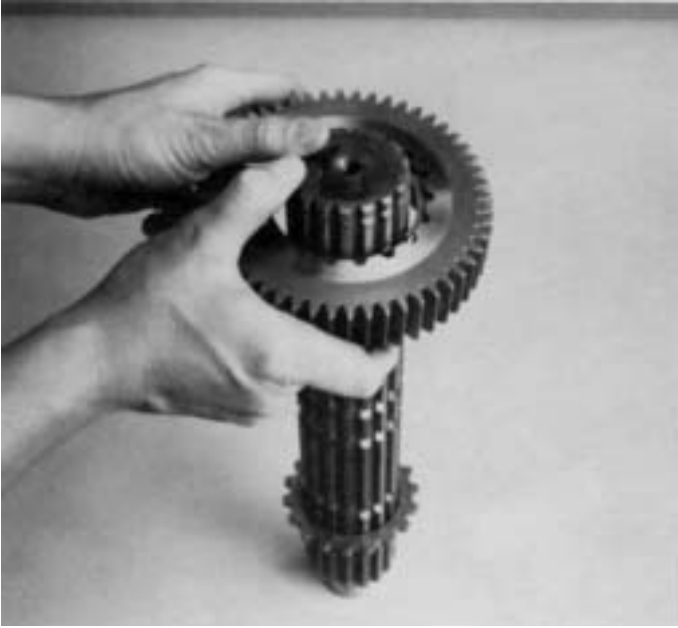

15. Remove 3rd gear, spacer, and limit washer. If necessary remove snap ring from I.D. of gear.

DISASSEMBLY - FRONT SECTION

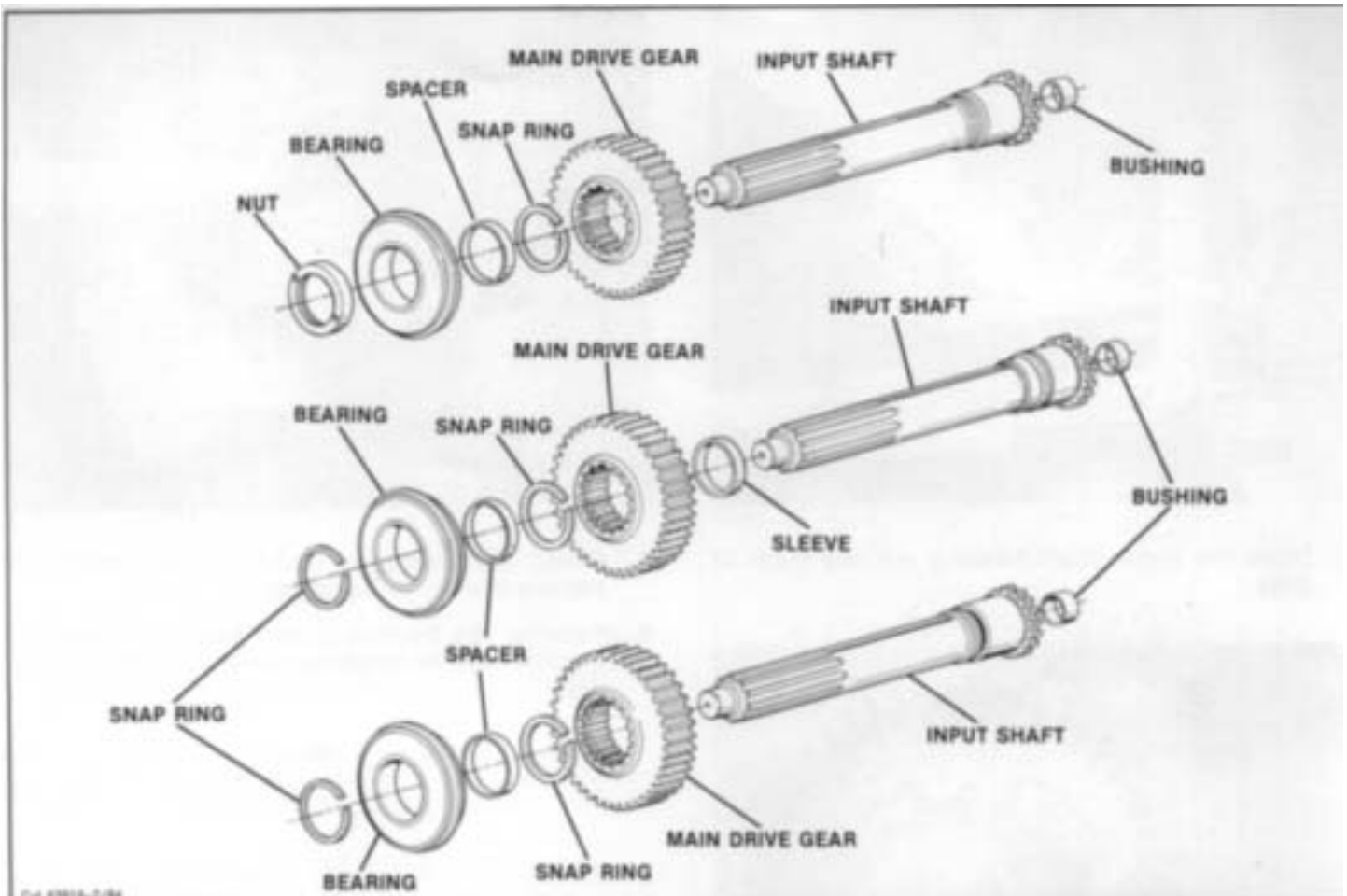

F. Removal and Disassembly of Main Drive Gear Assembly



1. Drive the input shaft back through bearing with a soft bar and maul. Remove input shaft from case (inset).



2. Move upper countershaft to right and remove drive gear and spacer from case.

DISASSEMBLY-FRONT SECTION

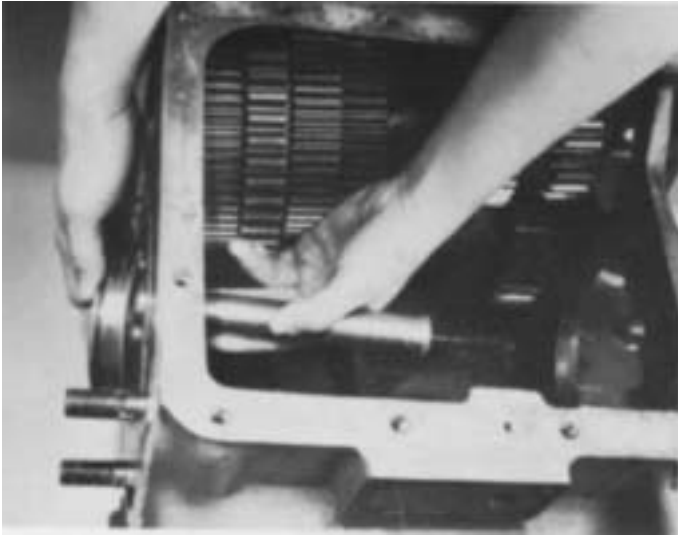

3. Drive the input shaft bearing out the front of case.



5. Check the bushing in pocket of input shaft and replace if worn or damaged.
6. Remove the front and rear bearings from left countershaft as described in Part D of this section.



4. If necessary, remove the snap ring from drive gear.

DISASSEMBLY-FRONT SECTION

G. Removal and Disassembly of Countershaft Assemblies

NOTE: Refer to the illustration provided at Part D of this section. Except for the PTO gears, the left and right countershaft assemblies are identical and disassembled in the same manner.



1. Move the right countershaft assembly to the rear as far as possible so front of shaft can be removed from case bore and moved to the center of case. Lift the assembly from case and repeat the procedure for left countershaft assembly.

NOTE: The left and right reverse idler gear assemblies are identical and disassembled in the same manner. If removal and disassembly of this assembly is necessary, refer to Part B of this section.



3. Remove the drive gear retaining snap ring from front of each countershaft.

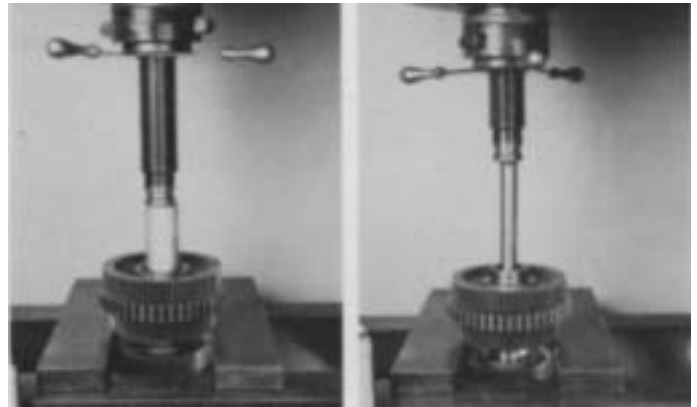

3. Using the rear face of 4th speed gear as a base, press the drive gear, PTO gear and 4th speed (or overdrive) gear from each countershaft (left). This will also remove the front bearing inner race from countershaft of models so equipped (right). **IMPORTANT:** NEVER USE THE PTO GEAR AS A PRESSING BASE. The narrow face width of this gear makes it very susceptible to breakage.



4. Using the rear face of 2nd speed gear as a base, press the 3rd speed and 2nd speed gears from each countershaft.

NOTE: Always use caution when pressing a cluster of gears from countershaft. It is necessary to press these gears off in a cluster of three and, then, in a cluster of two.

DISASSEMBLY-FRONT SECTION



5. If necessary, remove key from countershaft.

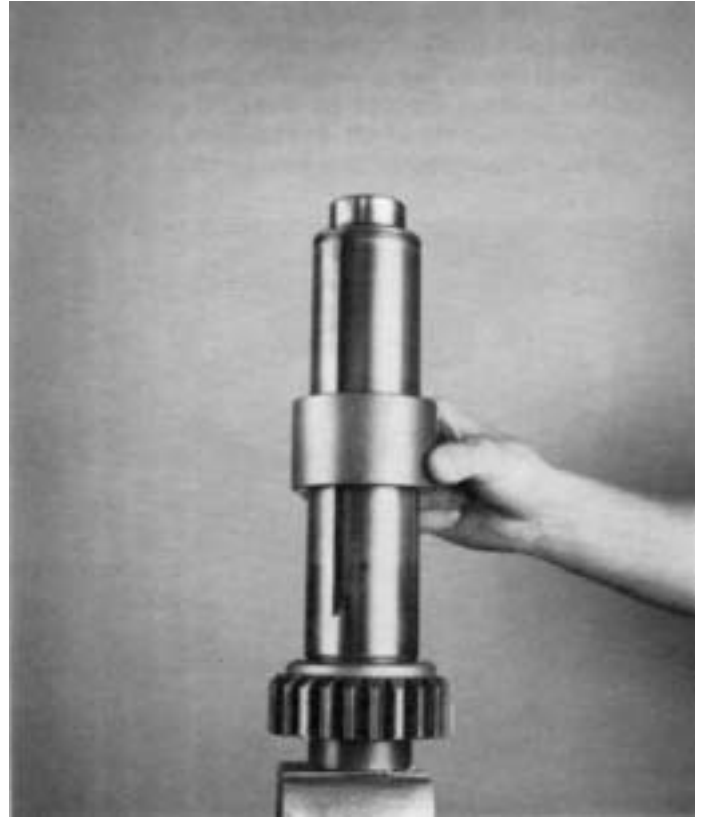

6. If necessary, remove spacer.

REASSEMBLY-FRONT SECTION

CASE ASSEMBLIES

NOTE: Before starting reassembly, make sure the three magnetic discs are solidly in place at bottom of case. These can be secured to disc mounting surfaces with Scotch Grip Rubber Adhesive or equivalent adhesive.

A. Reassembly and Installation of Right Reverse Idler Gear Assembly

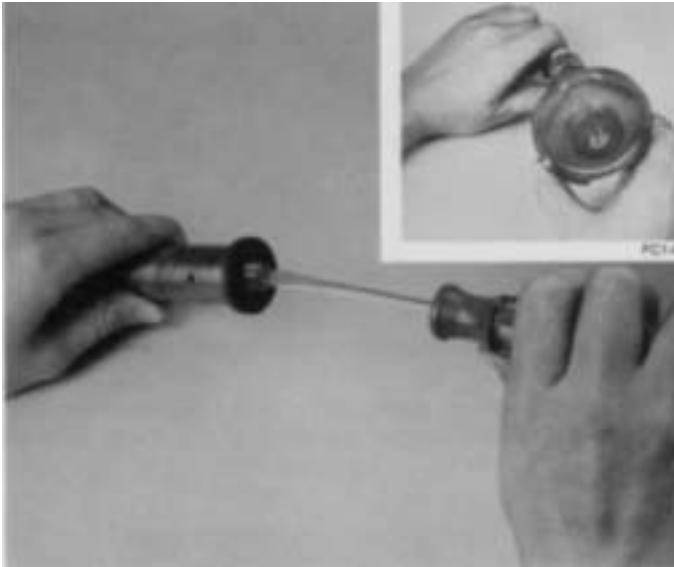

1. If previously removed, thread pipe plug in rear of reverse idler shaft and tighten. Install the washer on shaft, flat side to the front (inset).

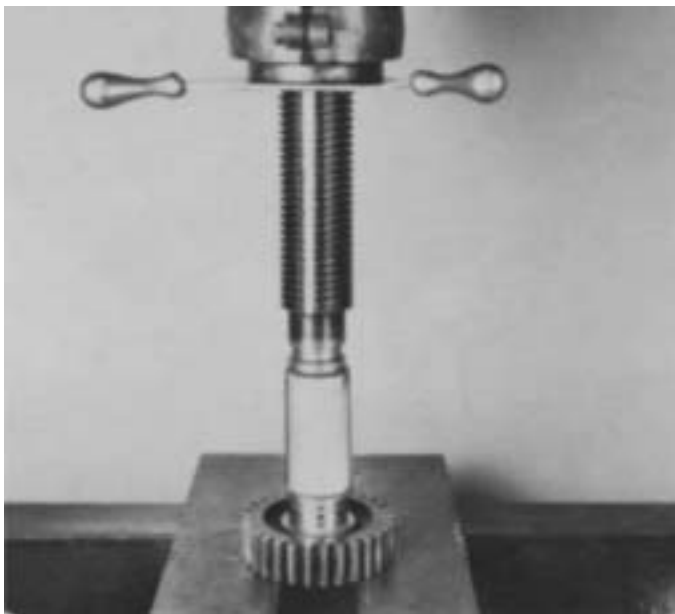

2. If previously removed, press the needle bearing into bore of reverse idler gear.

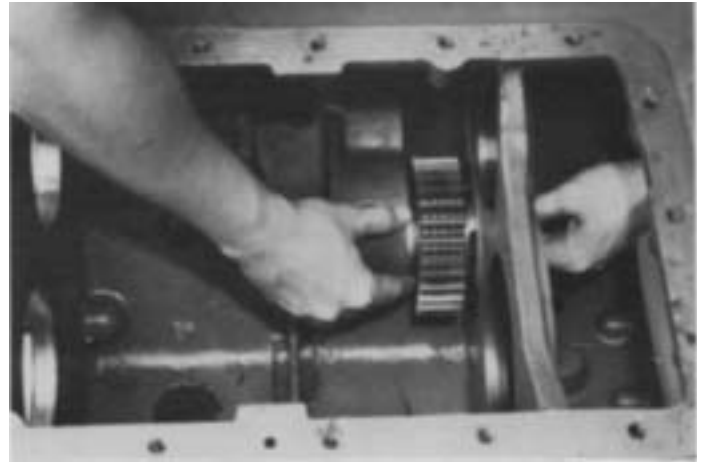

3. Install the bearing inner race on idler shaft and insert shaft into case bore, threaded-end of shaft to the front. As the idler shaft is moved forward, install the reverse idler gear on shaft, long hub to the front and seating on bearing inner race. Position the thrust washer on shaft between the gear and support boss in case and continue with movement of idler shaft forward into bore of support boss.

REASSEMBLY-FRONT SECTION

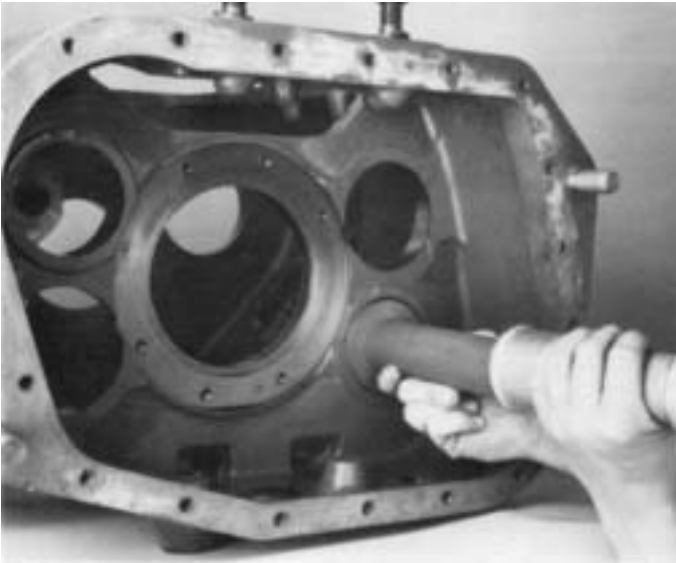

5. Install OUTER RACE of auxiliary countershaft front bearing into case bore and against retaining washer.
NOTE: The bearing INNER RACE is installed on front of auxiliary countershaft and never with outer race.

B. Reassembly of Countershaft Assemblies

NOTE: Except for PTO gears, the left and right countershaft assemblies are identical and reassembled in the same manner.

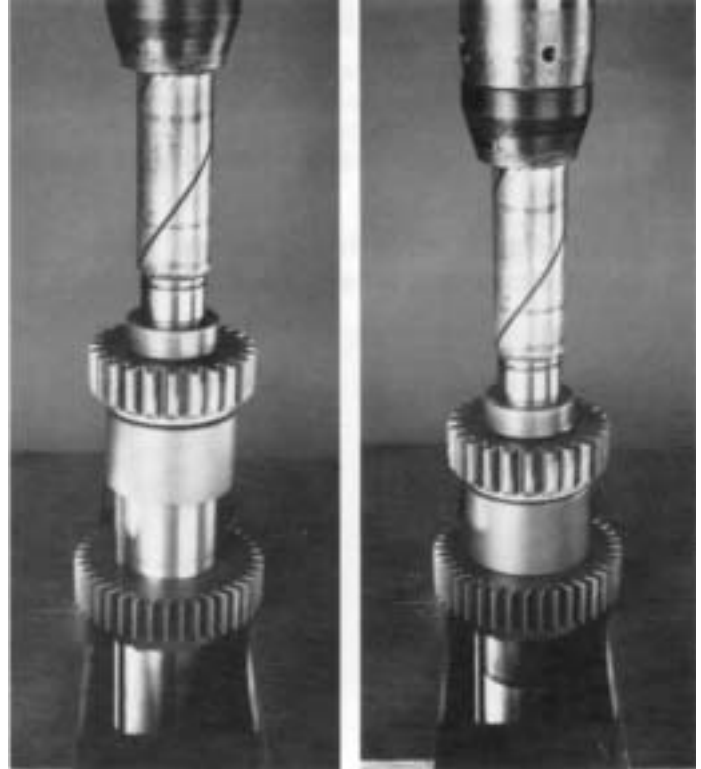

2. Align keyway of gear with key in countershaft and press the 1st speed gear on shaft, long hub of gear to the front of countershaft.

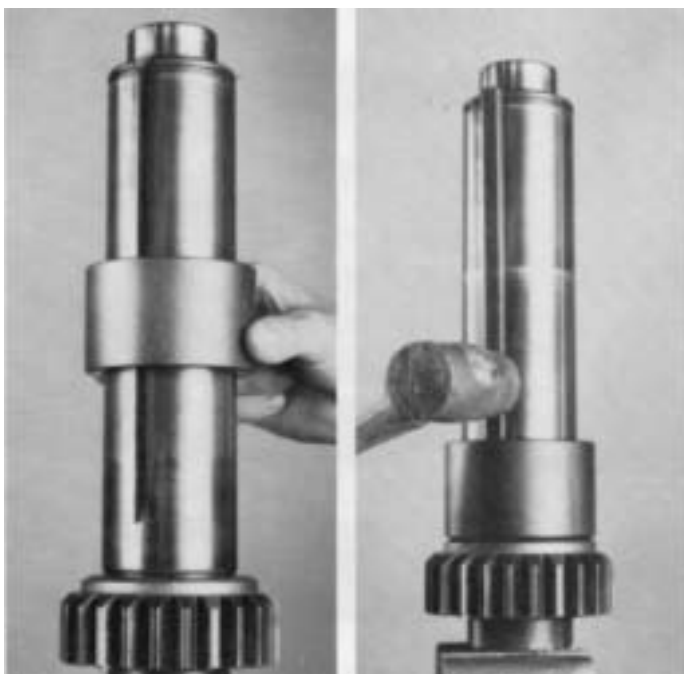

1. If previously removed, install the spacer (left) and key in keyway of countershaft (right).

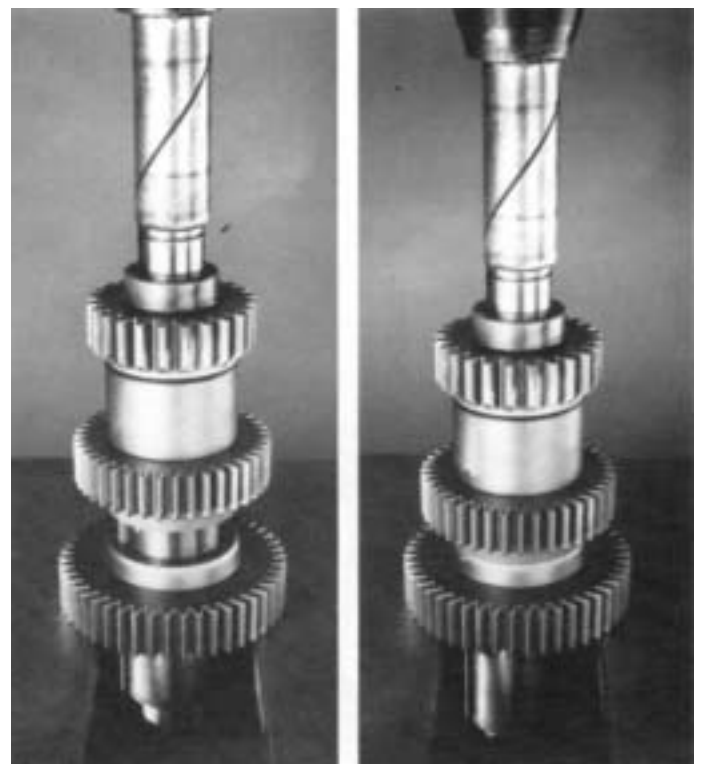

3. Press 2nd speed gear on countershaft, long hub of gear against 1st speed gear hub.

REASSEMBLY-FRONT SECTION

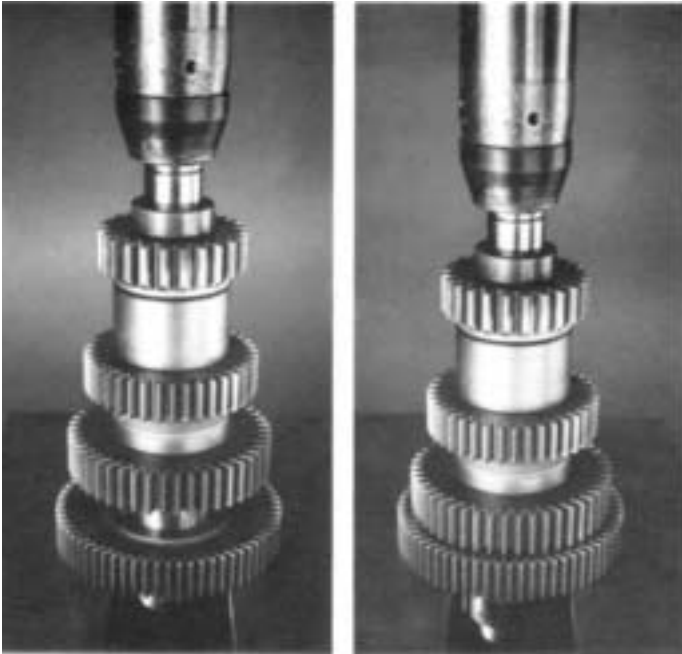

4. Press 3rd speed gear on countershaft, long hub of gear to front of shaft.

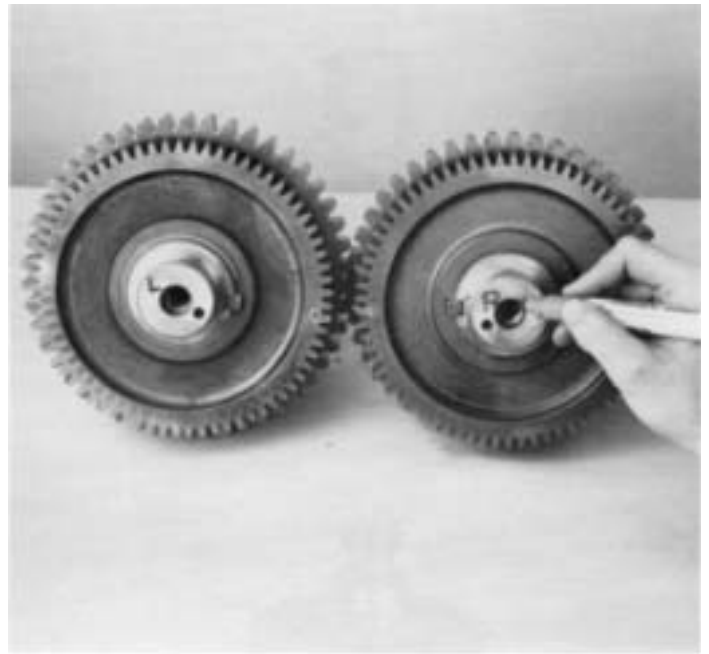

6. To avoid confusion during installation, mark end of left countershaft with an "L"; the end of right countershaft with an "R".

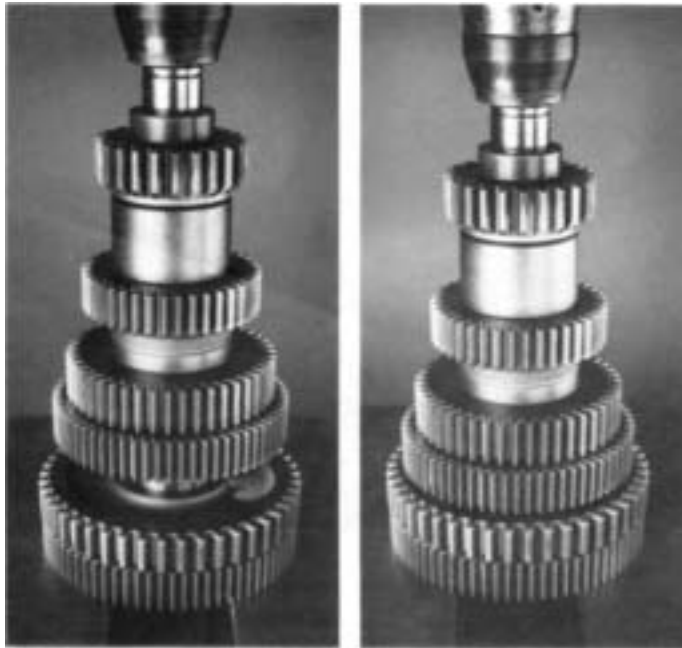

5. Start the PTO gear onto countershaft, bullet-nose side of teeth facing up and toward rear of shaft. Align keyway of drive gear with key in countershaft and press BOTH gears onto shaft, long hub of drive gear against PTO gear.
NOTE: The left countershaft assembly has a 47-tooth PTO gear; the right countershaft assembly has a 45-tooth PTO gear.



7. Install drive gear retaining snap ring in groove on front of each countershaft.

REASSEMBLY-FRONT SECTION



8. For models equipped with roller-type front bearings, use a rubber mallet or flanged-end driver to install bearing inner race on shaft, shoulder of race against shoulder of countershaft.

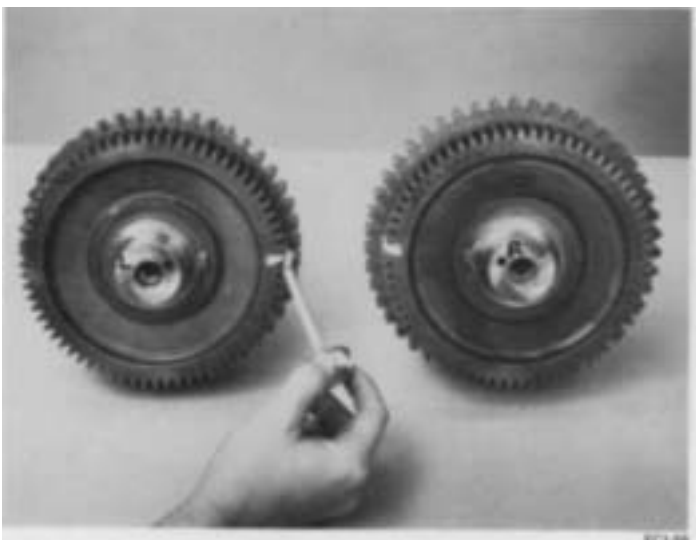

IMPORTANT: Mark the countershaft drive gear for timing purposes. On the drive gear of each countershaft assembly, mark the tooth aligned with keyway of gear and stamped with an "O" for easy identification. A highly visible color of toolmakers' dye is recommended for making timing marks.

C. Partial Installation of Countershaft Assemblies

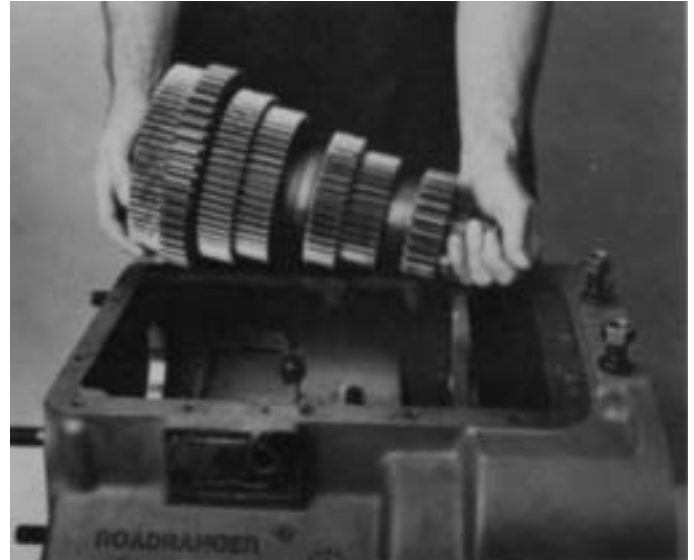

1. Place the left countershaft assembly into position in case, making sure that the "L"-marked assembly has the larger 47-tooth PTO gear.

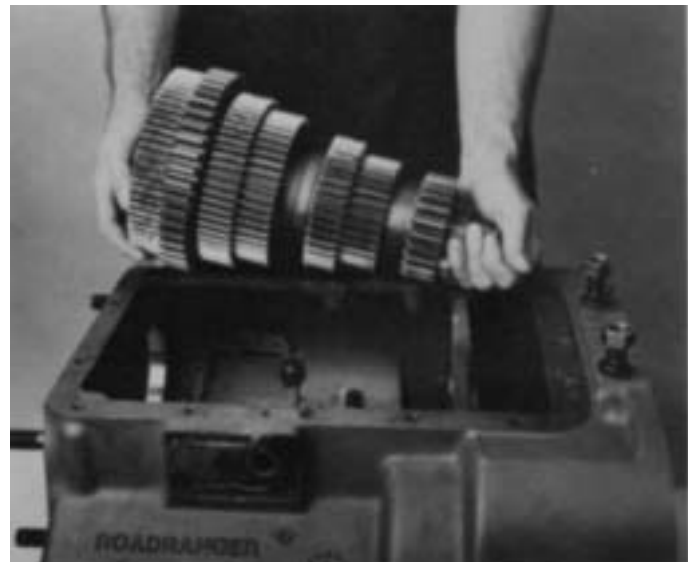

2. Place the right countershaft assembly into position in case, making sure that the "R"-marked assembly has the smaller 45-tooth PTO gear.

REASSEMBLY-FRONT SECTION

D. Bearing Installation of Left Countershaft Assembly



1. Move the left countershaft assembly to the rear and insert countershaft support tool or blocking to center shaft in rear case bore.



2. Use a flanged-end bearing driver to start the bearing in case bore.
NOTE: The inner race of roller-type front bearing is pressed on front of countershaft.



3. Center the front of left countershaft in bearing and move the assembly forward.



4. Use a flanged-end bearing driver to completely seat front bearing or bearing outer race in case bore.

REASSEMBLY-FRONT SECTION



5. Position the retainer plate on front of left countershaft, roll pin in hole at end of shaft, and secure with capscrew tightening to recommended torque ratings.



6. Remove countershaft support tool or blocking from rear case bore and install the left countershaft rear bearing with larger I.D. lead chamfer to the front of shaft and install the snap ring in groove at rear of left countershaft.

REASSEMBLY-FRONT SECTION

E. Reassembly, Installation and Timing of Main Drive Gear Assembly

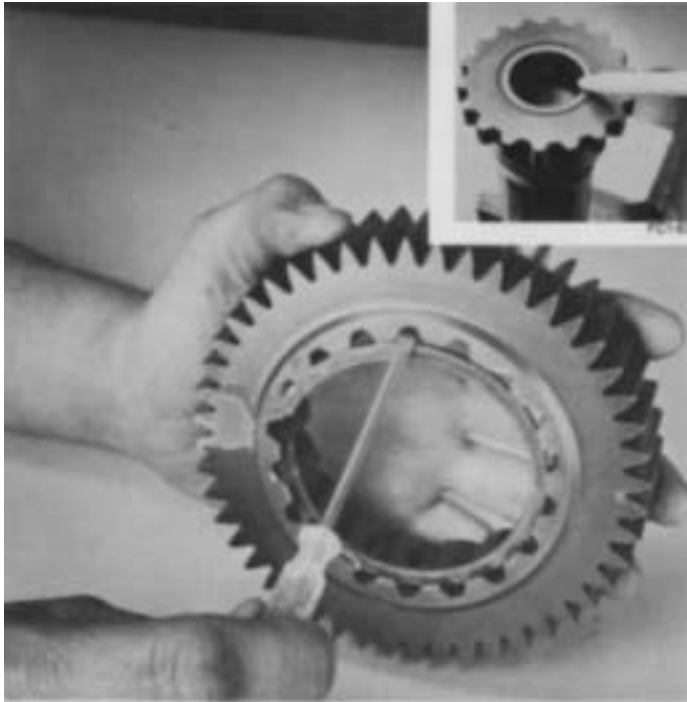

1. If previously removed, install the snap ring in I.D. of main drive gear and the bushing in pocket of input shaft (inset).



2. Mark the main drive gear for timing purposes. Mark any two adjacent teeth on drive gear and repeat the procedure for the two adjacent teeth directly opposite the first set marked. A highly visible color of toolmakers' dye is recommended for making timing marks.

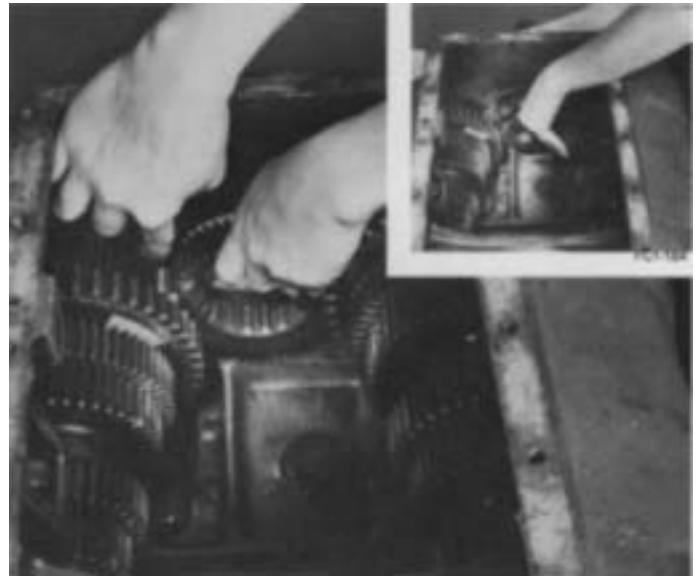

3. Mesh the marked tooth of left countershaft drive gear with either set of two marked teeth on main drive gear. Slide the input shaft through the main drive gear (inset).



4. Install spacer (inset) and bearing on the input shaft with external snap ring to the outside.

REASSEMBLY-FRONT SECTION



5. Tap the bearing into position in the bore with a soft mallet.

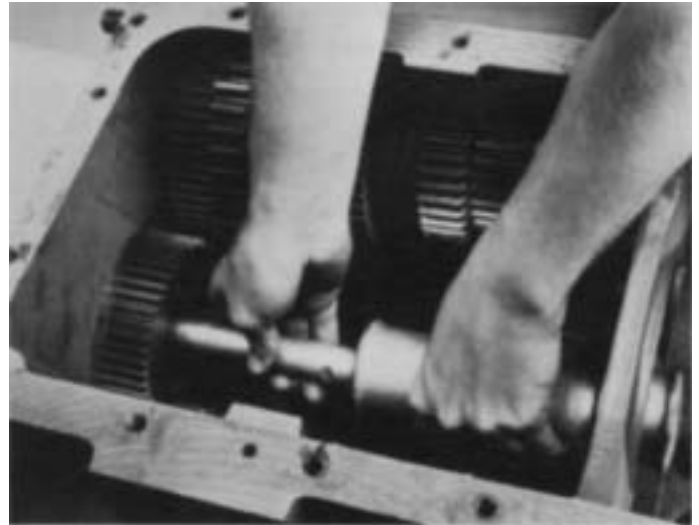

7. Use a soft bar and maul to drive the input shaft through bearing. Remove front bearing cover.

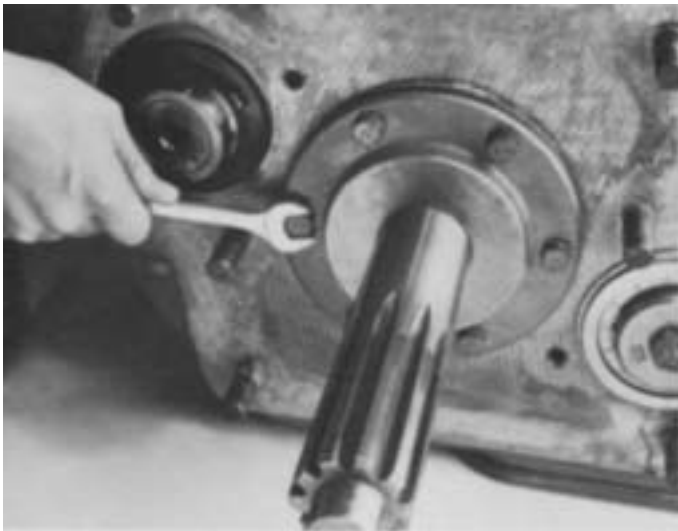

6. Temporarily install the front bearing cover.

F. Reassembly of Auxiliary Drive Gear Assembly

NOTE: Because the auxiliary drive gear assembly is used in checking reverse gear axial clearances and centering mainshaft in rear bearing bore during Reassembly and Partial Installation of Mainshaft Assembly, it is necessary to complete the following instructions **BEFORE** proceeding to Part G.



1. If previously removed, install the O-rings on extended front hub of auxiliary drive gear.

REASSEMBLY - FRONT SECTION

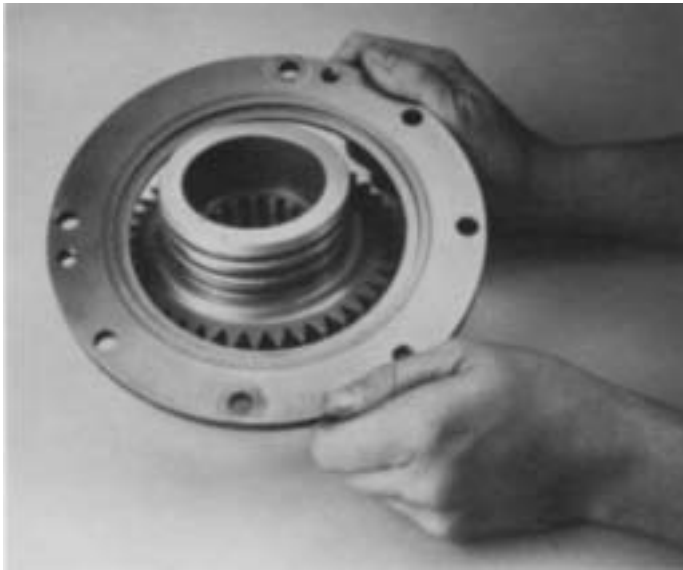

2. Install the retainer ring on auxiliary drive gear, snap ring groove facing front hub and away from gear teeth.



4. Install the snap ring in groove of front gear hub to retain bearing.

G. Reassembly and Partial Installation of Mainshaft Assembly

1. If previously removed, install the corresponding snap rings in I.D. of mainshaft gears.



3. Start the auxiliary drive gear bearing on front hub, bearing snap ring facing groove in retainer ring. Using both the inner and outer race of bearing as a base, press the bearing on gear with snap ring in groove of retainer ring or use a bearing driver (inset).

REASSEMBLY-FRONT SECTION

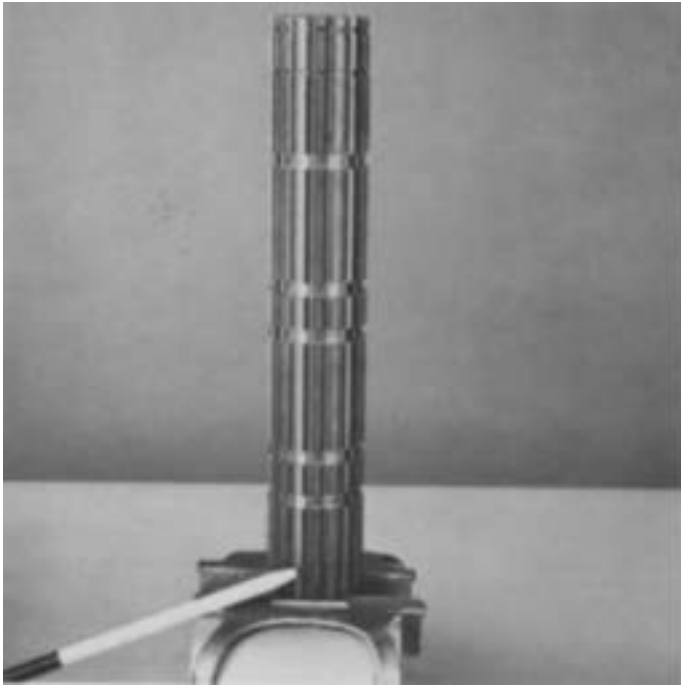

2. Secure the mainshaft in a vise equipped with brass jaws or wood blocks, pilot-end of shaft down. If previously removed, install the roll pin in keyway.

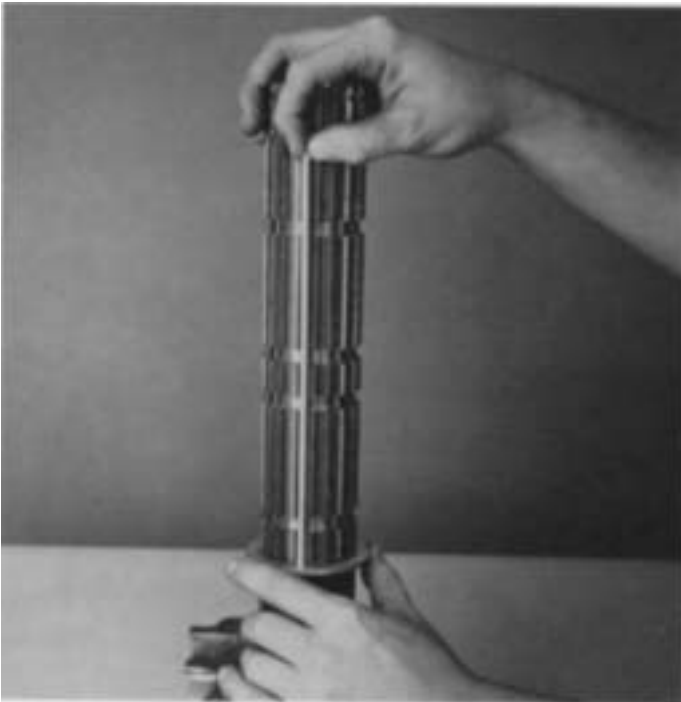

3. Install the 4th speed gear limit washer on mainshaft, flat side of washer up. Rotate washer in the 1st or bottom groove of mainshaft to align the splines of washer with those of the mainshaft. install the key in mainshaft keyway to lock washer in place.

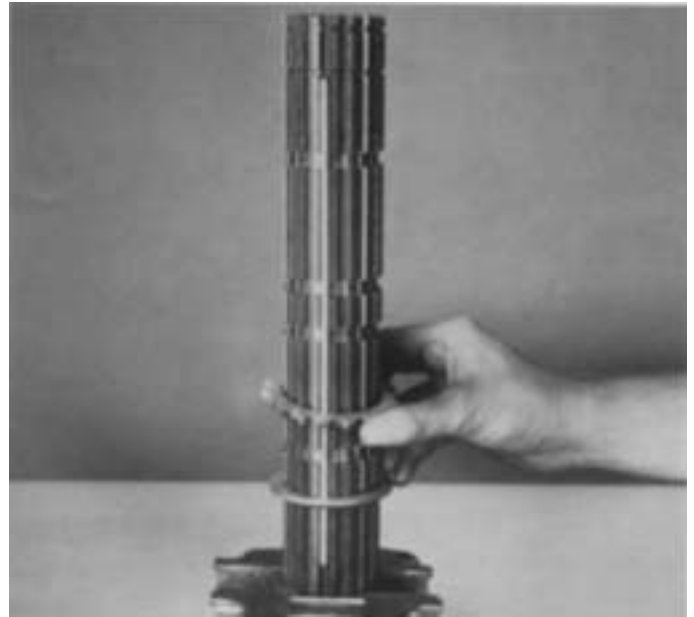

4. Install the spacer on shaft against washer.

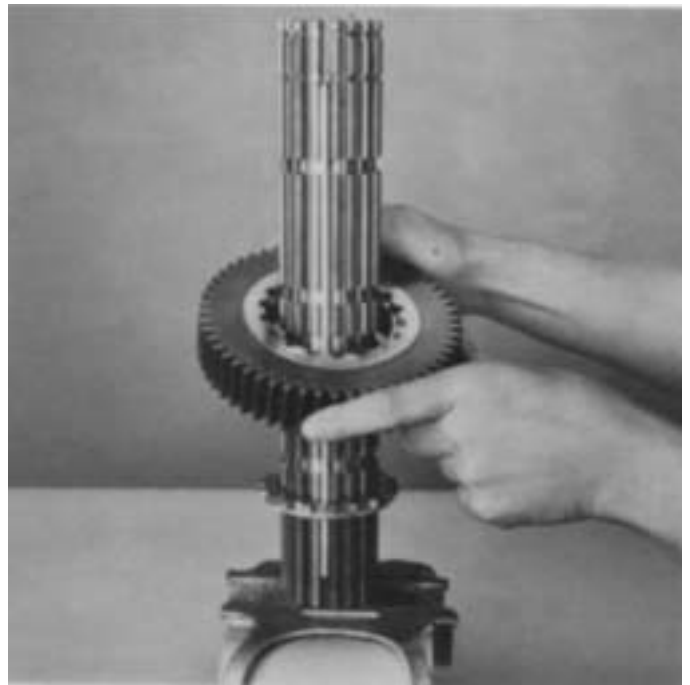

5. Install the 4th speed (or Overdrive) gear on mainshaft, clutching teeth down and engaged with external splines of spacer.

NOTE: Gear limit washers are internally splined and locked to mainshaft by the key. Gear spacers are externally splined to engage with clutching teeth in gear hubs. There is one limit washer and one spacer for each gear in the mainshaft assembly.

REASSEMBLY-FRONT SECTION

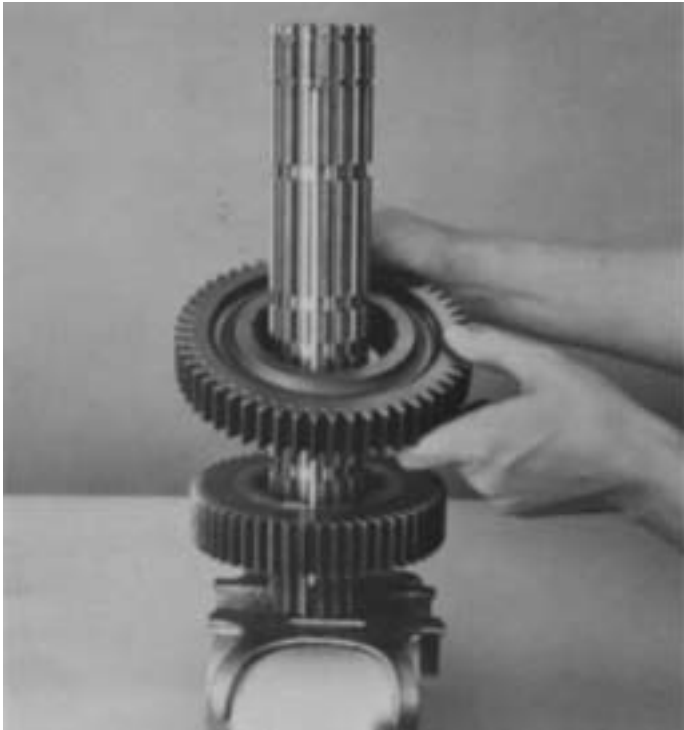

6. Install the 3rd speed gear on shaft against 4th speed (or Overdrive) gear, clutching teeth up.

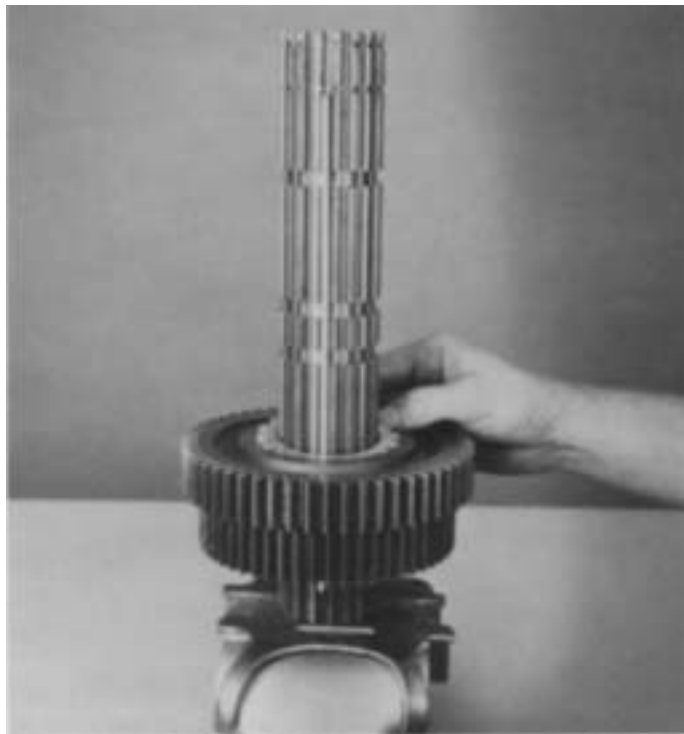

7. Install the spacer in 3rd speed gear, engaging the external splines of spacer with clutching teeth of gear.

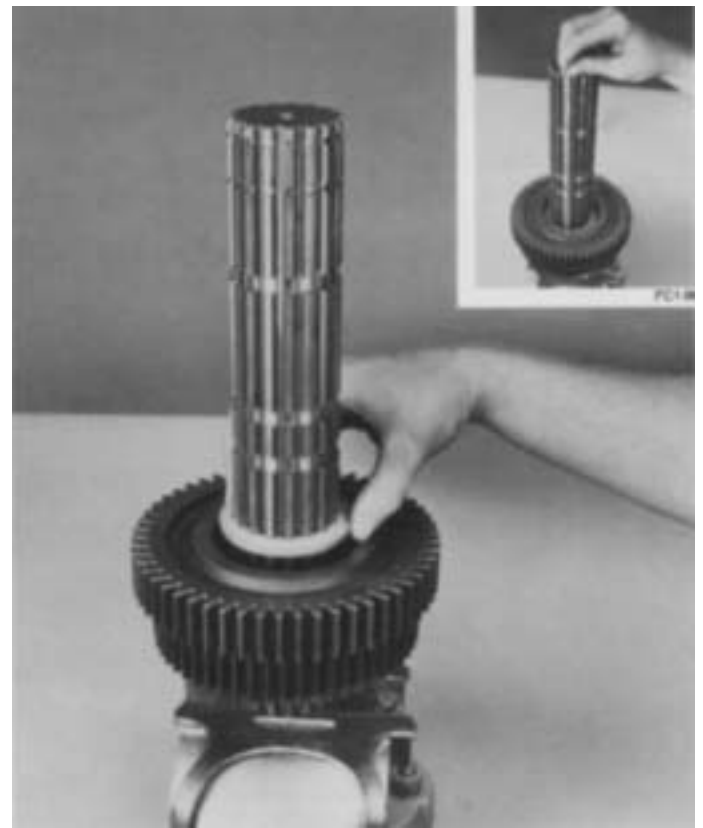

8. Remove the key from keyway and install the 3rd speed gear limit washer on mainshaft, flat side of washer down and against spacer. Rotate washer in the 2nd groove of mainshaft to align the splines of washer with those of the mainshaft and reinsert key in keyway to lock washer in place (inset).

REASSEMBLY-FRONT SECTION

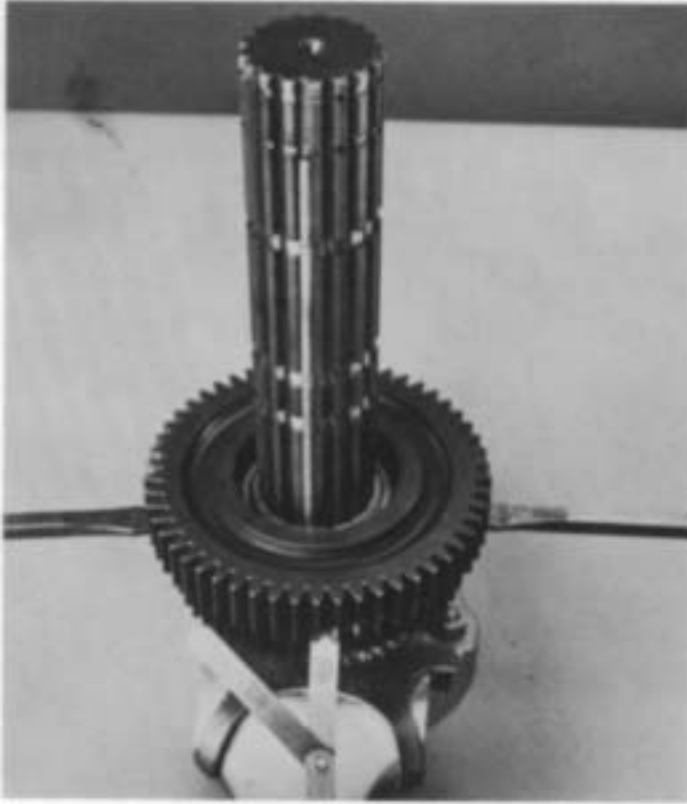

10. Install the 2nd-3rd speed sliding clutch, aligning the missing internal spline of sliding clutch with key in mainshaft.

9. Insert two large screwdrivers between the 3rd and 4th speed (or Overdrive) gears to check axial clearances. Apply slight downward pressure on screwdriver handles to spread gears evenly. Making sure the gear hubs are parallel, insert a feeler gage between hubs. Correct axial clearance should be from .005" to .012". If the clearance is less than the minimum .005" tolerance, the limit washer in the 3rd speed gear should be replaced by a thinner limit washer. This will increase the axial clearance between the gears. If the clearance checked is greater than the maximum .012" tolerance, a thicker limit washer should be installed in the 3rd speed gear. This would decrease the axial clearance between the gears.

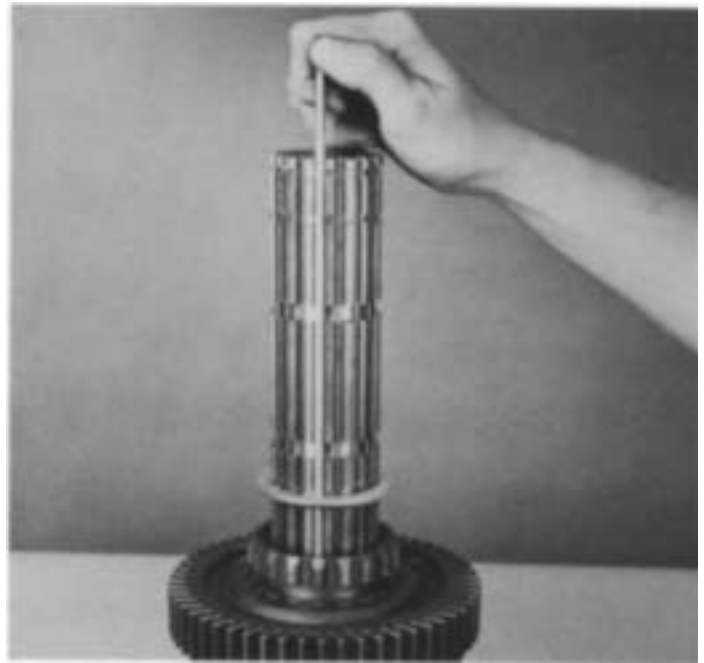

11. Remove the key from keyway and install the 2nd speed gear limit washer on mainshaft, flat side of washer up. Rotate washer in the 3rd groove of mainshaft to align the splines of washer with those of the mainshaft and reinsert key in keyway to lock washer in place.

REASSEMBLY—FRONT SECTION

SETTING CORRECT AXIAL CLEARANCES FOR MAINSHAFT GEARS

Axial Clearance (End-Play) Limits Are:
 .005"-.012" for all mainshaft gears

Washers are used to obtain the correct limits; six thicknesses are available as follows:

LIMITS (INCH)	COLOR CODE
.248 -.250	WHITE
.253 -.255	GREEN
.258-.260	ORANGE
.263 -.265	PURPLE
.268-.270	YELLOW
.273 -.275	BLACK
*	"PLUS RED"

***NOTE:** New style limit washers come in a full range of tolerances as corresponding colors listed above "plus red." (Example: "Orange plus red" limit washer has an inch limit thickness of .258-.260.)

Refer to Illustrated Parts Lists for washer part numbers.

Always use the .248-.250" low limit washer ("White" or "white plus red") in the 1st and 3rd speed gear positions as shown at right.

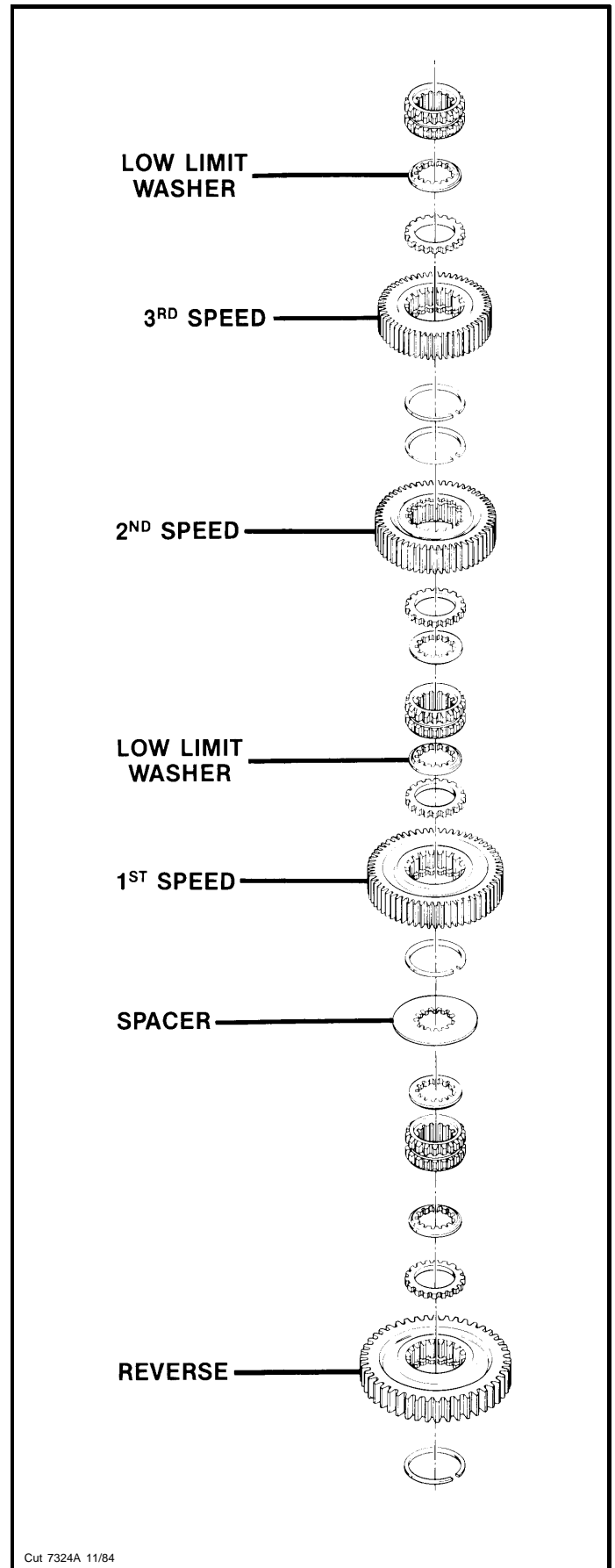

REASSEMBLY-FRONT SECTION

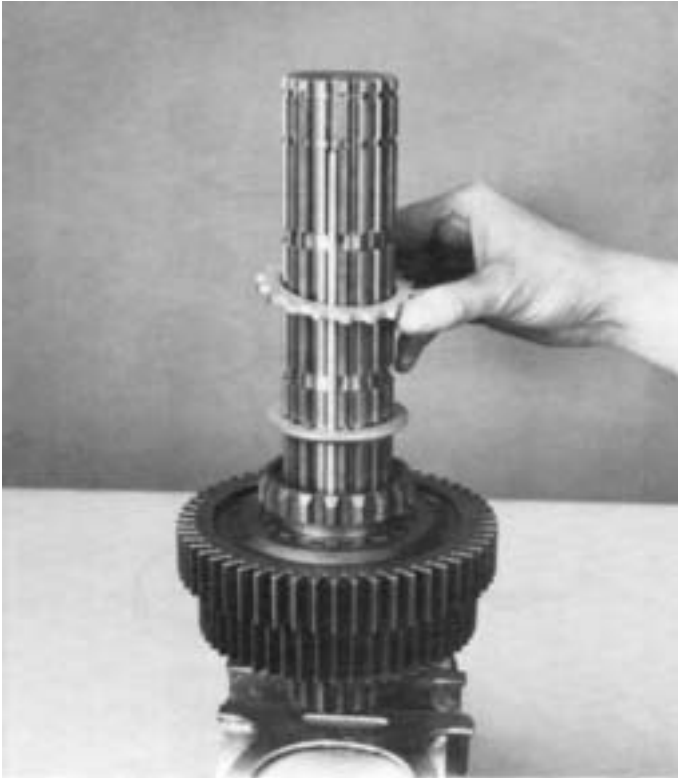

12. Install spacer on shaft against washer.

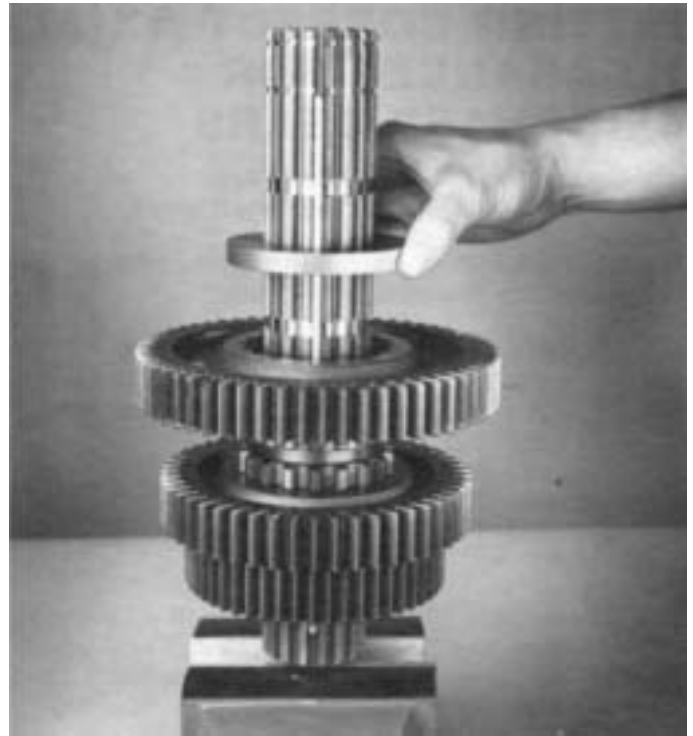

14. Install spacer on shaft against 1st speed gear.

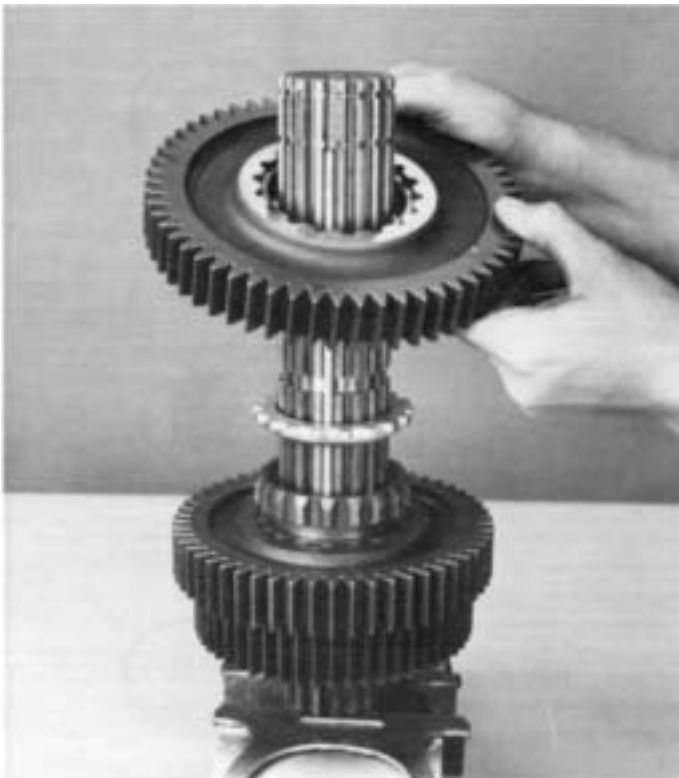

13. Install 1st speed gear on mainshaft, clutching teeth down and engaged with external splines of spacer.

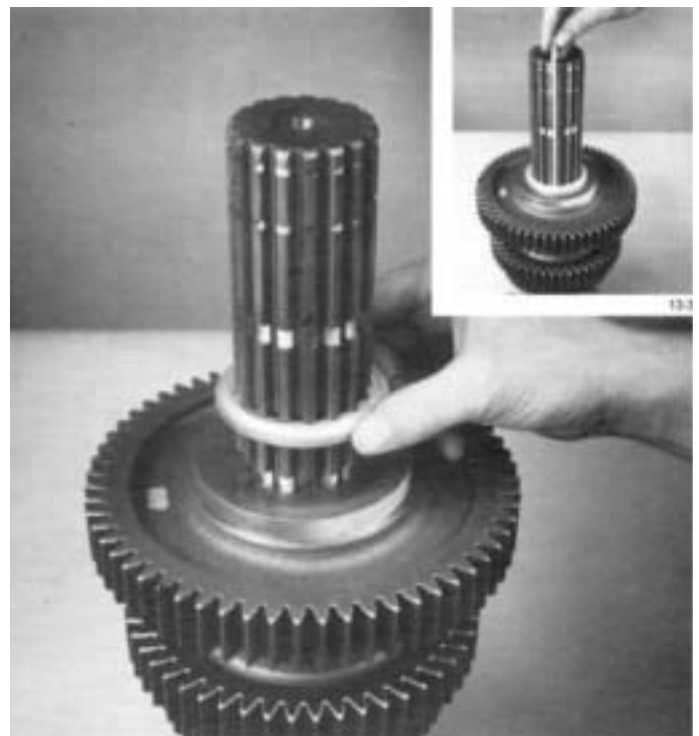

15. Remove key from keyway and install spacer limit washer on mainshaft, flat side of washer down and against spacer. Rotate washer in 4th groove of mainshaft to align splines of washer with those of mainshaft and reinsert key in keyway to lock washer in place (inset).

REASSEMBLY-FRONT SECTION

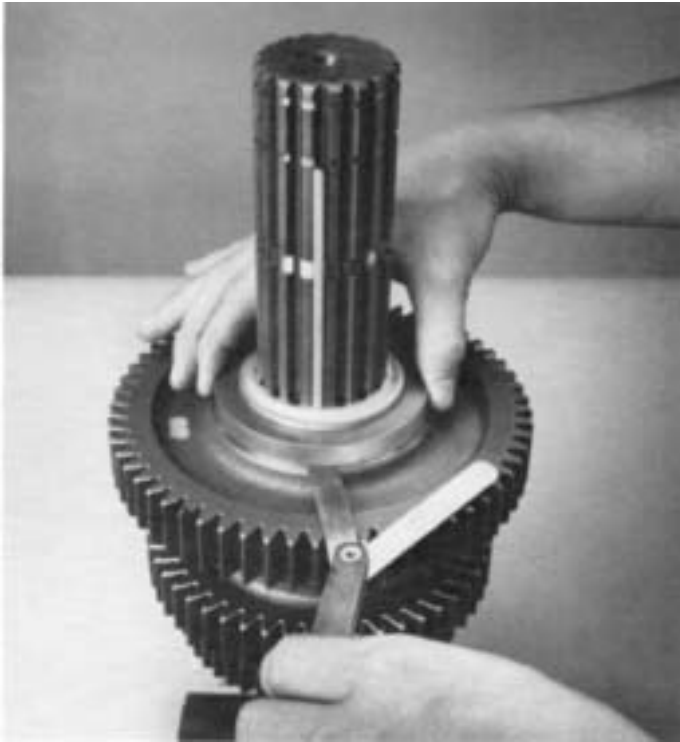

16. Pull up evenly on spacer and check axial clearance between 1st speed gear and spacer. If necessary make adjustments as described in No. 9 of this section.

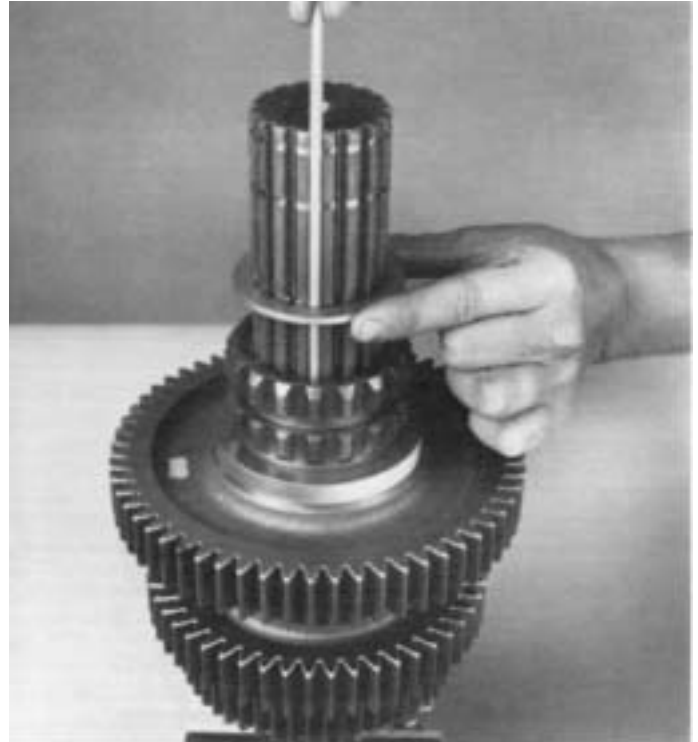

18. Remove key from keyway and install reverse gear limit washer on mainshaft, flat side of washer up. Rotate washer in 5th groove of mainshaft to align splines of washer with those of mainshaft. Reinsert key in keyway to lock washer in place.

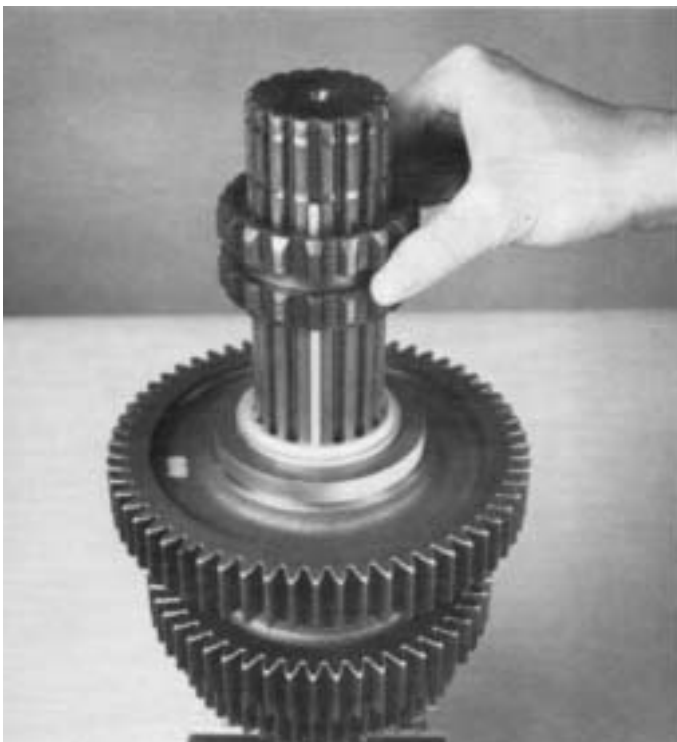

17. Install Reverse speed sliding clutch, aligning missing internal spline of sliding clutch with key in mainshaft.

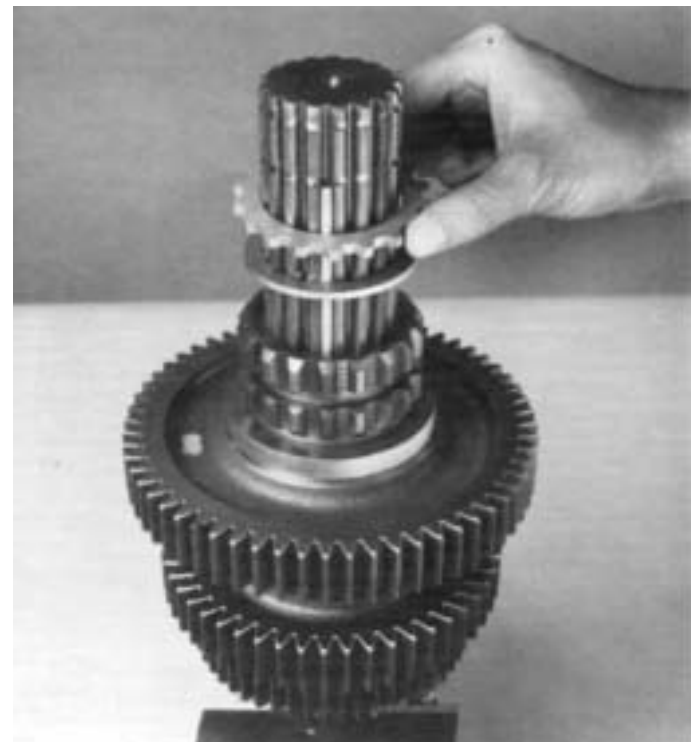

19. Install spacer on shaft against washer.

REASSEMBLY-FRONT SECTION



20. Install snap ring in 6th groove of mainshaft to retain key in keyway.



22. Install reverse gear on mainshaft, clutching teeth down and engaged with external splines of spacer.



21. Install snap ring in hub of reverse gear ONLY TO CHECK AXIAL CLEARANCE (END-PLAY) LIMITS.

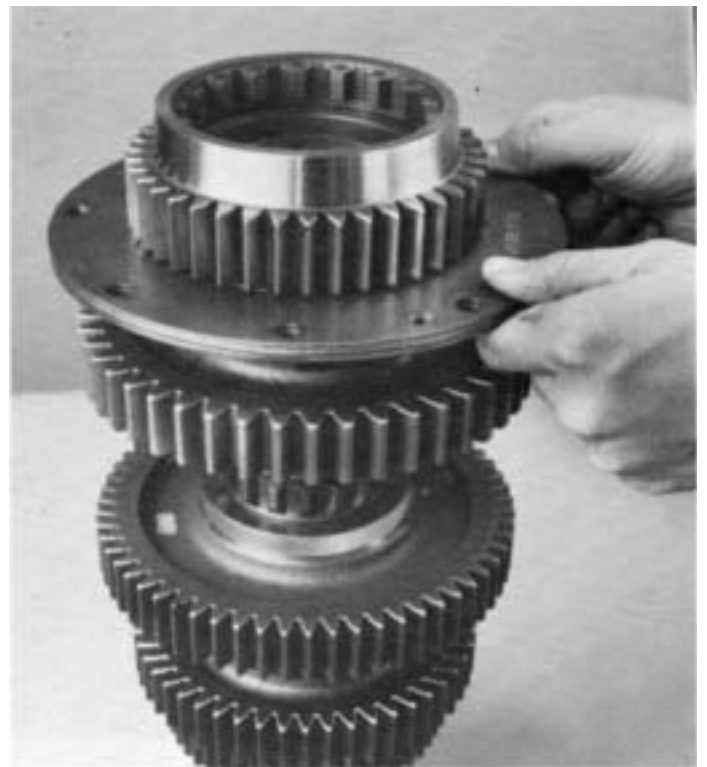

23. Install the auxiliary drive gear assembly in its proper position on rear of mainshaft.

REASSEMBLY-FRONT SECTION



24. Force both the reverse gear and auxiliary drive gear downward on the shaft to flatten their respective snap rings. Making sure the gear hubs are parallel, insert a feeler gage between the hubs of the reverse gear and auxiliary drive gear. Correct axial clearance should be from .005" to .012". If clearance is less than the minimum .005" tolerance, the reverse gear limit washer should be replaced by a thinner limit washer. This will increase the axial clearance between the gears. If the clearance checked is greater than the maximum .012" tolerance, a thicker limit washer should be installed in the reverse gear. This would decrease the axial clearance between the gears.

NOTE: THIS CHECK IS MADE WITHOUT SPREADING THE GEARS WITH SCREWDRIVERS.



25. With the proper reverse gear limit washer installed on mainshaft, remove the auxiliary drive gear assembly and reverse gear.

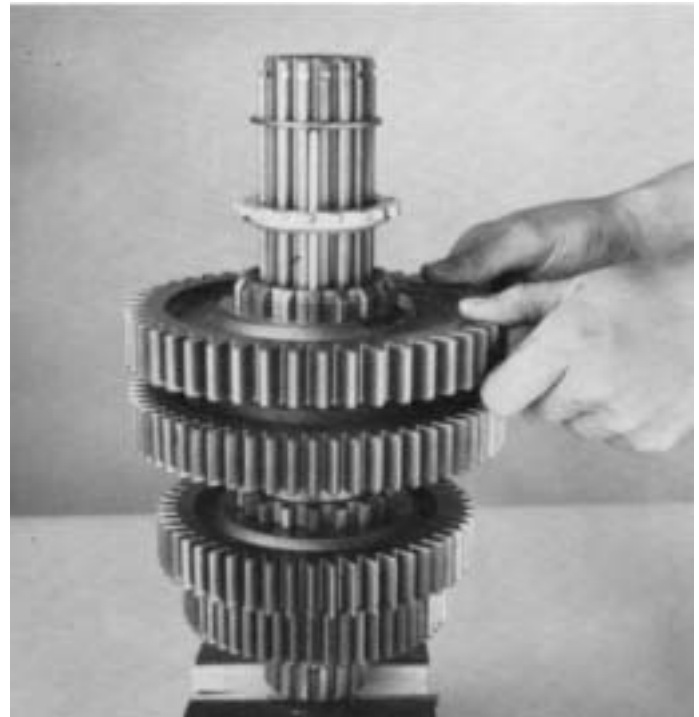

26. Remove the snap ring from hub of reverse gear and reinstall the gear on mainshaft. Engage the clutching teeth of gear with the splines of spacer and sliding clutch and move the reverse gear against the 1st speed gear.

REASSEMBLY-FRONT SECTION



27. Remove the mainshaft assembly from vise. Align the missing internal spline of 3rd-4th speed sliding clutch with key in mainshaft and install on front of shaft, engaging the external splines of sliding clutch with clutching teeth of 3rd speed gear.

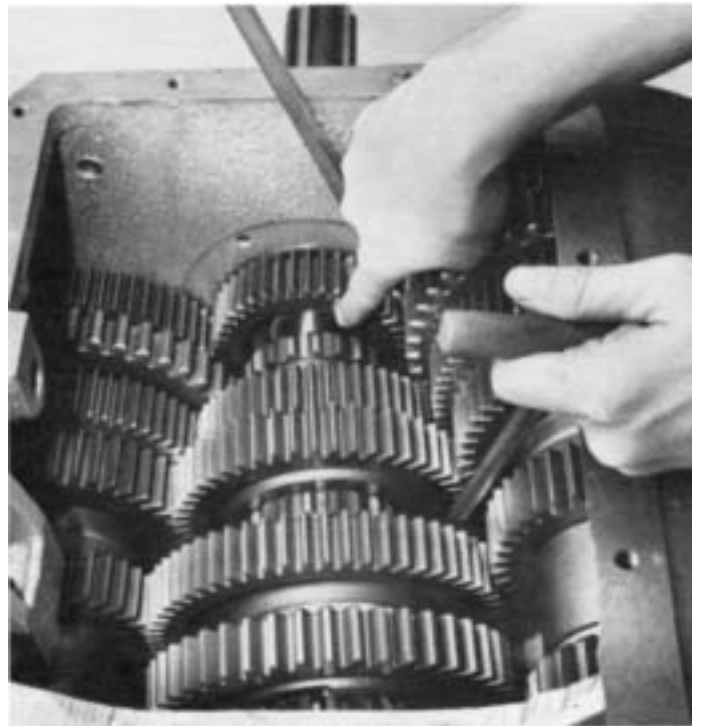

29. Move the pilot-end of mainshaft into pocket bushing of input shaft.

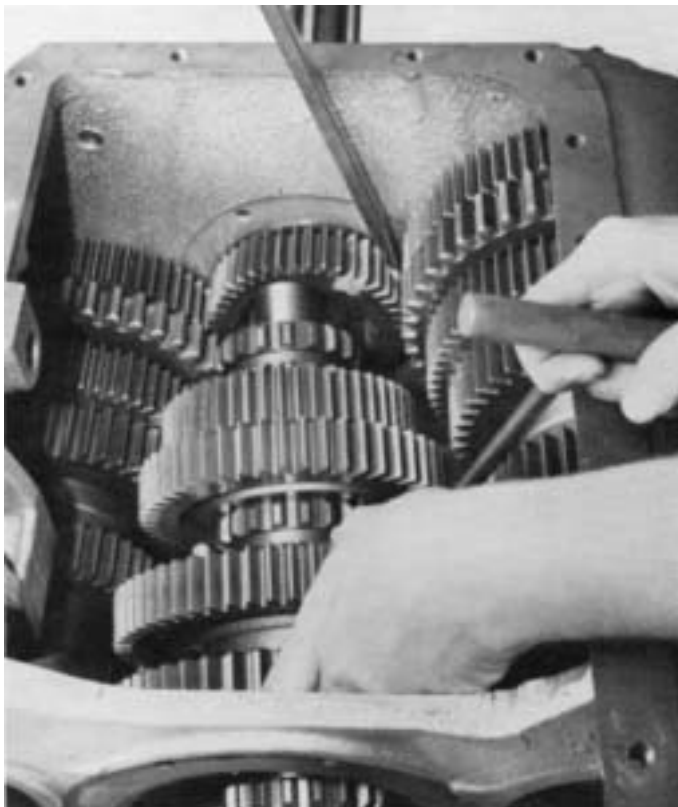

28. Block the right countershaft assembly against case wall and lower the mainshaft assembly into position with the reverse gear held against spacer and rear of shaft moved into case bore.

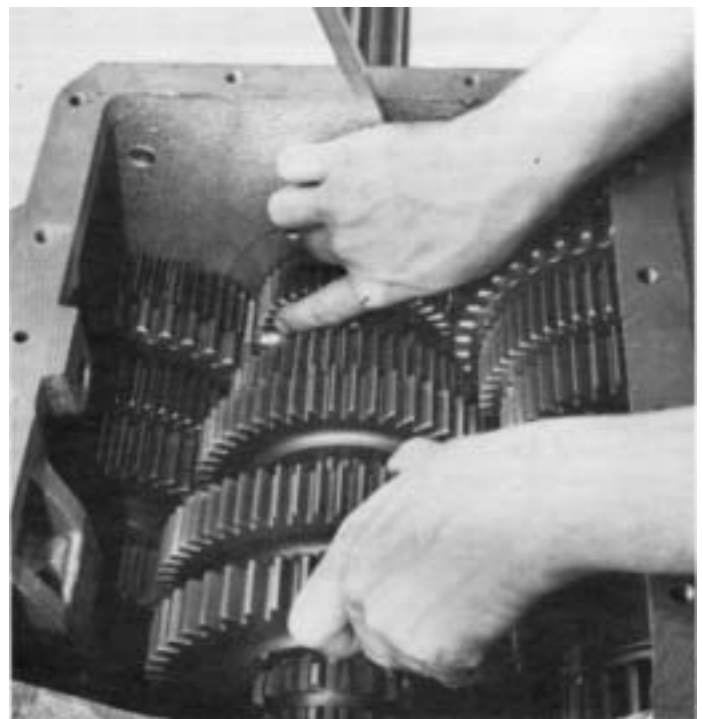

30. With the reverse gear remaining against spacer, mesh corresponding forward speed gears of left countershaft assembly. Check to make sure that marked tooth on left countershaft drive gear has remained in mesh with marked set of teeth on main drive gear.

REASSEMBLY-FRONT SECTION

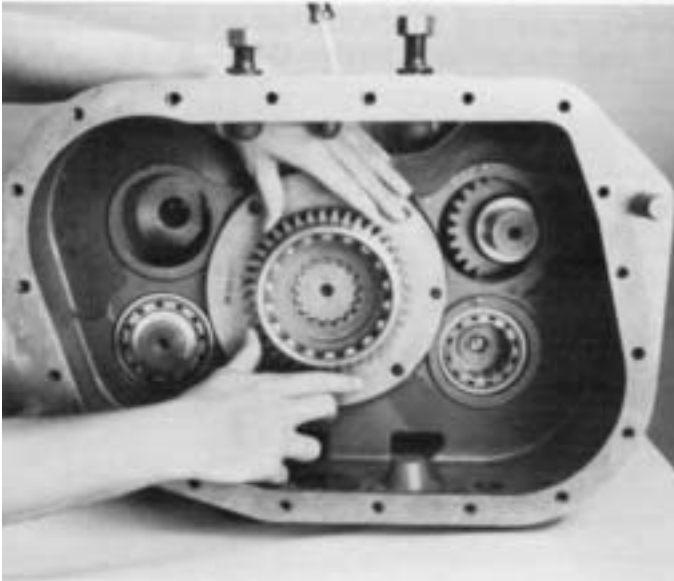

31. Center rear of mainshaft in case bore and install auxiliary drive gear assembly on shaft, partially seating bearing in bore. **DO NOT COMPLETE INSTALLATION AT THIS TIME.**

H. Bearing Installation and Timing of Right Countershaft Assembly

IMPORTANT: The left countershaft assembly MUST remain in time with main drive gear when timing right countershaft assembly.

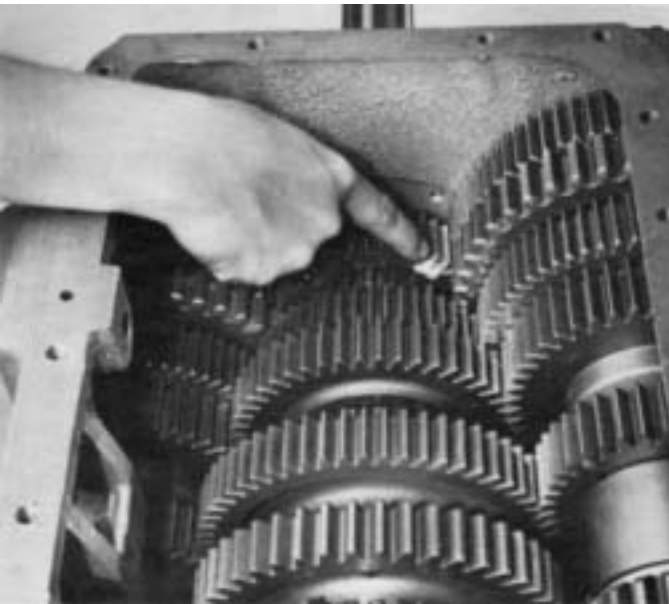

1. Remove blocking from right countershaft assembly and place it parallel to mainshaft assembly. Mesh the marked tooth of right countershaft drive gear with remaining set of two marked teeth on main drive gear.

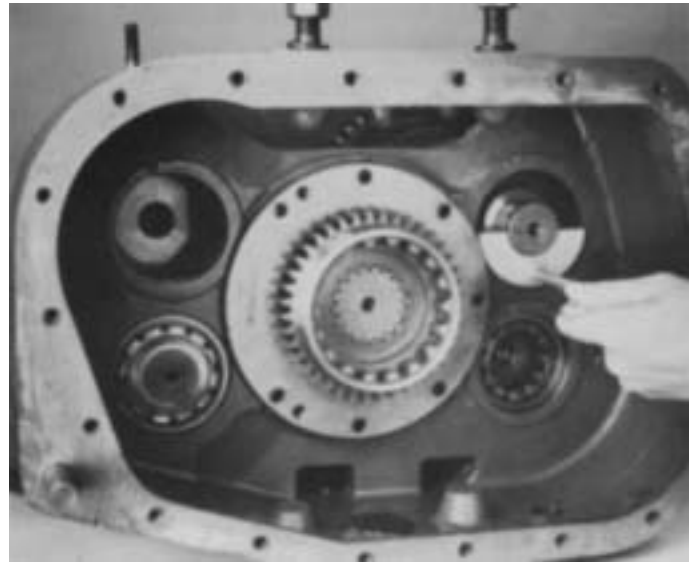

2. Insert countershaft support tool in rear bearing bore.

3. Install right countershaft bearings in the same manner described in Part D for left countershaft bearings.

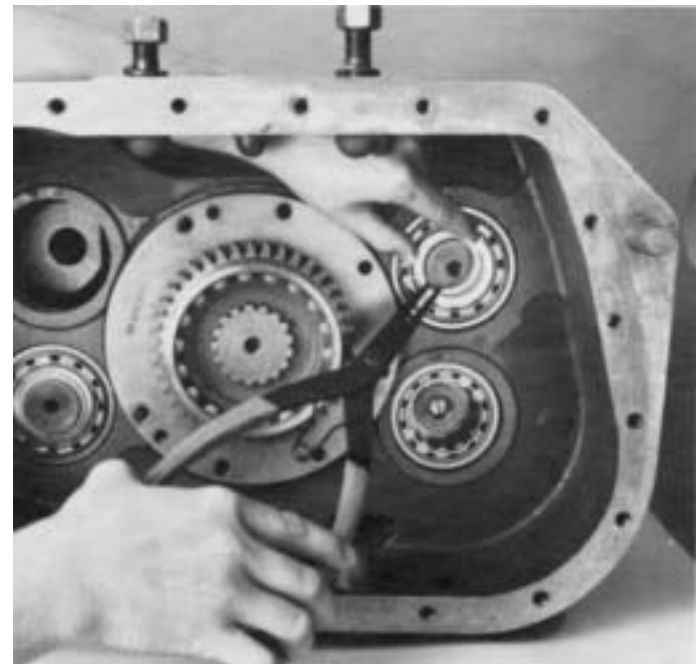

4. With bearing installation complete, install snap ring in groove at rear of right countershaft.

REASSEMBLY-FRONT SECTION

1. Reassembly and Installation of Left Reverse Idler Gear Assembly

NOTE: Since the left and right reverse idler gear assemblies are identical, reassembly and installation of the left reverse idler gear assembly should be performed at this time as described in Part A of this section.

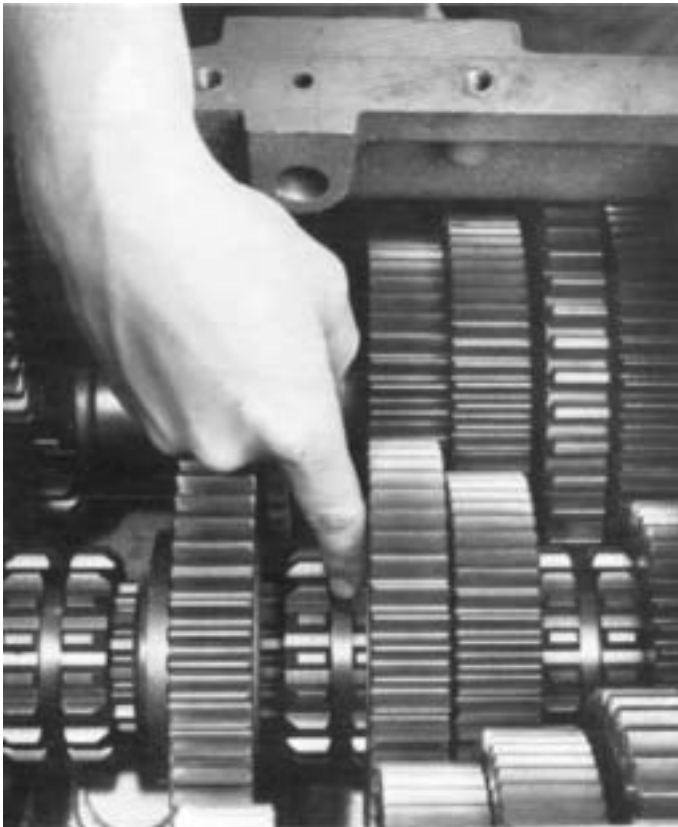

1. Move reverse gear to the rear on mainshaft and engage sliding clutches with all forward speed gears. A sliding clutch that will not engage with a gear indicates the gear set is not in proper mesh. The bearings of the right countershaft would then need to be removed and the drive gear set retimed.

NOTE: Do not engage sliding clutches with more than one gear at the same time. This will lock the gearing and prevent the mainshaft and countershaft assemblies from rotating.

J. Completed Installation of Mainshaft and Auxiliary Drive Gear Assemblies

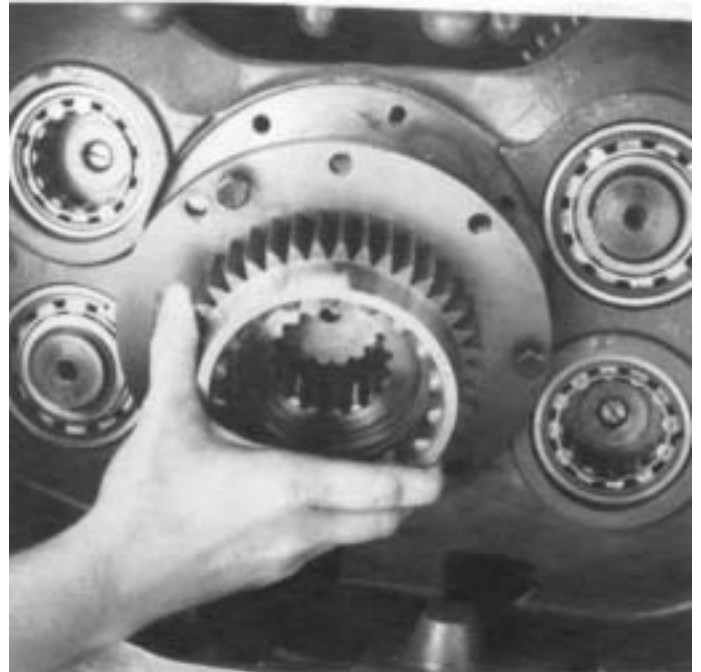

1. Remove auxiliary drive gear assembly from mainshaft and rear bearing bore. Do not allow mainshaft to move to rear when removing auxiliary drive gear.

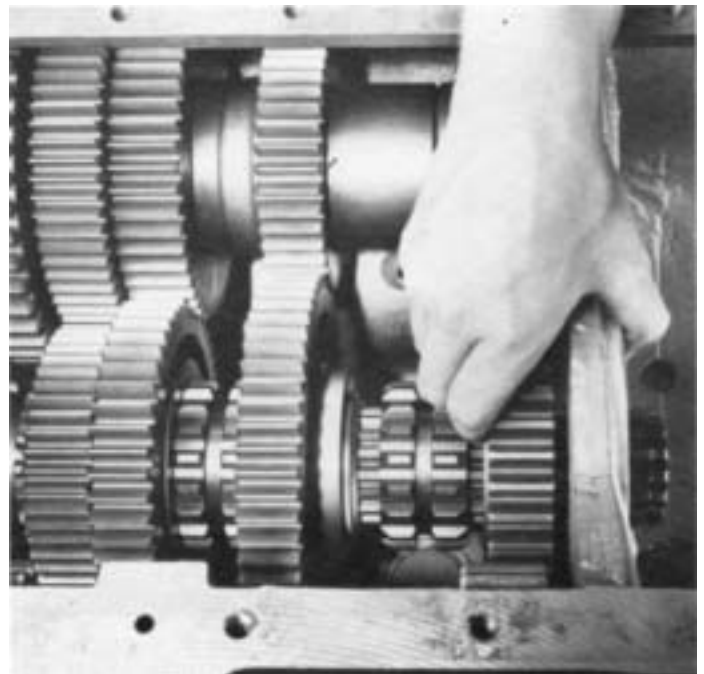

2. Move reverse gear to the rear as far as possible, meshing teeth of gear with those of the reverse idler gears.

REASSEMBLY-FRONT SECTION

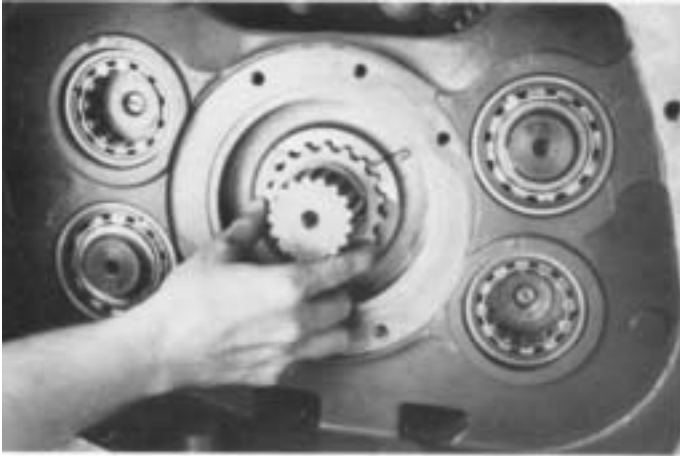

3. Align external splines of spacer with clutching teeth of reverse gear and move spacer forward on mainshaft and into gear.



4. Install snap ring in hub of reverse gear and move reverse gear forward on mainshaft and into proper position in case.



5. Reinstall the auxiliary drive gear assembly on rear of mainshaft. Use a flanged-end driver and maul to seat bearing in case bore.

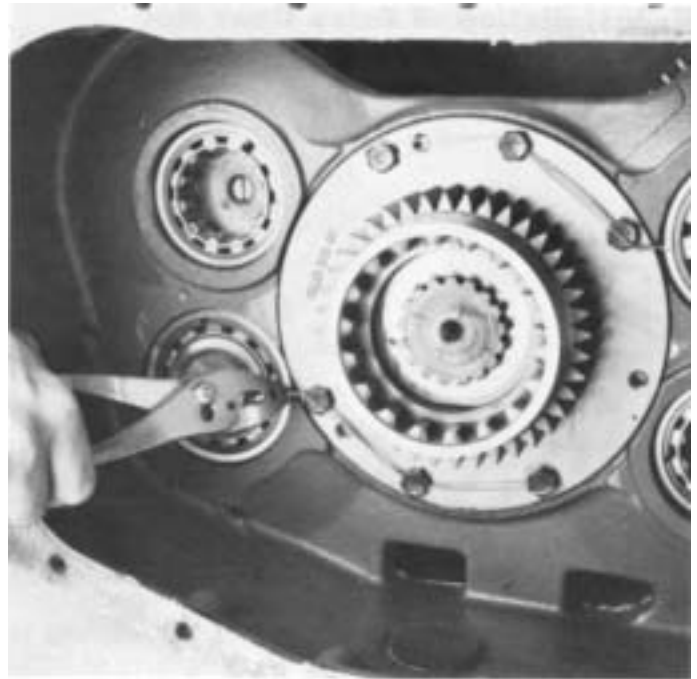

6. Align the six capscrew holes in retainer with tapped holes in case and install capscrews. Tighten to 35-45 lbs./ft. and lockwire capscrews in groups of three as shown.

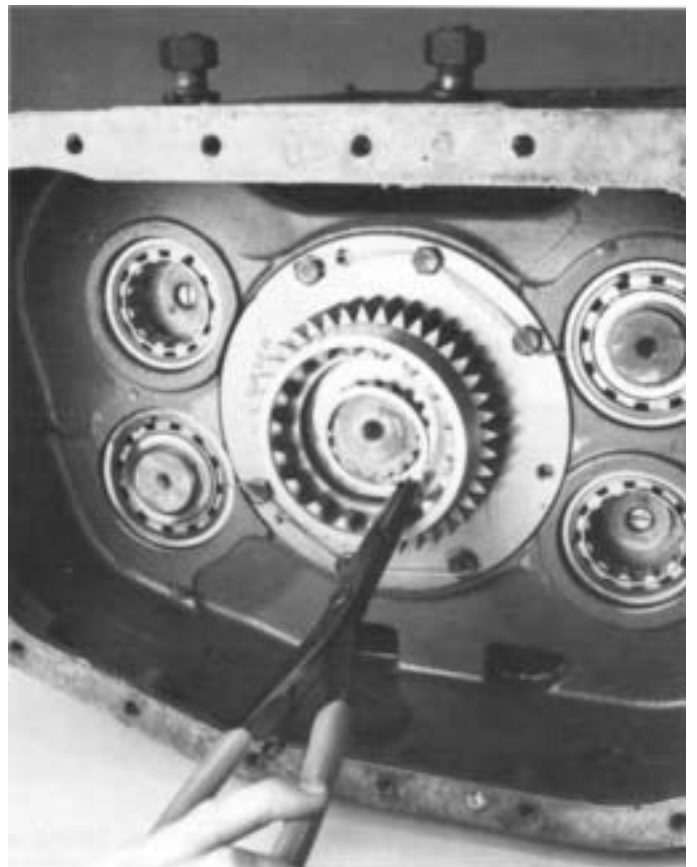

7. Install snap ring in groove at end of mainshaft.

REASSEMBLY-FRONT SECTION

K. Installation of Drive Gear Nut and Front Bearing Cover



1. Apply Loctite grade 277 sealant to cleaned threads of new drive gear bearing nut. DO NOT REUSE OLD NUT.

NOTE: For models equipped with a snap ring to retain bearing, install snap ring in groove of input shaft and proceed to No. 4.



2. Engage two mainshaft sliding clutches into gear to prevent transmission from rotating.

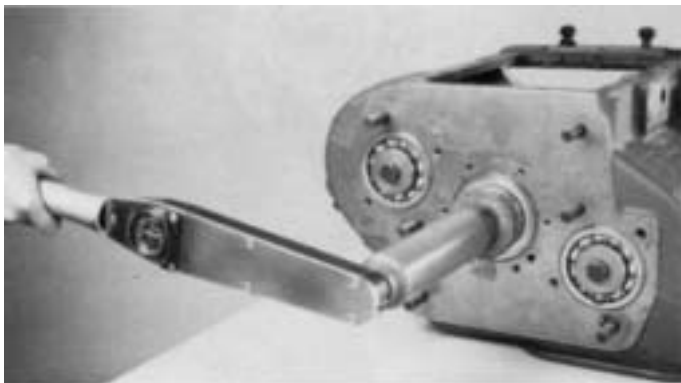

3. Install nut on shaft (left hand threads). Using a drive gear nut installer, tighten to 250-300 lbs/ft of torque. Use a punch and maul to peen the nut into the two milled slots of input shaft.



4. If previously removed, install the oil seal in drive gear bearing cover of models so equipped.

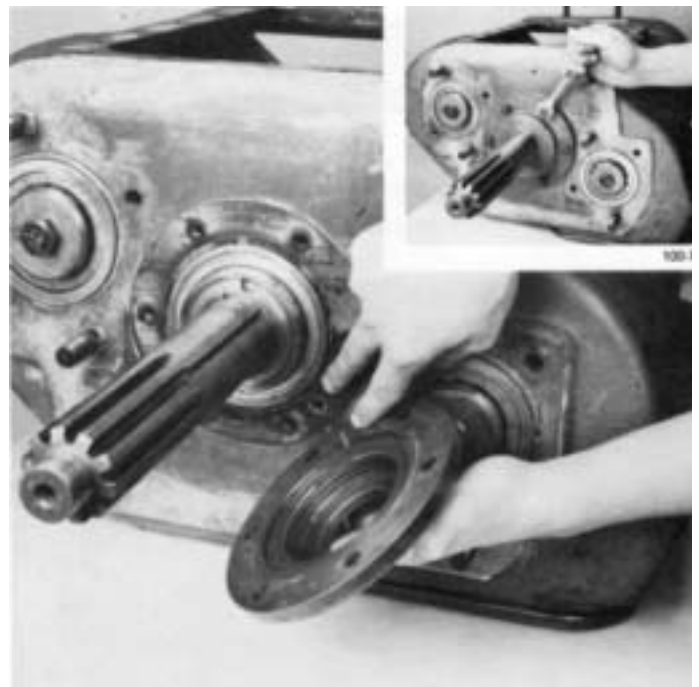

5. Install drive gear bearing cover and gasket, making sure to align the oil return hole in case. Secure cover on case with retaining cap screws (inset).

INSTALLATION-COMPANION FLANGE, AUXILIARY SECTION AND CLUTCH HOUSING

COMPANION FLANGE AUXILIARY SECTION AND CLUTCH HOUSING

A. Installation of Clutch Housing

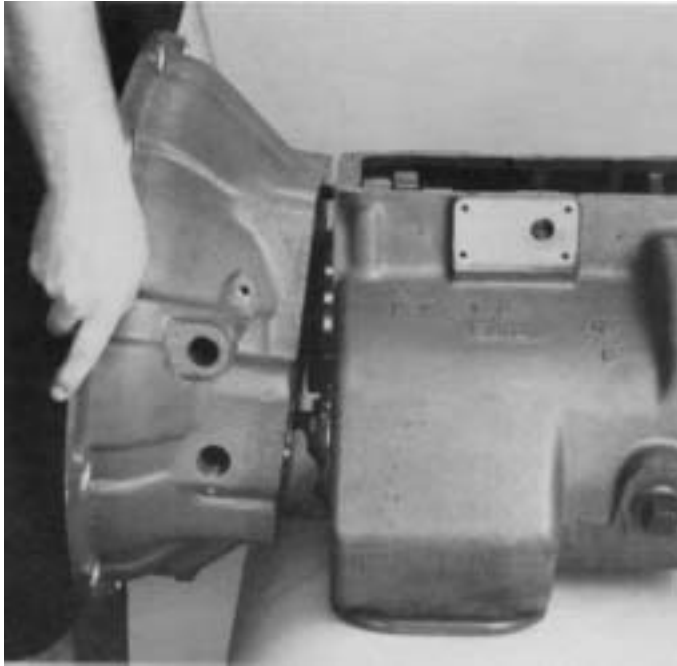

1. Position corresponding new gasket on housing mounting surface and install clutch housing on front case, piloting on six studs and drive gear bearing cover.

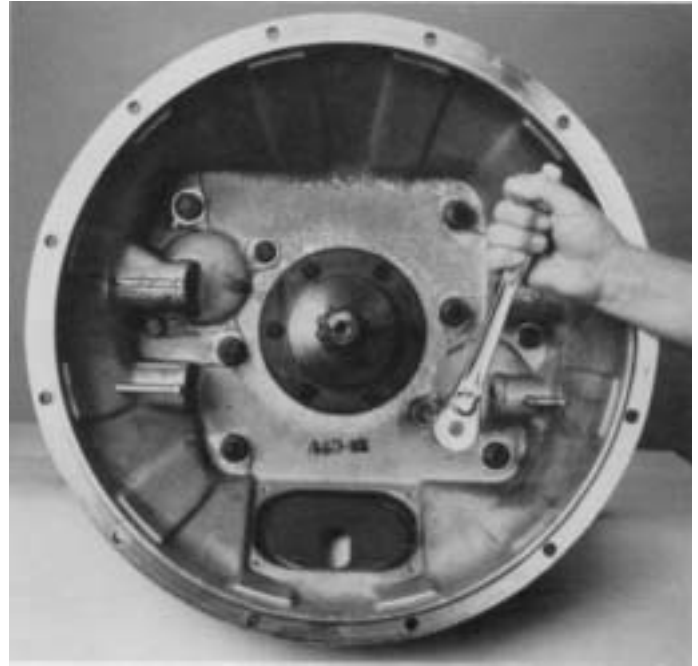

3. Install four cap screws with lockwashers and tighten to 90-100 lbs./ft. iron housing, 70-75 lbs./ft. aluminum housing.
4. For models so equipped, install the clutch release mechanism and/or clutch brake assembly. See OPTIONS.

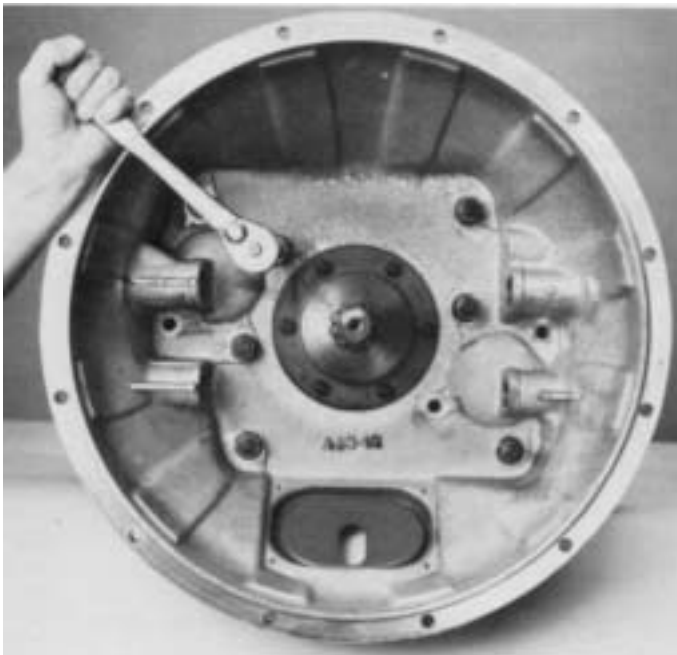

2. Install six nuts with washers or lockwashers on studs and tighten to 180-190 lbs./ft. iron housing, 170-175 lbs./ft. aluminum housing.

INSTALLATION-COMPANION FLANGE, AUXILIARY SECTION AND CLUTCH HOUSING

B. Installation of Auxiliary Section

NOTE: Make sure the bearing inner race is installed on front of each auxiliary countershaft BEFORE proceeding with the following.

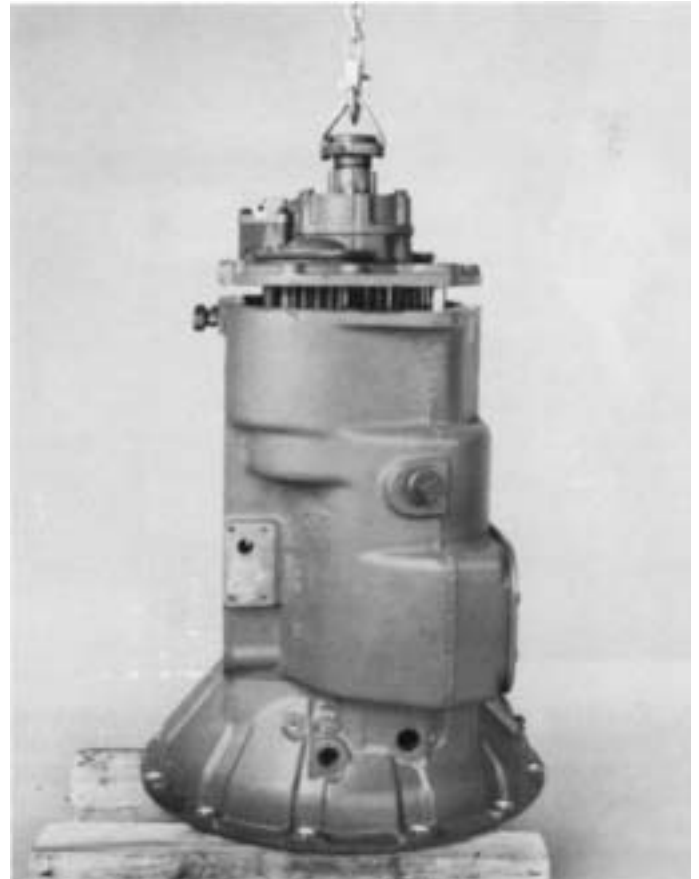
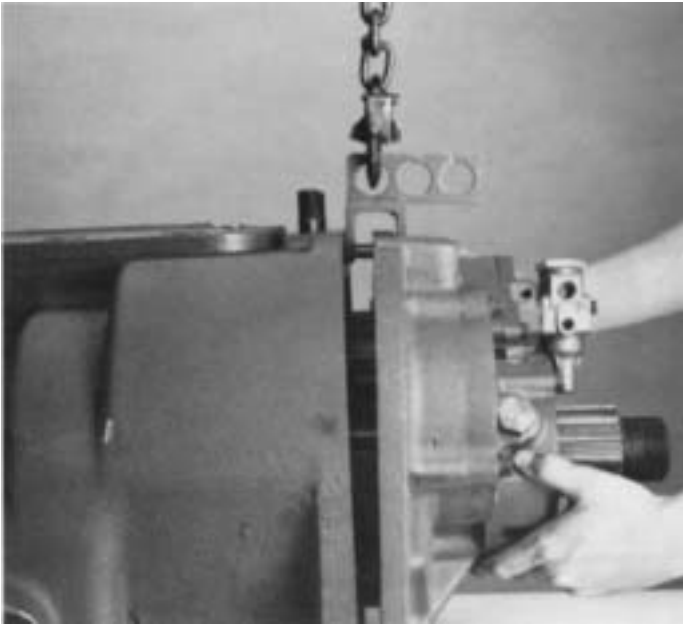

1. Attach a chain hoist to auxiliary. Move assembly evenly into rear of front case, piloting it on the dowel pins. As assembly is moved forward, the countershaft drive gears will mesh with the auxiliary drive gear.

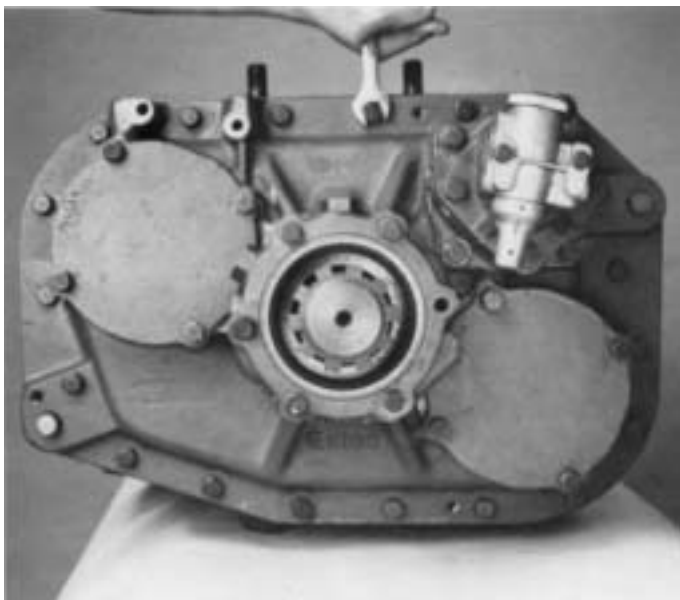

3. The auxiliary section can also be installed with transmission set in the vertical position. Block under clutch housing to prevent damage to input shaft, position corresponding new gasket on housing mounting surface and lower assembly onto rear of front case. Install retaining cap screws and tighten to 35-45 lbs./ft.

2. Install retaining capscrews in flange of auxiliary housing and tighten to 35-45 lbs./ft. to secure the auxiliary section to front section.

INSTALLATION-COMPANION FLANGE, AUXILIARY SECTION AND CLUTCH HOUSING

C. Installation of Universal Joint Companion Flange or Yoke



1. For models so equipped, install the speedometer drive gear or replacement spacer in position on hub of companion flange or yoke. Install the companion flange or yoke on splines of output shaft and move into rear bearing cover.

NOTE: For 14608 models, the speedometer drive gear or replacement spacer is installed on output shaft prior to installation of rear bearing cover.

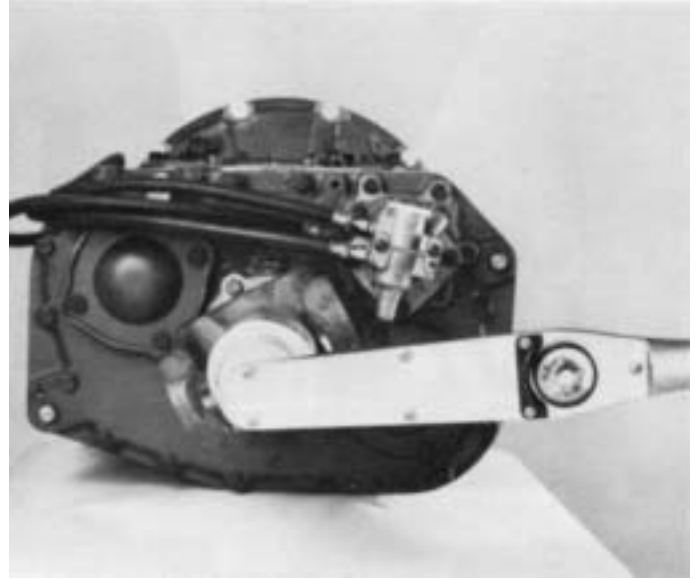

2. Lock the transmission by engaging two main shaft gears with sliding clutches. Install the washer and/or nut on output shaft and tighten nut using 450-500 lbs/ft of torque.

INSTALLATION- SHIFTING CONTROLS

SHIFT BAR HOUSING ASSEMBLY

A. Installation

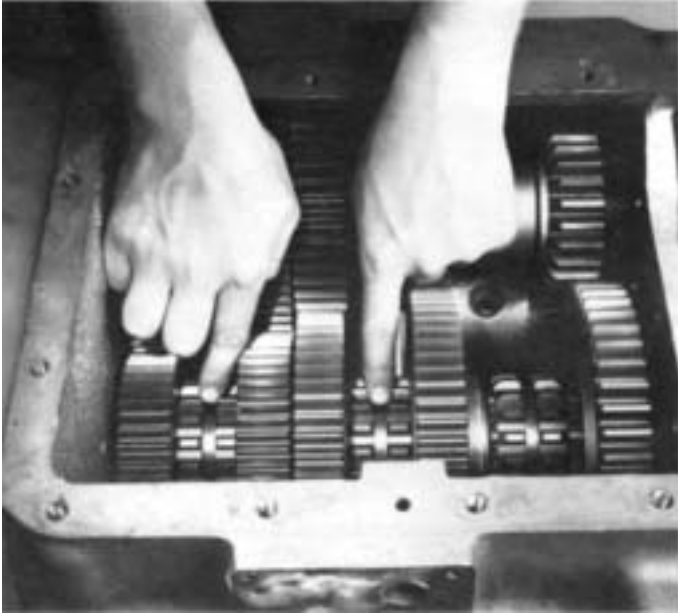

1. Place all three mainshaft sliding clutches in the neutral position.

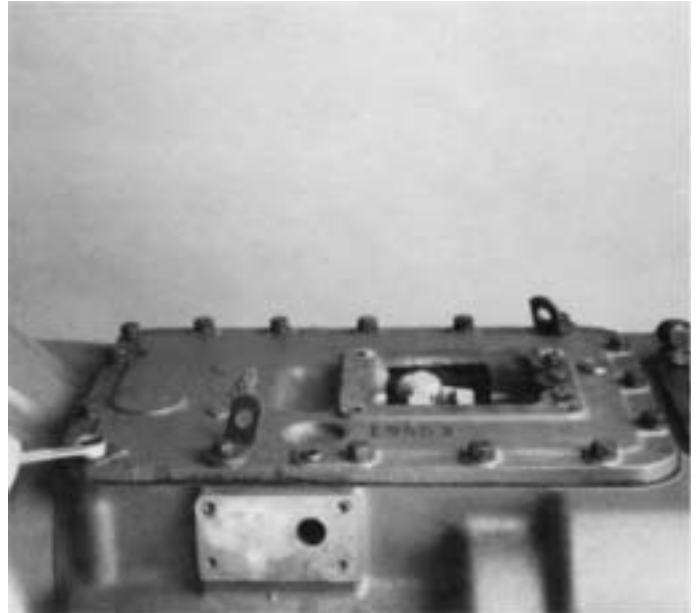

3. Install the capscrews in housing and torque to 35-45 lbs./ft.

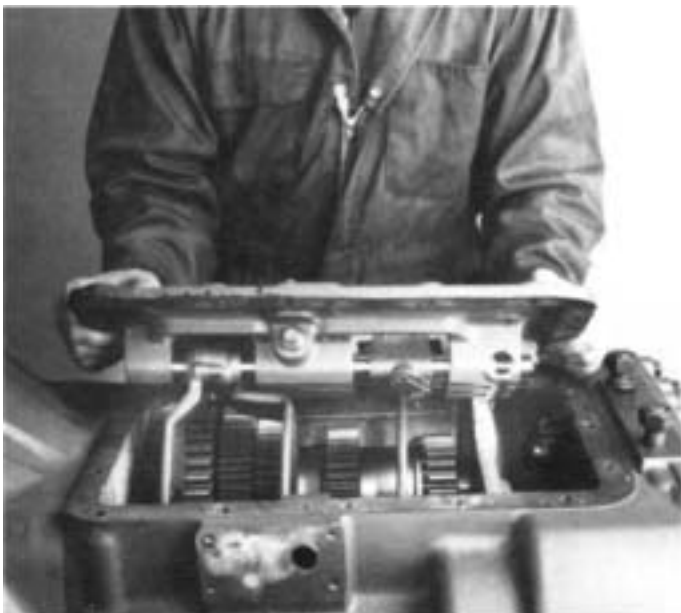

Install new shift bar housing gasket in position on case.

2. With all three shift bars in the neutral position, install shift bar housing assembly on case, fitting the shift yokes into slots of corresponding sliding clutches.

NOTE: Avoid tilting assembly during installation as the three sets of tension springs and balls are free to be released from bores in top of housing.

INSTALLATION- SHIFTING CONTROLS

GEAR SHIFT LEVER HOUSING ASSEMBLY

A. Installation

NOTE: For models equipped with a LRC or SRC Assembly, the housing is installed in the same manner described in the following instructions.

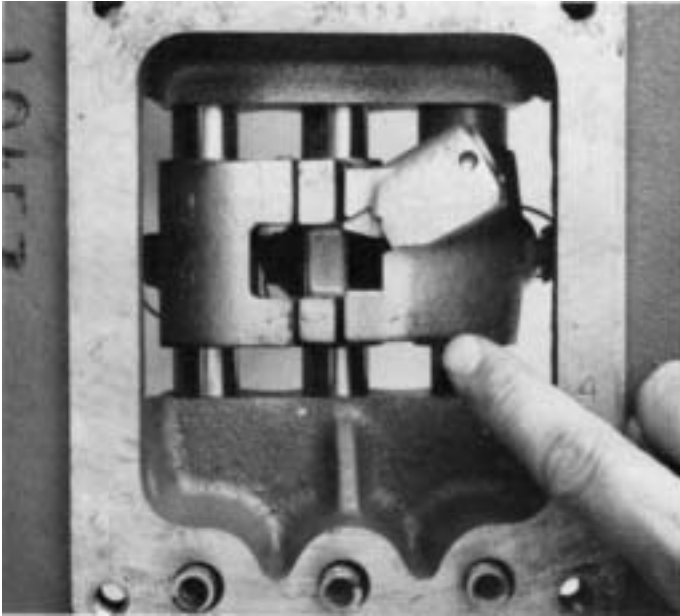

1. Check shift bar housing assembly to make sure shift block and yoke notches are aligned in the neutral position.



3. Install retaining cap screws in housing flange and torque to 35-45 lbs./ft.



2. Install new gear shift lever housing gasket in position on shift bar housing and install the gear shift lever housing assembly on shift bar housing, fitting lever into shift block and yoke notches.

INSTALLATION- SHIFTING CONTROLS

AIR SYSTEMS

A. Installation of Slave Valve

NOTE: 19470 slave valve shown, for other combinations see air systems schematics on page 25.



1. If previously removed, install air line fittings on slave valve.



2. Install spring on shank of actuating pin and insert in bore of transmission case.

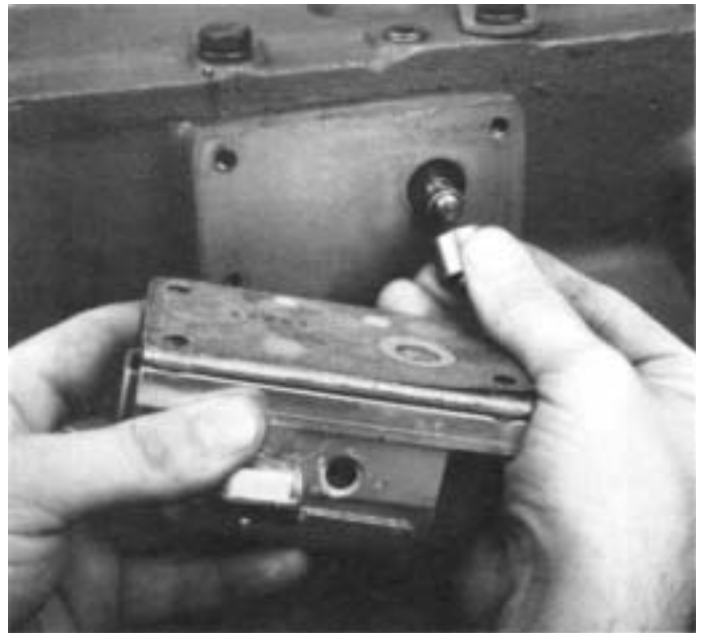

3. Install hat-type alignment sleeve in bore valve.

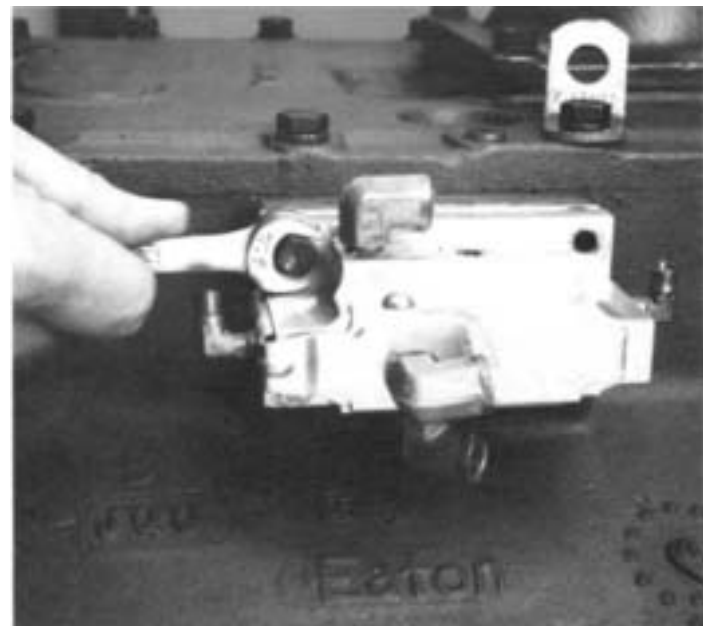

4. Position corresponding new gasket on valve mounting surface and install slave valve on case, inserting the end of actuating pin into alignment sleeve. Secure the valve to case with four retaining capscrews tightened evenly to 8-12 lbs./ft.

B. Installation of Air Lines

(See Air System Schematics on pages 25-26.)

Copyright Eaton Corporation, 2012. Eaton hereby grant their customers, vendors, or distributors permission to freely copy, reproduce and/or distribute this document in printed format. It may be copied only in its entirety without any changes or modifications. THIS INFORMATION IS NOT INTENDED FOR SALE OR RESALE, AND THIS NOTICE MUST REMAIN ON ALL COPIES.

Note: Features and specifications listed in this document are subject to change without notice and represent the maximum capabilities of the software and products with all options installed. Although every attempt has been made to ensure the accuracy of information contained within, Eaton makes no representation about the completeness, correctness or accuracy and assumes no responsibility for any errors or omissions. Features and functionality may vary depending on selected options.

For spec'ing or service assistance, call 1-800-826-HELP (4357) or visit www.eaton.com/roadranger. In Mexico, call 001-800-826-4357.

Roadranger: Eaton and trusted partners providing the best products and services in the industry, ensuring more time on the road.

Eaton Corporation

Vehicle Group
P.O. Box 4013
Kalamazoo, MI 49003 USA
800-826-HELP (4357)
www.eaton.com/roadranger

Printed in USA